

GRAND VICTORIA III

維港滙 III

SALES BROCHURE 售樓說明書

GRAND VICTORIA III

維港滙 III

You are advised to take the following steps before purchasing first-hand residential properties.

For all first-hand residential properties

1. Important information

- Make reference to the materials available on the Sales of First-hand Residential Properties Electronic Platform (SRPE) (www.srpe.gov.hk) on the first-hand residential property market.
- Study the information on the website designated by the Vendor for the development, including the sales brochure, price lists, documents containing the sales arrangements, and the register of transactions of a development.
- Sales brochure for a development will be made available to the general public at least 7 days immediately before a date of sale while price list and sales arrangements will be made available at least 3 days immediately before the date of sale.
- Information on transactions can be found on the register of transactions on the website designated by the Vendor for the development and the SRPE.

2. Fees, mortgage loan and property price

- Calculate the total expenses of the purchase, such as solicitors' fees, mortgage charges, insurance fees and stamp duties.
- Check with banks to find out if you will be able to obtain the needed mortgage loan, select the appropriate payment method and calculate the amount of the mortgage loan to ensure it is within your repayment ability.
- Check recent transaction prices of comparable properties for comparison.

- Check with the Vendor or the estate agent the estimated management fee, the amount of management fee payable in advance (if any), special fund payable (if any), the amount of reimbursement of the deposits for water, electricity and gas (if any), and/or the amount of debris removal fee (if any) you have to pay to the Vendor or the manager of the development.

3. Price list, payment terms and other financial incentives

- Vendors may not offer to sell all the residential properties that are covered in a price list. To know which residential properties the Vendors may offer to sell, pay attention to the sales arrangements which will be announced by the Vendors at least 3 days before the relevant residential properties are offered to be sold.
- Pay attention to the terms of payment as set out in a price list. If there are discounts on the price, gift, or any financial advantage or benefit to be made available in connection with the purchase of the residential properties, such information will also be set out in the price list.
- If you intend to opt for any mortgage loan plans offered by financial institutions specified by the Vendor, before entering into a preliminary agreement for sale and purchase (PASP), you must study the details of various mortgage loan plans¹ as set out in the price list concerned. If you have any questions about these mortgage loan plans, you should check with the financial institutions concerned direct before entering into a PASP.

¹ The details of various mortgage loan plans include the requirements for mortgagors on minimum income level, the loan limit under the first mortgage and second mortgage, the maximum loan repayment period, the change of mortgage interest rate throughout the entire repayment period, and the payment of administrative fees.

4. Property area and its surroundings

- Pay attention to the area information in the sales brochure and price list, and price per square foot/metre in the price list. According to the Residential Properties (First-hand Sales) Ordinance (Cap. 621) (the Ordinance), Vendors can only present the area and price per square foot and per square metre of a residential property using saleable area. Saleable area, in relation to a residential property, means the floor area of the residential property, and includes the floor area of every one of the following to the extent that it forms part of the residential property - (i) a balcony; (ii) a utility platform; and (iii) a verandah. The saleable area excludes the area of the following which forms part of the residential property - air-conditioning plant room; bay window; cockloft; flat roof; garden; parking space; roof; stairhood; terrace and yard.
- Floor plans of all residential properties in the development have to be shown in the sales brochure. In a sales brochure, floor plans of residential properties in the development must state the external and internal dimensions of each residential property². The external and internal dimensions of residential properties as provided in the sales brochure exclude plaster and finishes. You are advised to note this if you want to buy furniture before handing over of the residential property.
- Visit the development site and get to know the surroundings of the property (including transportation and community facilities). Check town planning proposals and decisions which may affect the property. Take a look at the location plan, aerial photograph, outline zoning plan and cross-section plan that are provided in the sales brochure.

² According to section 10(2)(d) in Part 1 of Schedule 1 to the Ordinance, each of the floor plans of the residential properties in the development in the sales brochure must state the following—

- the external dimensions of each residential property;
- the internal dimensions of each residential property;
- the thickness of the internal partitions of each residential property;
- the external dimensions of individual compartments in each residential property.

According to section 10(3) in Part 1 of Schedule 1 to the Ordinance, if any information required by section 10(2)(d) in Part 1 of Schedule 1 to the Ordinance is provided in the approved building plans for the development, a floor plan must state the information as so provided.

5. Sales brochure

- Ensure that the sales brochure you have obtained is the latest version. According to the Ordinance, the sales brochure made available to the public should be printed or examined, or examined and revised within the previous 3 months.
- Read through the sales brochure and in particular, check the following information in the sales brochure -
 - whether there is a section on “relevant information” in the sales brochure, under which information on any matter that is known to the Vendor but is not known to the general public, and is likely to materially affect the enjoyment of a residential property will be set out. Please note that information contained in a document that has been registered with the Land Registry will not be regarded as “relevant information”;
 - the cross-section plan showing a cross-section of the building in relation to every street adjacent to the building, and the level of every such street in relation to a known datum and to the level of the lowest residential floor of the building. This will help you visualize the difference in height between the lowest residential floor of a building and the street level, regardless of how that lowest residential floor is named;
 - interior and exterior fittings and finishes and appliances;
 - the basis on which management fees are shared;
 - whether individual owners have obligations or need to share the expenses for managing, operating and maintaining the public open space or public facilities inside or outside the development, and the location of the public open space or public facilities; and
 - whether individual owners have responsibility to maintain slopes.

6. Government land grant and deed of mutual covenant (DMC)

- Read the Government land grant and the DMC (or the draft DMC). Information such as ownership of the rooftop and external walls can be found in the DMC. The Vendor will provide copies of the Government land grant and the DMC (or the draft DMC) at the place where the sale is to take place for free inspection by prospective purchasers.
- Check the Government land grant on whether individual owners are liable to pay Government rent.
- Check the DMC on whether animals can be kept in the residential property.

7. Information on Availability of Residential Properties for Selection at Sales Office

- Check with the Vendor which residential properties are available for selection. If a “consumption table” is displayed by the Vendor at the sales office, you may check from the table information on the progress of sale on a date of sale, including which residential properties are offered for sale at the beginning of that date of sale and which of them have been selected and sold during that date of sale.
- Do not believe in rumours about the sales condition of the development and enter into a PASP rashly.

8. Register of Transactions

- Pay attention to the register of transactions for a development. A Vendor must, within 24 hours after entering into a PASP with a purchaser, enter transaction information of the PASP in the register of transactions. The Vendor must, within 1 working day after entering into an agreement for sale and purchase (ASP), enter transaction information of the ASP in the register of transactions. Check the register of transactions for the concerned development to learn more about the sales condition of the development.

- Never take the number of registrations of intent or cashier orders a Vendor has received for the purpose of registration as an indicator of the sales volume of a development. The register of transactions for a development is the most reliable source of information from which members of the public can grasp the daily sales condition of the development.

9. Agreement for sale and purchase

- Ensure that the PASP and ASP include the mandatory provisions as required by the Ordinance.
- Pay attention that fittings, finishes and appliances to be included in the sale and purchase of the property are inserted in the PASP and ASP.
- Pay attention to the area plan annexed to the ASP which shows the total area which the Vendor is selling to you. The total area which the Vendor is selling to you is normally greater than the saleable area of the property.
- A preliminary deposit of **5%** of the purchase price is payable by you to the owner (i.e. the seller) on entering into a PASP.
- If you do not execute the ASP within **5 working days** (working day means a day that is not a general holiday or a Saturday or a black rainstorm warning day or gale warning day) after entering into the PASP, the PASP is terminated, the preliminary deposit (i.e. 5% of the purchase price) is forfeited, and the owner (i.e. the seller) does not have any further claim against you for not executing the ASP.
- If you execute the ASP within 5 working days after the signing of the PASP, the owner (i.e. the seller) must execute the ASP within 8 working days after entering into the PASP.
- The deposit should be made payable to the solicitors’ firm responsible for stakeholding purchasers’ payments for the property.

10. Expression of intent of purchasing a residential property

- Note that Vendors (including their authorized representative(s)) should not seek or accept any specific or general expression of intent of purchasing any residential property before the relevant price lists for such properties are made available to the public. You therefore should not make such an offer to the Vendors or their authorized representative(s).
- Note that Vendors (including their authorized representative(s)) should not seek or accept any specific expression of intent of purchasing a particular residential property before the sale of the property has commenced. You therefore should not make such an offer to the Vendors or their authorized representative(s).

11. Appointment of estate agent

- Note that if the Vendor has appointed one or more than one estate agents to act in the sale of any specified residential property in the development, the price list for the development must set out the name of all the estate agents so appointed as at the date of printing of the price list.
- You may appoint any estate agent (not necessarily from those estate agency companies appointed by the Vendor) to act in the purchase of any specified residential property in the development, and may also not appoint any estate agent to act on your behalf.
- Before you appoint an estate agent to look for a property, you should -
 - find out whether the agent will act on your behalf only. If the agent also acts for the Vendor, he/she may not be able to protect your best interests in the event of a conflict of interest;
 - find out whether any commission is payable by you to the estate agent and, if so, its amount and the time of payment; and

- note that only licensed estate agents or salespersons may accept your appointment. If in doubt, you should request the estate agent or salesperson to produce his/her Estate Agent Card, or check the Licence List on the Estate Agents Authority website: www.eaa.org.hk.

12. Appointment of solicitor

- Consider appointing your own solicitor to protect your interests. If the solicitor also acts for the Vendor, he/she may not be able to protect your best interests in the event of a conflict of interest.
- Compare the charges of different solicitors.

For first-hand uncompleted residential properties**13. Pre-sale Consent**

- For uncompleted residential property under the Lands Department Consent Scheme, seek confirmation from the Vendor whether the “Pre-sale Consent” has been issued by the Lands Department for the development.

14. Show flats

- While the Vendor is not required to make any show flat available for viewing by prospective purchasers or the general public, if the Vendor wishes to make available show flats of a specified residential property, the Vendor must first of all make available an unmodified show flat of that residential property and that, having made available such unmodified show flat, the Vendor may then make available a modified show flat of that residential property. In this connection, the Vendor is allowed to make available more than one modified show flat of that residential property.

³ Generally speaking, “material date” means the date on which the conditions of the land grant are complied with in respect of the development, or the date on which the development is completed in all respects in compliance with the approved building plans or the conditions subject to which the certificate of exemption is issued. For details, please refer to section 2 of the Ordinance.

- If you visit the show flats, you should always look at the unmodified show flats for comparison with the modified show flats. That said, the Ordinance does not restrict the discretion of the Vendor in arranging the sequence of the viewing of unmodified and modified show flats.
- Sales brochure of the development should have been made available to the public when the show flat is made available for viewing. You are advised to get a copy of the sales brochure and make reference to it when viewing the show flats.
- You may take measurements in modified and unmodified show flats, and take photographs or make video recordings of unmodified show flats, subject to reasonable restriction(s) which may be set by the Vendor for ensuring safety of the persons viewing the show flat.

For first-hand uncompleted residential properties and completed residential properties pending compliance**15. Estimated material date and handing over date**

- Check the estimated material date³ for the development in the sales brochure.
 - The estimated material date for a development in the sales brochure is not the same as the date on which a residential property is handed over to purchaser. The latter is inevitably later than the former.
- Handing over date
 - The mandatory provisions to be incorporated in an ASP as required by the Ordinance include a provision requiring the Vendor to apply in writing for an Occupation Document/a Certificate of Compliance or the Director of Lands’ Consent to Assign (as the case may be) in respect of the development within 14 days after the estimated material date as stipulated in the ASP.

- For development subject to the Lands Department Consent Scheme, the Vendor is required to notify the purchaser in writing that the Vendor is in a position validly to assign the property within one month after the issue of the Certificate of Compliance or the Consent to Assign, whichever first happens; or
 - For development not subject to the Lands Department Consent Scheme, the Vendor is required to notify the purchaser in writing that the Vendor is in a position validly to assign the property within 6 months after the issue of the Occupation Document including Occupation Permit.
- The mandatory provisions to be incorporated in an ASP as required by the Ordinance include a provision requiring completion of the sale and purchase within 14 days after the date of the notification aforesaid. Upon completion, the Vendor shall arrange handover of the property to the purchaser.
- Authorized Person (AP) may grant extension(s) of time for completion of the development beyond the estimated material date.
- The mandatory provisions to be incorporated in an ASP as required by the Ordinance include a provision that the AP of a development may grant an extension of time for completion of the development beyond the estimated material date having regard to delays caused exclusively by any one or more of the following reasons:
 - strike or lock-out of workmen;
 - riots or civil commotion;
 - force majeure or Act of God;
 - fire or other accident beyond the Vendor's control;
- war; or
 - inclement weather.
- The AP may grant more than once such an extension of time depending on the circumstances. That means handover of the property may be delayed.
 - The mandatory provisions to be incorporated in an ASP as required by the Ordinance also include a provision requiring the Vendor to, within 14 days after the issue of an extension of time granted by the AP, furnish the purchaser with a copy of the relevant certificate of extension.
- Ask the Vendor if there are any questions on handing over date.

For first-hand completed residential properties

16. Vendor's information form

- Ensure that you obtain the "Vendor's information form(s)" printed within the previous 3 months in relation to the residential property/properties you intend to purchase.

17. Viewing of property

- Ensure that, before you purchase a residential property, you are arranged to view the residential property that you would like to purchase or, if it is not reasonably practicable to view the property in question, a comparable property in the development, unless you agree in writing that the Vendor is not required to arrange such a comparable property for viewing for you. You are advised to think carefully before signing any waiver.
- You may take measurements, take photographs or make video recordings of the property, unless the property is held under a tenancy or reasonable restriction(s) is/are needed to ensure safety of the persons viewing the property.

For complaints and enquiries relating to the sales of first-hand residential properties by the Vendors which the Ordinance applies, please contact the Sales of First-hand Residential Properties Authority

-

Website	: www.srpa.gov.hk
Telephone	: 2817 3313
Email	: enquiry_srpa@hd.gov.hk
Fax	: 2219 2220

Other useful contacts:

Consumer Council	
Website	: www.consumer.org.hk
Telephone	: 2929 2222
Email	: cc@consumer.org.hk
Fax	: 2856 3611
Estate Agents Authority	
Website	: www.eaa.org.hk
Telephone	: 2111 2777
Email	: enquiry@eaa.org.hk
Fax	: 2598 9596
Real Estate Developers Association of Hong Kong	
Telephone	: 2826 0111
Fax	: 2845 2521

Sales of First-hand Residential Properties Authority
 Transport and Housing Bureau
 August 2017

您在購置一手住宅物業之前，應留意下列事項：

適用於所有一手住宅物業

1. 重要資訊

- 瀏覽一手住宅物業銷售資訊網（下稱「銷售資訊網」）（網址：www.srpe.gov.hk），參考「銷售資訊網」內有關一手住宅物業的市場資料。
- 閱覽賣方就該發展項目所指定的互聯網網站內的有關資訊，包括售樓說明書、價單、載有銷售安排的文件，及成交紀錄冊。
- 發展項目的售樓說明書，會在該項目的出售日期前最少七日向公眾發布，而有關價單和銷售安排，亦會在該項目的出售日期前最少三日公布。
- 在賣方就有關發展項目所指定的互聯網網站，以及「銷售資訊網」內，均載有有關物業成交資料的成交紀錄冊，以供查閱。

2. 費用、按揭貸款和樓價

- 計算置業總開支，包括律師費、按揭費用、保險費，以及印花稅。
- 向銀行查詢可否取得所需的按揭貸款，然後選擇合適的還款方式，並小心計算按揭貸款金額，以確保貸款額沒有超出本身的負擔能力。
- 查閱同類物業最近的成交價格，以作比較。
- 向賣方或地產代理瞭解，您須付予賣方或該發展項目的管理人的預計的管理費、管理費上期金額（如有）、特別基金金額（如有）、補還的水、電力及氣體按金（如有）、以及/或清理廢料的費用（如有）。

3. 價單、支付條款，以及其他財務優惠

- 賣方未必會把價單所涵蓋的住宅物業悉數推售，因此應留意有關的銷售安排，以了解賣方會推售的住宅物業為何。賣方會在有關住宅物業推售日期前最少三日公布銷售安排。
- 留意價單所載列的支付條款。倘買家可就購置有關住宅物業而連帶獲得價格折扣、贈品，或任何財務優惠或利益，上述資訊亦會在價單內列明。
- 如您擬選用由賣方指定的財務機構提供的各類按揭貸款計劃，在簽訂臨時買賣合約前，應先細閱有關價單內列出的按揭貸款計劃資料¹。如就該些按揭貸款計劃的詳情有任何疑問，應在簽訂臨時買賣合約前，直接向有關財務機構查詢。

4. 物業的面積及四周環境

- 留意載於售樓說明書和價單內的物業面積資料，以及載於價單內的每平方呎/每平方米售價。根據《一手住宅物業銷售條例》（第621章）（下稱「條例」），賣方只可以實用面積表達住宅物業的面積和每平方呎及平方米的售價。就住宅物業而言，實用面積指該住宅物業的樓面面積，包括在構成該物業的一部分的範圍內的以下每一項目的樓面面積：(i) 露台；(ii) 工作平台；以及 (iii) 陽台。實用面積並不包括空調機房、窗台、閣樓、平台、花園、停車位、天台、梯屋、前庭或庭院的每一項目的面積，即使該些項目構成該物業的一部分的範圍。
- 售樓說明書必須顯示發展項目中所有住宅物業的樓面平面圖。在售樓說明書所載有關發展項目中住宅物業的每一份樓面平面圖，均須述明每個住宅物業的外部 and 內部尺寸²。售樓說明書所提供有關住宅物業外部和內部的尺寸，不會把批盪和裝飾物料包括在內。買家收樓前如欲購置家具，應留意這點。

¹ 按揭貸款計劃的資料包括有關按揭貸款計劃對借款人的最低收入的要求、就第一按揭連同第二按揭可獲得的按揭貸款金額上限、最長還款年期、整個還款期內的按揭利率變化，以及申請人須繳付的手續費。

- 親臨發展項目的所在地實地視察，以了解有關物業的四周環境（包括交通和社區設施）；亦應查詢有否任何城市規劃方案和議決，會對有關的物業造成影響；參閱載於售樓說明書內的位置圖、鳥瞰照片、分區計劃大綱圖，以及橫截面圖。

5. 售樓說明書

- 確保所取得的售樓說明書屬最新版本。根據條例，提供予公眾的售樓說明書必須是在之前的三個月之內印製或檢視、或檢視及修改。
- 閱覽售樓說明書，並須特別留意以下資訊：
 - 售樓說明書內有否關於「有關資料」的部分，列出賣方知悉但並非為一般公眾人士所知悉，關於相當可能對享用有關住宅物業造成重大影響的事宜的資料。請注意，已在土地註冊處註冊的文件，其內容不會被視為「有關資料」；
 - 橫截面圖會顯示有關建築物相對毗連該建築物的每條街道的橫截面，以及每條上述街道與已知基準面和該建築物最低的一層住宅樓層的水平相對的水平。橫截面圖能以圖解形式，顯示出建築物最低一層住宅樓層和街道水平的高低差距，不論該最低住宅樓層以何種方式命名；
 - 室內和外部的裝置、裝修物料和設備；
 - 管理費按甚麼基準分擔；
 - 小業主有否責任或需要分擔管理、營運或維持有關發展項目以內或以外的公眾休憩用地或公共設

² 根據條例附表1第1部第10(2)(d)條述明，售樓說明書內顯示的發展項目中的住宅物業的每一份樓面平面圖須述明以下各項—

- 每個住宅物業的外部尺寸；
- 每個住宅物業的內部尺寸；
- 每個住宅物業的內部間隔的厚度；
- 每個住宅物業內個別分隔室的外部尺寸。

根據條例附表1第1部第10(3)條，如有關發展項目的經批准的建築圖則，提供條例附表1第1部第10(2)(d)條所規定的資料，樓面平面圖須述明如此規定的該資料。

施的開支，以及有關公眾休憩用地或公共設施的位置；以及

- 小業主是否須要負責維修斜坡。

6. 政府批地文件和公契

- 閱覽政府批地文件和公契（或公契擬稿）。公契內載有天台和外牆業權等相關資料。賣方會在售樓處提供政府批地文件和公契（或公契擬稿）的複本，供準買家免費閱覽。
- 留意政府批地文件內所訂明小業主是否須要負責支付地稅。
- 留意公契內訂明有關物業內可否飼養動物。

7. 售樓處內有關可供揀選住宅物業的資料

- 向賣方查詢清楚有哪些一手住宅物業可供揀選。若賣方在售樓處內展示「消耗表」，您可從該「消耗表」得悉在每個銷售日的銷售進度資料，包括在該個銷售日開始時有哪些住宅物業可供出售，以及在該個銷售日內有哪些住宅物業已獲揀選及售出。
- 切勿隨便相信有關發展項目銷情的傳言，倉卒簽立臨時買賣合約。

8. 成交紀錄冊

- 留意發展項目的成交紀錄冊。賣方須於臨時買賣合約訂立後的24小時內，於紀錄冊披露該臨時買賣合約的資料，以及於買賣合約訂立後一個工作天內，披露該買賣合約的資料。您可透過成交紀錄冊得悉發展項目的銷售情況。
- 切勿將賣方接獲用作登記的購樓意向書或本票的數目視為銷情指標。發展項目的成交紀錄冊才是讓公眾掌握發展項目每日銷售情況的最可靠資料來源。

9. 買賣合約

- 確保臨時買賣合約和買賣合約包含條例所規定的強制性條文。
- 留意有關物業買賣交易所包括的裝置、裝修物料和設備，須在臨時買賣合約和買賣合約上列明。
- 留意夾附於買賣合約的圖則。該圖則會顯示所有賣方售予您的物業面積，而該面積通常較該物業的實用面積為大。
- 訂立臨時買賣合約時，您須向擁有人（即賣方）支付樓價**5%**的臨時訂金。
- 如您在訂立臨時買賣合約後**五個工作日**（工作日指並非公眾假日、星期六、黑色暴雨警告日或烈風警告日的日子）之內，沒有簽立買賣合約，該臨時買賣合約即告終止，有關臨時訂金（即樓價的5%）會被沒收，而擁有人（即賣方）不得因您沒有簽立買賣合約而對您提出進一步申索。
- 在訂立臨時買賣合約後的五個工作日之內，倘您簽立買賣合約，則擁有人（即賣方）必須在訂立該臨時買賣合約後的八個工作日之內簽立買賣合約。
- 有關的訂金，應付予負責為所涉物業擔任保證金保存人的律師事務所。

10. 表達購樓意向

- 留意在賣方（包括其獲授權代表）就有關住宅物業向公眾提供價單前，賣方不得尋求或接納任何對有關住宅物業的購樓意向（不論是否屬明確選擇購樓意向）。因此您不應向賣方或其授權代表提出有關意向。
- 留意在有關住宅物業的銷售開始前，賣方（包括其獲授權代表）不得尋求或接納任何對該物業的有明確選擇購樓意向。因此您不應向賣方或其授權代表提出有關意向。

11. 委託地產代理

- 留意倘賣方委任一個或多於一個地產代理，以協助銷售其發展項目內任何指明住宅物業，該發展項目的價單必須列明在價單印刷日期當日所有獲委任為地產代理的姓名/名稱。
- 您可委託任何地產代理（不一定是賣方所指定的地產代理），以協助您購置發展項目內任何指明住宅物業；您亦可不委託任何地產代理。
- 委託地產代理以物色物業前，您應該 —
 - 了解該地產代理是否只代表您行事。該地產代理若同時代表賣方行事，倘發生利益衝突，未必能夠保障您的最大利益；
 - 了解您須否支付佣金予該地產代理。若須支付，有關的佣金金額和支付日期為何；以及
 - 留意只有持牌地產代理或營業員才可以接受您的委託。如有疑問，應要求該地產代理或營業員出示其「地產代理證」，或瀏覽地產代理監管局的網頁（網址：www.eaa.org.hk），查閱牌照目錄。

12. 委聘律師

- 考慮自行委聘律師，以保障您的利益。該律師若同時代表賣方行事，倘發生利益衝突，未必能夠保障您的最大利益。
- 比較不同律師的收費。

適用於一手未落成住宅物業

13. 預售樓花同意書

- 洽購地政總署「預售樓花同意方案」下的未落成住宅物業時，應向賣方確認地政總署是否已就該發展項目批出「預售樓花同意書」。

14. 示範單位

- 賣方不一定須設置示範單位供準買家或公眾參觀，但賣方如為某指明住宅物業設置示範單位，必須首先設置該住宅物業的無改動示範單位，才可設置該住宅物業的經改動示範單位，並可以就該住宅物業設置多於一個經改動示範單位。
- 參觀示範單位時，務必視察無改動示範單位，以便與經改動示範單位作出比較。然而，條例並沒有限制賣方安排參觀無改動示範單位及經改動示範單位的先後次序。
- 賣方設置示範單位供公眾參觀時，應已提供有關發展項目的售樓說明書。因此，緊記先行索取售樓說明書，以便在參觀示範單位時參閱相關資料。
- 您可以在無改動示範單位及經改動示範單位中進行量度，並在無改動示範單位內拍照或拍攝影片，惟在確保示範單位參觀者人身安全的前提下，賣方可能會設定合理的限制。

適用於一手未落成住宅物業及尚待符合條件的已落成住宅物業

15. 預計關鍵日期及收樓日期

- 查閱售樓說明書中有關發展項目的預計關鍵日期³。
 - 售樓說明書中有關發展項目的預計關鍵日期並不同買家的「收樓日期」。買家的「收樓日期」必定較發展項目的預計關鍵日期遲。
- 收樓日期
 - 條例規定買賣合約須載有強制性條文，列明賣方須於買賣合約內列出的預計關鍵日期後的14日內，以書面為發展項目申請佔用文件、合格證明書，或地政總署署長的轉讓同意（視屬何種情況而定）。

- 如發展項目屬地政總署預售樓花同意方案所規管，賣方須在合格證明書或地政總署署長的轉讓同意發出後的一個月內（以較早者為準），就賣方有能力有效地轉讓有關物業一事，以書面通知買家；或

- 如發展項目並非屬地政總署預售樓花同意方案所規管，賣方須在佔用文件（包括佔用許可證）發出後的六個月內，就賣方有能力有效地轉讓有關物業一事，以書面通知買家。

- 條例規定買賣合約須載有強制性條文，列明有關物業的買賣須於賣方發出上述通知的日期的14日內完成。有關物業的買賣完成後，賣方將安排買家收樓事宜。

- 認可人士可批予在預計關鍵日期之後完成發展項目

- 條例規定買賣合約須載有強制性條文，列明發展項目的認可人士可以在顧及純粹由以下一個或多於一個原因所導致的延遲後，批予在預計關鍵日期之後，完成發展項目：

- 工人罷工或封閉工地；
- 暴動或內亂；
- 不可抗力或天災；
- 火警或其他賣方所不能控制的意外；
- 戰爭；或
- 惡劣天氣。

- 發展項目的認可人士可以按情況，多於一次批予延後預計關鍵日期以完成發展項目，即收樓日期可能延遲。

- 條例規定買賣合約須載有強制性條文，列明賣方須於認可人士批予延期後的14日內，向買家提供有關延期證明書的文本。

- 如對收樓日期有任何疑問，可向賣方查詢。

適用於一手已落成住宅物業

16. 賣方資料表格

- 確保取得最近三個月內印製有關您擬購買的一手已落成住宅物業的「賣方資料表格」。

17. 參觀物業

- 購置住宅物業前，確保已獲安排參觀您打算購置的住宅物業。倘參觀有關物業並非合理地切實可行，則應參觀與有關物業相若的物業，除非您以書面同意賣方無須開放與有關物業相若的物業供您參觀。您應仔細考慮，然後才決定是否簽署豁免上述規定的書面同意。
- 除非有關物業根據租約持有，或為確保物業參觀者的人身安全而須設定合理限制，您可以對該物業進行量度、拍照或拍攝影片。

任何與賣方銷售受條例所規管的一手住宅物業有關的投訴和查詢，請與一手住宅物業銷售監管局聯絡。

網址	: www.srpa.gov.hk
電話	: 2817 3313
電郵	: enquiry_srpa@hd.gov.hk
傳真	: 2219 2220

³ 一般而言，「關鍵日期」指該項目符合批地文件的條件的日期，或該項目在遵照經批准的建築圖則的情況下或按照豁免證明書的發出的條件在各方面均屬完成的日期。有關詳情請參閱條例第2條。

其他相關聯絡資料：

消費者委員會	
網址	: www.consumer.org.hk
電話	: 2929 2222
電郵	: cc@consumer.org.hk
傳真	: 2856 3611
地產代理監管局	
網址	: www.eaa.org.hk
電話	: 2111 2777
電郵	: enquiry@eaa.org.hk
傳真	: 2598 9596
香港地產建設商會	
電話	: 2826 0111
傳真	: 2845 2521

運輸及房屋局
一手住宅物業銷售監管局
2017年8月

Name of the Phase of the Development

GRAND VICTORIA (“Development”), the Phase 3 of which is called “GRAND VICTORIA III” (the “Phase”)

Name of the street at which the Phase is situated and the street number allocated by the Commissioner of Rating and Valuation for the purpose of distinguishing the Phase

6 Lai Ying Street and 8 Lai Ying Street

The provisional street number is subject to confirmation when the Phase is completed.

Total number of storeys of each multi-unit building

Phase 3 Tower 1(1A & 1B) : 29 Storeys

Phase 3 Tower 2 : 29 Storeys

The above number of storeys does not include B2/F, B1/F, Roof, Lower Roof, Upper Roof & Top Roof.

Floor numbering in each multi-unit building as provided in the approved building plans for the Phase

Phase 3 Tower 1(1A & 1B):

B2/F, B1/F, G/F, 1/F-3/F, 5/F-12/F, 15/F-23/F, 25/F-32/F, Roof, Lower Roof, Upper Roof & Top Roof

Phase 3 Tower 2:

B2/F, B1/F, G/F, 1/F-3/F, 5/F-12/F, 15/F-23/F, 25/F-32/F, Roof, Lower Roof, Upper Roof & Top Roof

Omitted floor numbers in each multi-unit building in which the floor numbering is not in consecutive order

4/F, 13/F, 14/F, 24/F (All Towers)

Refuge floors (if any) of each multi-unit building

Phase 3 Tower 1(1A & 1B) & Phase 3 Tower 2: Roof

Estimated material date for the Phase as provided by the Authorized Person for the Phase

31 May 2023

The estimated material date is subject to any extension of time that is permitted under the agreement for sale and purchase. Under the land grant, the consent of the Director of Lands is required to be given for the sale and purchase. For the purpose of the agreement for sale and purchase, without limiting any other means by which the completion of the Phase may be proved, the issue of a certificate of compliance or consent to assign by the Director of Lands is conclusive evidence that the Phase has been completed or is deemed to be completed (as the case may be).

發展項目的期數的名稱

維港滙 (「發展項目」) 的第3期稱為「維港滙 III」 (「期數」)

期數所位於的街道名稱及由差餉物業估價署署長為識別期數的目的而編配的門牌號數

荔盈街6號及荔盈街8號

此臨時門牌號數有待期數建成時確認。

每幢多單位建築物的樓層的總數

第3期 第1座(1A & 1B) : 29 層

第3期 第2座 : 29 層

上述樓層數目並不包括地庫2層、地庫1層、天台、低層天台、上層天台及頂層天台。

期數的經批准的建築圖則所規定的每幢多單位建築物內的樓層號數

第3期 第1座(1A & 1B) :

地庫2層、地庫1層、地下、1樓至3樓、5樓至12樓、15樓至23樓、25樓至32樓、天台、低層天台、上層天台及頂層天台

第3期 第2座 :

地庫2層、地庫1層、地下、1樓至3樓、5樓至12樓、15樓至23樓、25樓至32樓、天台、低層天台、上層天台及頂層天台

每幢有不依連續次序的樓層號數的多單位建築物內被略去的樓層號數

4樓、13樓、14樓、24樓 (所有座數)

每幢多單位建築物內的庇護層 (如有的話)

第3期 第1座(1A & 1B)及第3期 第2座 : 天台

期數的認可人士提供的期數的預計關鍵日期

2023年5月31日

預計關鍵日期，是受到買賣合約所允許的任何延期所規限的。根據批地文件，進行該項買賣，需獲地政總署署長同意。為買賣合約的目的，在不局限任何其他可用以證明該期數落成的方法的原則下，地政總署署長發出的合格證明書或轉讓同意，即為該期數已落成或當作已落成(視屬何種情況而定)的確證。

3

INFORMATION ON VENDOR AND OTHERS INVOLVED IN THE PHASE 賣方及有參與期數的其他人的資料

Vendor

Sky Asia Properties Limited

Holding company of the Vendor

Asia Bright Development Limited

Authorized Person for the Phase

Wong Min Hon Thomas

The firm or corporation of which an Authorized Person for the Phase is proprietor, director or employee in his or her professional capacity

Wong Tung & Partners Limited

Building contractor for the Phase

China Overseas Building Construction Limited

The firms of solicitors acting for the owner in relation to the sale of residential properties in the Phase

Woo Kwan Lee & Lo
Chu & Lau Solicitors & Notaries
Deacons
King & Wood Mallesons
Mayer Brown

Authorized institution that has made a loan, or has undertaken to provide finance, for the construction of the Phase

Bank of China (Hong Kong) Limited

Any other persons who have made a loan for the construction of the Phase

Central Wisdom Limited
Well Plant Limited
Enlightenment Harmony Limited
Nart Finance Limited
Fortune Spring Ventures Limited

賣方

天基置業有限公司

賣方的控權公司

加耀發展有限公司

期數的認可人士

黃明康

期數的認可人士以其專業身分擔任經營人、董事或僱員的商號或法團

王董建築師事務有限公司

期數的承建商

中國海外房屋工程有限公司

就期數中的住宅物業的出售而代表擁有人行事的律師事務所

胡關李羅律師行
劉漢銓律師行
的近律師行
金杜律師事務所
孖士打律師行

已為期數的建造提供貸款或已承諾為該項建造提供融資的認可機構

中國銀行(香港)有限公司

已為期數的建造提供貸款的任何其他人

廣明有限公司
耀廷有限公司
啟怡有限公司
Nart Finance Limited
Fortune Spring Ventures Limited

4

RELATIONSHIP BETWEEN PARTIES INVOLVED IN THE PHASE
有參與期數的各方的關係

(a)	The Vendor or a building contractor for the Phase is an individual, and that Vendor or contractor is an immediate family member of an Authorized Person for the Phase; 賣方或有關期數的承建商屬個人，並屬該期數的認可人士的家人；	Not applicable 不適用	(k)	The Vendor, a holding company of the Vendor, or a building contractor for the Phase, is a listed company, and such an Authorized Person, or such an associate, holds at least 1% of the issued shares in that Vendor, holding company or contractor; 賣方、賣方的控權公司或該期數的承建商屬上市公司，而上述認可人士或上述有聯繫人士持有該賣方、控權公司或承建商最少1%的已發行股份；	Not applicable 不適用
(b)	The Vendor or a building contractor for the Phase is a partnership, and a partner of that Vendor or contractor is an immediate family member of such an Authorized Person; 賣方或該期數的承建商屬合夥，而該賣方或承建商的合夥人屬上述認可人士的家人；	Not applicable 不適用	(l)	The Vendor or a building contractor for the Phase is a corporation, and such an Authorized Person, or such an associate, is an employee, director or secretary of that Vendor or contractor or of a holding company of that Vendor; 賣方或該期數的承建商屬法團，而上述認可人士或上述有聯繫人士屬該賣方、承建商或該賣方的控權公司的僱員、董事或秘書；	No 否
(c)	The Vendor or a building contractor for the Phase is a corporation, and a director or the secretary of that Vendor or contractor (or a holding company of that Vendor) is an immediate family member of such an Authorized Person; 賣方或該期數的承建商屬法團，而該賣方或承建商（或該賣方的控權公司）的董事或秘書屬上述認可人士的家人；	No 否	(m)	The Vendor or a building contractor for the Phase is a partnership, and such an Authorized Person, or such an associate, is an employee of that Vendor or contractor; 賣方或該期數的承建商屬合夥，而上述認可人士或上述有聯繫人士屬該賣方或承建商的僱員；	Not applicable 不適用
(d)	The Vendor or a building contractor for the Phase is an individual, and that Vendor or contractor is an immediate family member of an associate of such an Authorized Person; 賣方或該期數的承建商屬個人，並屬上述認可人士的有聯繫人士的家人；	Not applicable 不適用	(n)	The Vendor, a holding company of the Vendor, or a building contractor for the Phase, is a private company, and a proprietor of a firm of solicitors acting for the owner in relation to the sale of residential properties in the Phase holds at least 10% of the issued shares in that Vendor, holding company or contractor; 賣方、賣方的控權公司或該期數的承建商屬私人公司，而就該期數中的住宅物業的出售而代表擁有人行事的律師事務所的經營人持有該賣方、控權公司或承建商最少10%的已發行股份；	No 否
(e)	The Vendor or a building contractor for the Phase is a partnership, and a partner of that Vendor or contractor is an immediate family member of an associate of such an Authorized Person; 賣方或該期數的承建商屬合夥，而該賣方或承建商的合夥人屬上述認可人士的有聯繫人士的家人；	Not applicable 不適用	(o)	The Vendor, a holding company of the Vendor, or a building contractor for the Phase, is a listed company, and a proprietor of such a firm of solicitors holds at least 1% of the issued shares in that Vendor, holding company or contractor; 賣方、賣方的控權公司或該期數的承建商屬上市公司，而上述律師事務所的經營人持有該賣方、控權公司或承建商最少1%的已發行股份；	Not applicable 不適用
(f)	The Vendor or a building contractor for the Phase is a corporation, and a director or the secretary of that Vendor or contractor (or a holding company of that Vendor) is an immediate family member of an associate of such an Authorized Person; 賣方或該期數的承建商屬法團，而該賣方或承建商（或該賣方的控權公司）的董事或秘書屬上述認可人士的有聯繫人士的家人；	No 否	(p)	The Vendor or a building contractor for the Phase is a corporation, and a proprietor of such a firm of solicitors is an employee, director or secretary of that Vendor or contractor or of a holding company of that Vendor; 賣方或該期數的承建商屬法團，而上述律師事務所的經營人屬該賣方或承建商或該賣方的控權公司的僱員、董事或秘書；	No 否
(g)	The Vendor or a building contractor for the Phase is an individual, and that Vendor or contractor is an immediate family member of a proprietor of a firm of solicitors acting for the owner in relation to the sale of residential properties in the Phase; 賣方或該期數的承建商屬個人，並屬就該期數內的住宅物業的出售代表擁有人行事的律師事務所行事的經營人的家人；	Not applicable 不適用	(q)	The Vendor or a building contractor for the Phase is a partnership, and a proprietor of such a firm of solicitors is an employee of that Vendor or contractor; 賣方或該期數的承建商屬合夥，而上述律師事務所的經營人屬該賣方或承建商的僱員；	Not applicable 不適用
(h)	The Vendor or a building contractor for the Phase is a partnership, and a partner of that Vendor or contractor is an immediate family member of a proprietor of a firm of solicitors acting for the owner in relation to the sale of residential properties in the Phase; 賣方或該期數的承建商屬合夥，而該賣方或承建商的合夥人屬就該期數內的住宅物業的出售代表擁有人行事的律師事務所行事的經營人的家人；	Not applicable 不適用	(r)	The Vendor or a building contractor for the Phase is a corporation, and the corporation of which an Authorized Person for the Phase is a director or employee in his or her professional capacity is an associate corporation of that Vendor or contractor or of a holding company of that Vendor; 賣方或該期數的承建商屬法團，而該期數的認可人士以其專業身分擔任董事或僱員的法團為該賣方或承建商或該賣方的控權公司的有聯繫法團；	No 否
(i)	The Vendor or a building contractor for the Phase is a corporation, and a director or the secretary of that Vendor or contractor (or a holding company of that Vendor) is an immediate family member of a proprietor of such a firm of solicitors; 賣方或該期數的承建商屬法團，而該賣方或承建商（或該賣方的控權公司）的董事或秘書屬上述律師事務所的經營人的家人；	No 否	(s)	The Vendor or a building contractor for the Phase is a corporation, and that contractor is an associate corporation of that Vendor or of a holding company of that Vendor. 賣方或該期數的承建商屬法團，而該承建商屬該賣方或該賣方的控權公司的有聯繫法團。	No 否
(j)	The Vendor, a holding company of the Vendor, or a building contractor for the Phase, is a private company, and an Authorized Person for the Phase, or an associate of such an Authorized Person, holds at least 10% of the issued shares in that Vendor, holding company or contractor; 賣方、賣方的控權公司或有關期數的承建商屬私人公司，而該期數的認可人士或該認可人士的有聯繫人士持有該賣方、控權公司或承建商最少10%的已發行股份；	No 否			

There will be curtain walls forming part of the enclosing walls of the Phase.

期數將會有構成圍封牆的一部份的幕牆。

The thickness of the curtain walls of each building is 200mm.

每幢建築物的幕牆之厚度為200毫米。

Schedule of total area of the curtain walls of each residential property

每個住宅物業的幕牆的總面積表

Tower 座數	Floor 樓層	Unit 單位	Total area of curtain walls of each residential property (sq.m.) 每個住宅物業的幕牆的總面積 (平方米)
Phase 3 Tower 1(1A) 第3期 第1座(1A)	1/F 1樓	A	3.009
		B	2.168
	2/F - 3/F, 5/F - 12/F, 15/F - 23/F, 25/F - 30/F 2樓至3樓、 5樓至12樓、 15樓至23樓、 25樓至30樓	A	3.009
		B	2.288
	31/F - 32/F (Duplex) 31樓至32樓 (複式)	A	5.632
		B	4.798
Phase 3 Tower 1(1B) 第3期 第1座(1B)	1/F 1樓	A	1.007
		B	0.800
		C	0.820
		D	0.820
		E	0.506
		F	0.491
		G	0.801

Tower 座數	Floor 樓層	Unit 單位	Total area of curtain walls of each residential property (sq.m.) 每個住宅物業的幕牆的總面積 (平方米)
Phase 3 Tower 1(1B) 第3期 第1座(1B)	2/F - 3/F, 5/F - 12/F, 15/F - 23/F, 25/F - 30/F 2樓至3樓、 5樓至12樓、 15樓至23樓、 25樓至30樓	A	1.127
		B	0.800
		C	0.820
		D	0.820
		E	0.506
		F	0.491
		G	0.801
	31/F 31樓	A	1.127
		B	0.800
		C	0.820
		D	0.820
		E	0.506
		F	0.491
	32/F 32樓	A	1.127
		B	0.800
		C	0.820
		D	0.820
			E
		F	0.491

Tower 座數	Floor 樓層	Unit 單位	Total area of curtain walls of each residential property (sq.m.) 每個住宅物業的幕牆的總面積 (平方米)
Phase 3 Tower 2 第3期 第2座	1/F 1樓	A	2.024
		B	0.811
		C	0.972
		D	0.767
		E	1.549
	2/F - 3/F, 5/F - 12/F, 15/F - 23/F, 25/F - 30/F 2樓至3樓、 5樓至12樓、 15樓至23樓、 25樓至30樓	A	2.304
		B	0.811
		C	0.972
		D	0.767
		E	1.689
	31/F - 32/F 31樓至32樓	A	2.304
		B	0.811
		C	0.972
		D	0.767
		E	1.689

There will be non-structural prefabricated external walls forming part of the enclosing walls of the Phase.
 期數將會有構成圍封牆的一部份的非結構的預製外牆。

The thickness of the non-structural prefabricated external walls of each block is 150 mm.

每幢建築物的非結構的預製外牆之厚度為150毫米。

Schedule of total area of the non-structural prefabricated external walls of each residential property
每個住宅物業的非結構的預製外牆的總面積表

Tower 座數	Floor 樓層	Unit 單位	Total area of non-structural prefabricated external walls of each residential property (sq.m.) 每個住宅物業的非結構的預製外牆的總面積 (平方米)	
Phase 3 Tower 1(1A) 第3期 第1座(1A)	1/F 1樓	A	-	
		B	0.223	
	2/F - 3/F, 5/F - 12/F, 15/F - 23/F, 25/F - 30/F 2樓至3樓、 5樓至12樓、 15樓至23樓、 25樓至30樓	A	-	
		B	0.223	
		31/F - 32/F (Duplex) 31樓至32樓 (複式)	A	-
			B	0.513
Phase 3 Tower 1(1B) 第3期 第1座(1B)	1/F 1樓	A	1.072	
		B	-	
		C	-	
		D	-	
		E	-	
		F	-	
		G	-	

5

INFORMATION ON DESIGN OF THE PHASE
期數的設計的資料

Tower 座數	Floor 樓層	Unit 單位	Total area of non-structural prefabricated external walls of each residential property (sq.m) 每個住宅物業的非結構的預製外牆的總面積 (平方米)
Phase 3 Tower 1(1B) 第3期 第1座(1B)	2/F - 3/F, 5/F - 12/F, 15/F - 23/F, 25/F - 30/F 2樓至3樓、 5樓至12樓、 15樓至23樓、 25樓至30樓	A	1.072
		B	-
		C	-
		D	-
		E	-
		F	-
		G	-
	31/F 31樓	A	1.072
		B	-
		C	-
		D	-
		E	-
		F	-
	32/F 32樓	A	1.072
		B	-
		C	-
		D	-
		E	-
F		-	

Tower 座數	Floor 樓層	Unit 單位	Total area of non-structural prefabricated external walls of each residential property (sq.m) 每個住宅物業的非結構的預製外牆的總面積 (平方米)
Phase 3 Tower 2 第3期 第2座	1/F 1樓	A	0.427
		B	-
		C	-
		D	-
		E	0.843
	2/F - 3/F, 5/F - 12/F, 15/F - 23/F, 25/F - 30/F 2樓至3樓、 5樓至12樓、 15樓至23樓、 25樓至30樓	A	0.427
		B	-
		C	-
		D	-
		E	0.843
	31/F - 32/F 31樓至32樓	A	0.427
		B	-
		C	-
		D	-
		E	0.843

6

INFORMATION ON PROPERTY MANAGEMENT
物業管理的資料

Person appointed as the Manager of the Phase under the latest draft Deed of Mutual Covenant:
Star Galaxy Limited

根據有關公契的最新擬稿，獲委任為期數的管理人的人：
得倫有限公司

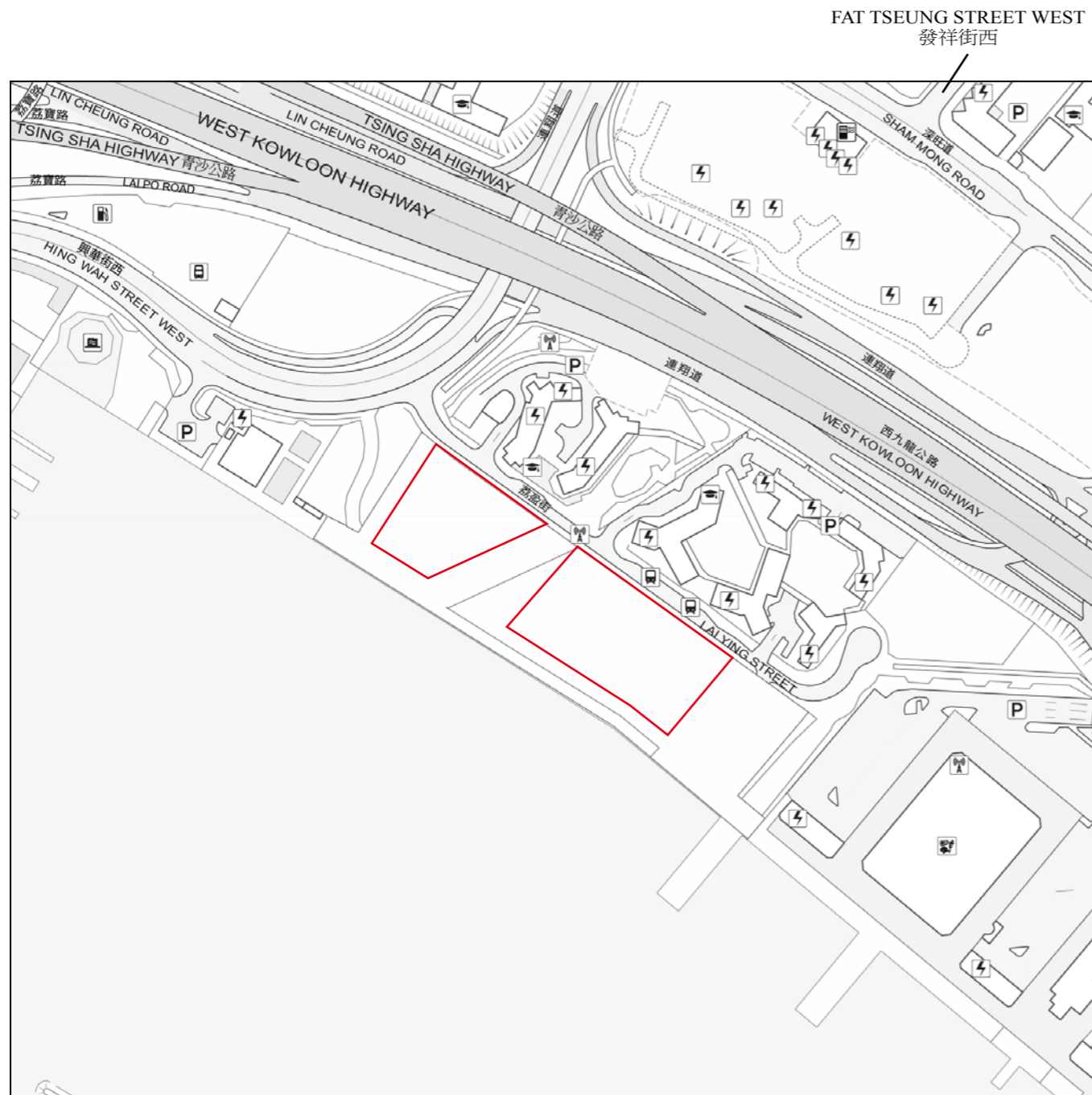

Location of the Development
發展項目的位置

Scale: 比例：0M/米 250M (米)

The location plan is made reference to the Survey Sheet Nos. T11-NW-A dated 13 January 2021 and T11-NW-C dated 20 December 2020 from Survey and Mapping Office of the Lands Department with adjustments where necessary.

此所在位置圖是參考地政總署測繪處於2021年1月13日出版之測繪圖(編號T11-NW-A)及2020年12月20日出版之測繪圖(編號T11-NW-C)編製，有需要處經修正處理。

NOTATION 圖例

Bus Depot 巴士車廠	Public Transport Terminal (including Rail Station) 公共交通總站 (包括鐵路車站)
Ventilation Shaft for the Mass Transit Railway 香港鐵路的通風井	Public Utility Installation 公用事業設施裝置
Sewage Treatment Works and Facilities 污水處理廠及設施	School (including Kindergarten) 學校 (包括幼稚園)
Power Plant (including Electricity Sub-stations) 發電廠(包括電力分站)	Petrol Filling Station 油站
Market (including Wet Market and Wholesale Market) 市場(包括濕貨市場及批發市場)	
Public Carpark (including Lorry Park) 公眾停車場(包括貨車停泊處)	

The maps reproduced with permission of the Director of Lands. © The Government of Hong Kong SAR. Licence No. 120/2020.

地圖版權屬香港特區政府，經地政總署准許複印，版權特許編號120/2020。

Notes:

1. The Vendor advises prospective purchasers to conduct an on-site visit for a better understanding of the Development, its surrounding environment and the public facilities nearby.
2. The location plan may show more area than that is required under the Residential Properties (First-hand Sales) Ordinance due to the technical reason that the boundary of the Development is irregular.

附註：

1. 賣方建議準買家到有關發展項目地盤作實地考察，以對該發展項目、其周邊地區環境及附近的公共設施有較佳了解。
2. 由於發展項目的邊界不規則的技術原因，此所在位置圖所顯示的範圍可能超過《一手住宅物業銷售條例》所規定的範圍。

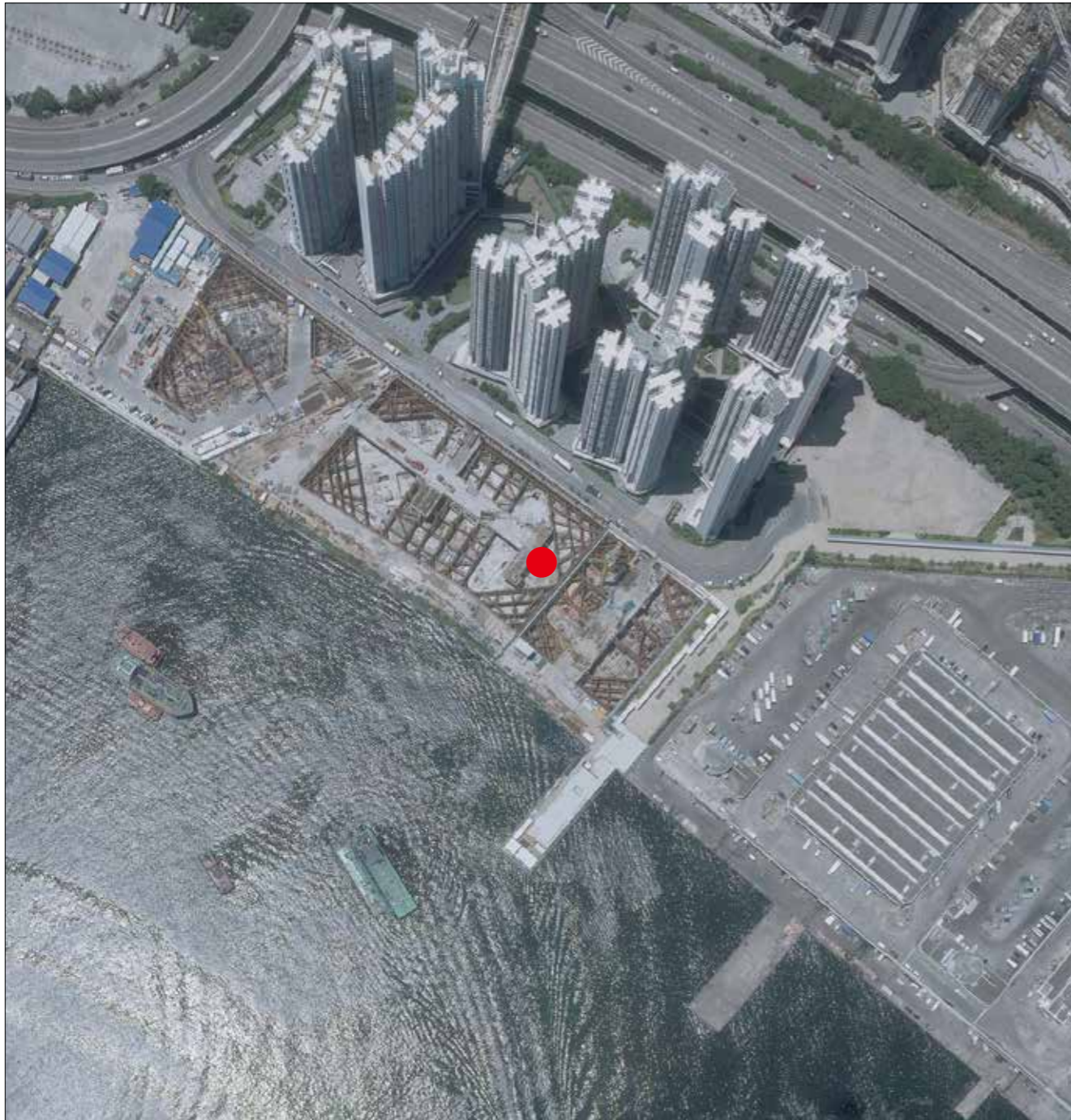

● Location of the Phase
期數的位置



Extracted from part of the aerial photograph taken by the Survey and Mapping Office of the Lands Department at a flying height of 3,000 feet, Photo No. E099370C dated 13 July 2020.

摘錄自地政總署測繪處在3,000呎的飛行高度拍攝之鳥瞰照片，照片編號E099370C，飛行日期為2020年7月13日。

Survey and Mapping Office, Lands Department, The Government of HKSAR © Copyright reserved - reproduction by permission only.

香港特別行政區政府地政總署測繪處©版權所有，未經許可，不得複製。

Notes :

1. Copy of the aerial photograph of the Phase is available for free inspection at the sales office of the Phase during opening hours.
2. The aerial photograph may show more area than that is required under the Residential Properties (First-hand Sales) Ordinance due to technical reason that the boundary of the Phase is irregular.
3. The Vendor advises prospective purchasers to conduct on-site visit for a better understanding of the Phase, its surrounding environment and the public facilities nearby.

附註：

1. 期數的鳥瞰照片之副本可於期數的售樓處開放時間內免費查閱。
2. 由於期數的邊界不規則的技術原因，此鳥瞰照片所顯示的範圍可能超過《一手住宅物業銷售條例》所規定的範圍。
3. 賣方建議準買家到有關期數地盤作實地考察，以對該期數、其周邊地區環境及附近的公共設施有較佳了解。

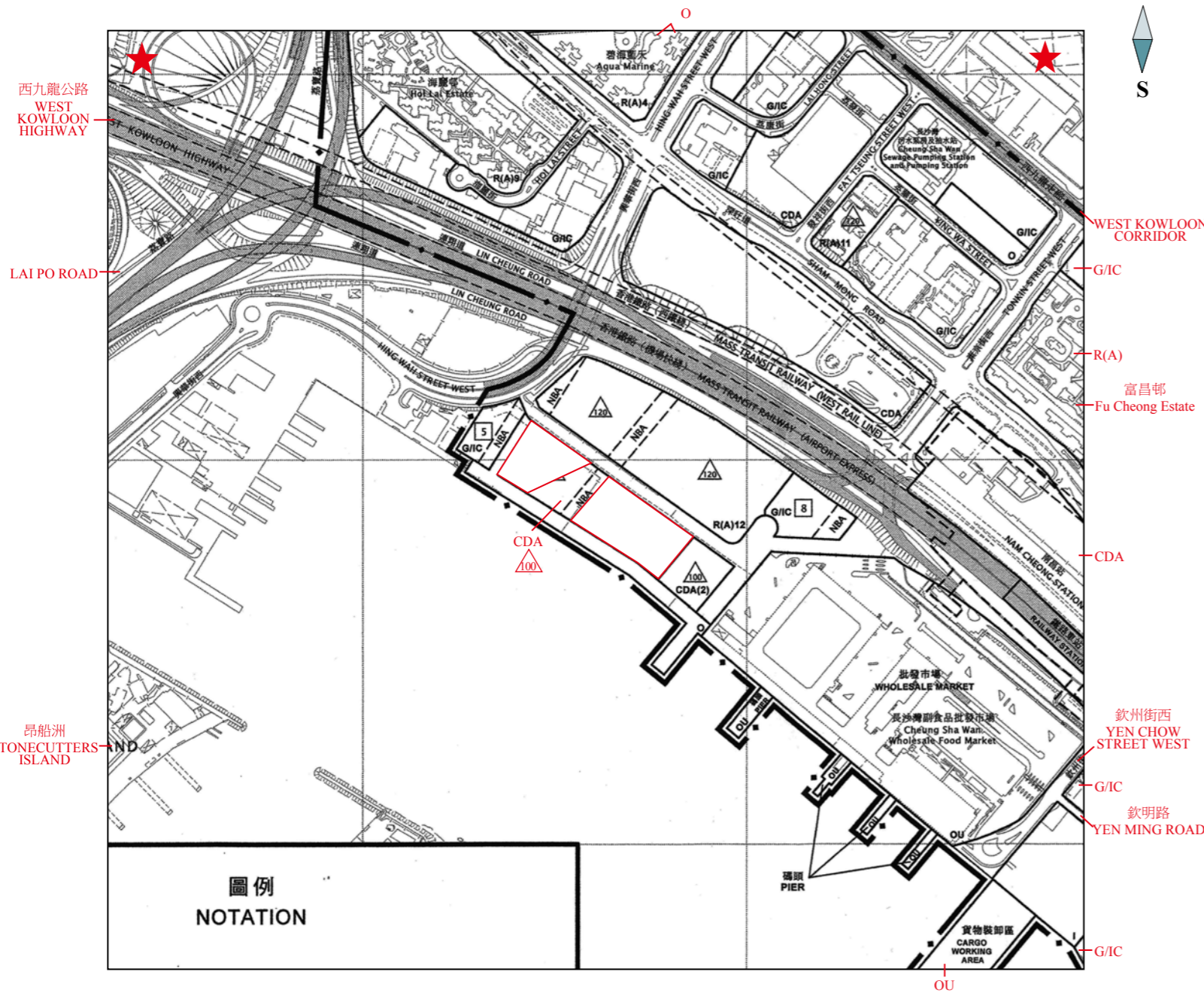

圖例
NOTATION

- Boundary of the Development
發展項目的界線
- ★ This area is covered by other outline zoning plan but falls outside 500 metres from the boundary of the Development.
此區域被其他分區計劃大綱圖所覆蓋但超出發展項目的界線500米之外。

- Notes :
- The last updated outline zoning plan and the attached schedule as at the date of printing of the sales brochure is available for free inspection at the sales office of the Phase during opening hours.
 - The Vendor also advises prospective purchasers to conduct an on-site visit for a better understanding of the Development, its surrounding environment and the public facilities nearby.
 - The outline zoning plan may show more area than that is required under the Residential Properties (First-hand Sales) Ordinance due to technical reason that the boundary of the Development is irregular.

Extracted from Approved South West Kowloon Outline Zoning Plan No. S/K20/30, gazetted on 3 October 2014 with adjustments where necessary as shown in red. The plan, prepared by the Planning Department under the direction of the Town Planning Board, is reproduced with the permission of the Director of Lands. © The Government of Hong Kong SAR.

摘錄自2014年10月3日刊憲之西南九龍分區計劃大綱核准圖，圖則編號為S/K20/30，有需要處經修正處理，以紅色顯示。地圖為規劃署遵照城市規劃委員會指示擬備，版權屬香港特別行政區政府，經地政總署准許複印。

NOTATION 圖例

ZONES	地帶
COMPREHENSIVE DEVELOPMENT AREA	CDA 綜合發展區
RESIDENTIAL (GROUP A)	R(A) 住宅 (甲類)
INDUSTRIAL	I 工業
GOVERNMENT, INSTITUTION OR COMMUNITY	G/IC 政府、機構或社區
OPEN SPACE	O 休憩用地
OTHER SPECIFIED USES	OU 其他指定用途
COMMUNICATIONS	交通
RAILWAY AND STATION	 鐵路及車站
RAILWAY AND STATION (UNDERGROUND)	 鐵路及車站(地下)
MAJOR ROAD AND JUNCTION	 主要道路及路口
ELEVATED ROAD	 高架道路
MISCELLANEOUS	其他
BOUNDARY OF PLANNING SCHEME	 規劃範圍界線
MAXIMUM BUILDING HEIGHT (IN METRES ABOVE PRINCIPAL DATUM)	100 最高建築物高度 (在主水平基準上若干米)
MAXIMUM BUILDING HEIGHT (IN NUMBER OF Store RoomYS)	5 最高建築物高度 (樓層數目)
NON-BUILDING AREA	NBA 非建築用地

- 附註：
- 在印刷售樓說明書當日所適用的最近期分區計劃大綱圖及其附表，可於期數的售樓處開放時間內免費查閱。
 - 賣方亦建議準買家到有關發展項目作實地考察，以對該發展項目、其周邊地區環境及附近的公共設施有較佳了解。
 - 由於發展項目的邊界不規則的技術原因，此分區計劃大綱圖所顯示的範圍可能超過《一手住宅物業銷售條例》所規定的範圍。

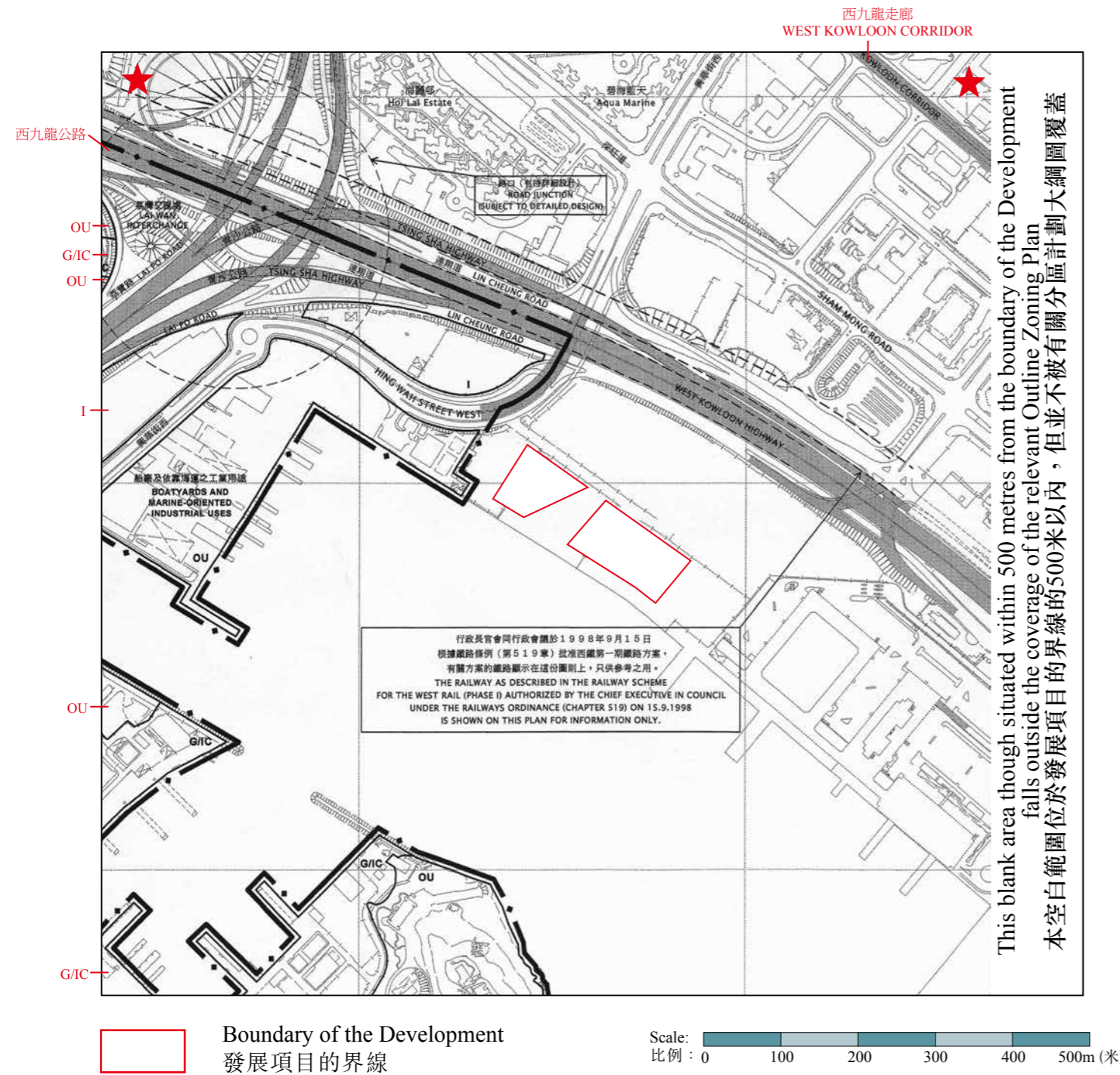

Extracted from Approved Stonecutters Island Outline Zoning Plan No. S/SC/10, gazetted on 23 September 2011 with adjustments where necessary as shown in red. The plan, prepared by the Planning Department under the direction of the Town Planning Board, is reproduced with the permission of the Director of Lands. © The Government of Hong Kong SAR.

摘錄自2011年9月23日刊憲之昂船洲分區計劃大綱核准圖，圖則編號為S/SC/10，有需要處經修正處理，以紅色顯示。地圖為規劃署遵照城市規劃委員會指示擬備，版權屬香港特別行政區政府，經地政總署准許複印。

NOTATION 圖例

ZONES

- INDUSTRIAL
- GOVERNMENT, INSTITUTION OR COMMUNITY
- OTHER SPECIFIED USES

- 地帶
- I 工業
 - G/IC 政府、機構或社區
 - OU 其他指定用途

COMMUNICATIONS

- RAILWAY AND STATION (UNDERGROUND)
- MAJOR ROAD AND JUNCTION
- ELEVATED ROAD

- 交通
- 鐵路及車站(地下)
 - 主要道路及路口
 - 高架道路

MISCELLANEOUS

- BOUNDARY OF PLANNING SCHEME

- 其他
- 規劃範圍界線

Boundary of the Development
 發展項目的界線

Scale: 比例: 0 100 200 300 400 500m (米)

★ This area is covered by other outline zoning plan but falls outside 500 metres from the boundary of the Development.
 此區域被其他分區計劃大綱圖所覆蓋但超出發展項目的界線500米之外。

Notes :

1. The last updated outline zoning plan and the attached schedule as at the date of printing of the sales brochure is available for free inspection at the sales office of the Phase during opening hours.
2. The Vendor also advises prospective purchasers to conduct an on-site visit for a better understanding of the Development, its surrounding environment and the public facilities nearby.
3. The outline zoning plan may show more area than that is required under the Residential Properties (First-hand Sales) Ordinance due to technical reason that the boundary of the Development is irregular.

附註：

1. 在印刷售樓說明書當日所適用的最近期分區計劃大綱圖及其附表，可於期數的售樓處開放時間內免費查閱。
2. 賣方亦建議準買家到有關發展項目作實地考察，以對該發展項目、其周邊地區環境及附近的公共設施有較佳了解。
3. 由於發展項目的邊界不規則的技術原因，此分區計劃大綱圖所顯示的範圍可能超過《一手住宅物業銷售條例》所規定的範圍。

11 FLOOR PLANS OF RESIDENTIAL PROPERTIES IN THE PHASE

期數的住宅物業的樓面平面圖

Legend 圖例

A/C PLATFORM	= 空調機平台 AIR CONDITIONER PLATFORM
A.D.	= 排風管 AIR DUCT
ARCH. FEATURE	= 建築裝飾 ARCHITECTURAL FEATURE
BAL.	= 露台 BALCONY
BATH	= 浴室 BATHROOM
B.R.	= 睡房 BEDROOM
DIN.	= 飯廳 DINING ROOM
DN	= 落 DOWN
E.M.C.	= 電錶櫃 ELECTRICAL METER CABINET
E.M.R.	= 電錶房 ELECTRICAL METER ROOM
E.L.V.	= 特低壓電線房 EXTRA-LOW VOLTAGE CABLE ROOM
E.L. DUCT	= 電線槽 ELECTRICAL DUCT
H.R.	= 消防喉轆 HOSE REEL
KIT.	= 廚房 KITCHEN
LAV.	= 衛生間 LAVATORY
LIV.	= 客廳 LIVING ROOM
M.B.R.	= 主人睡房 MASTER BEDROOM
M. BATH	= 主人浴室 MASTER BATHROOM
M. ENSUITE	= 主人套房 MASTER ENSUITE
OPEN KIT.	= 開放式廚房 OPEN KITCHEN

P.D.	= 管道 PIPE DUCT
REST RM.	= 洗手間 REST ROOM
RS / MRR	= 垃圾及物料回收室 REFUSE STORAGE AND MATERIAL RECOVERY ROOM
STORE	= 儲物房 STORE
UP	= 上 UP
U.P.	= 工作平台 UTILITY PLATFORM
UTIL.	= 多功能房 UTILITY ROOM
W.M.C.	= 水錶櫃 WATER METER CABINET
W.M.R.	= 水錶房 WATER METER ROOM
(F)	= 噪音緩解措施 (隔聲簷) NOISE MITIGATION MEASURE (FIN)
(FG)	= 噪音緩解措施 (固定玻璃) NOISE MITIGATION MEASURE (FIXED GLAZING)
(MW)	= 噪音緩解措施 (維修窗) NOISE MITIGATION MEASURE (MAINTENANCE WINDOW)
(SC)	= 噪音緩解措施 (自動關閉門) NOISE MITIGATION MEASURE (SELF-CLOSING DOOR)
(SW)	= 噪音緩解措施 (實牆) NOISE MITIGATION MEASURE (SOLID WALL)
[A/C] / [A/C x2]	= 空調機(室外機)位置 LOCATION OF AIR CONDITIONER (OUTDOOR UNIT)
(BT)	= 浴缸 BATH TUB
(S)	= 淋浴間 SHOWER CUBICLE

Notes:

- There may be architectural features and/or exposed pipes on external walls of some floors.
- Common pipes exposed and/ or enclosed in cladding are located at/ adjacent to balcony and/ or flat roof and/ or roof and/ or utility platform and/ or air-conditioner platform and/ or external wall of some units.
- There are ceiling bulkheads or false ceiling at living room, dining room, bedroom, ensuite, bathroom, rest room, lavatory, utility room, store, open kitchen and kitchen of some units for the air-conditioning system and/ or mechanical and electrical services. There are sunken slabs for mechanical & electrical services of units above at some residential units.
- The internal ceiling height within some units may vary due to structural, architectural and/ or decoration design variations.
- Symbols of fittings and fitments shown on the floor plans, such as doors, bath tubs, basins, water closets, basin cabinets, sinks etc, are retrieved from the latest approved building plans and only for general indication of their approximate location, but not indications of their actual size, design, shape and quantity.
- For some residential units, the air-conditioner platform(s) outside the residential unit will be placed with 1 or more than 1 air-conditioner (Outdoor Unit). These air-conditioners may generate heat and/ or sound.
- Balconies and utility platforms are non-enclosed areas.
- During the necessary maintenance of the external walls by manager of the Phase, the gondola will be operating in the airspace outside window of residential properties and above flat roof and roof in such tower.

附註:

- 部份樓層外牆設有建築裝飾及/或外露喉管。
- 部份單位的露台及/或平台及/或天台及/或工作平台及/或空調機平台及/或外牆或其鄰近地方設有外露及/或內藏於飾板的公用喉管。
- 部份單位客廳、飯廳、睡房、套房、浴室、洗手間、衛生間、多功能房、儲物房、開放式廚房及廚房有裝飾橫樑或假天花，用以裝置冷氣系統及/或機電設備。部分單位天花有跌級樓板，用以安裝樓上單位之機電設備。
- 部份單位之天花高度將會因應結構、建築及/或裝修設計上的需要而有差異。
- 樓面平面圖上所顯示的形象裝置符號，例如門、浴缸、洗面盆、坐廁、洗面盆櫃、洗滌盆等乃根據最新的經批准的建築圖則，只作一般性標誌以顯示其大約位置，而非展示其實際大小、設計、形狀及數量。
- 部份住宅單位外的空調機平台將會放置一部或多部空調機(室外機)。該等空調機可能發出熱力及/或聲音。
- 露台及工作平台為不可封閉的地方。
- 在期數管理人員安排外牆之必要維修進行期間，吊船將在該等大廈的住宅物業之窗戶外及平台及天台上之空間運作。

Phase 3 Tower 1(1A) 1/F Floor Plan
第3期 第1座(1A) 1樓樓面平面圖

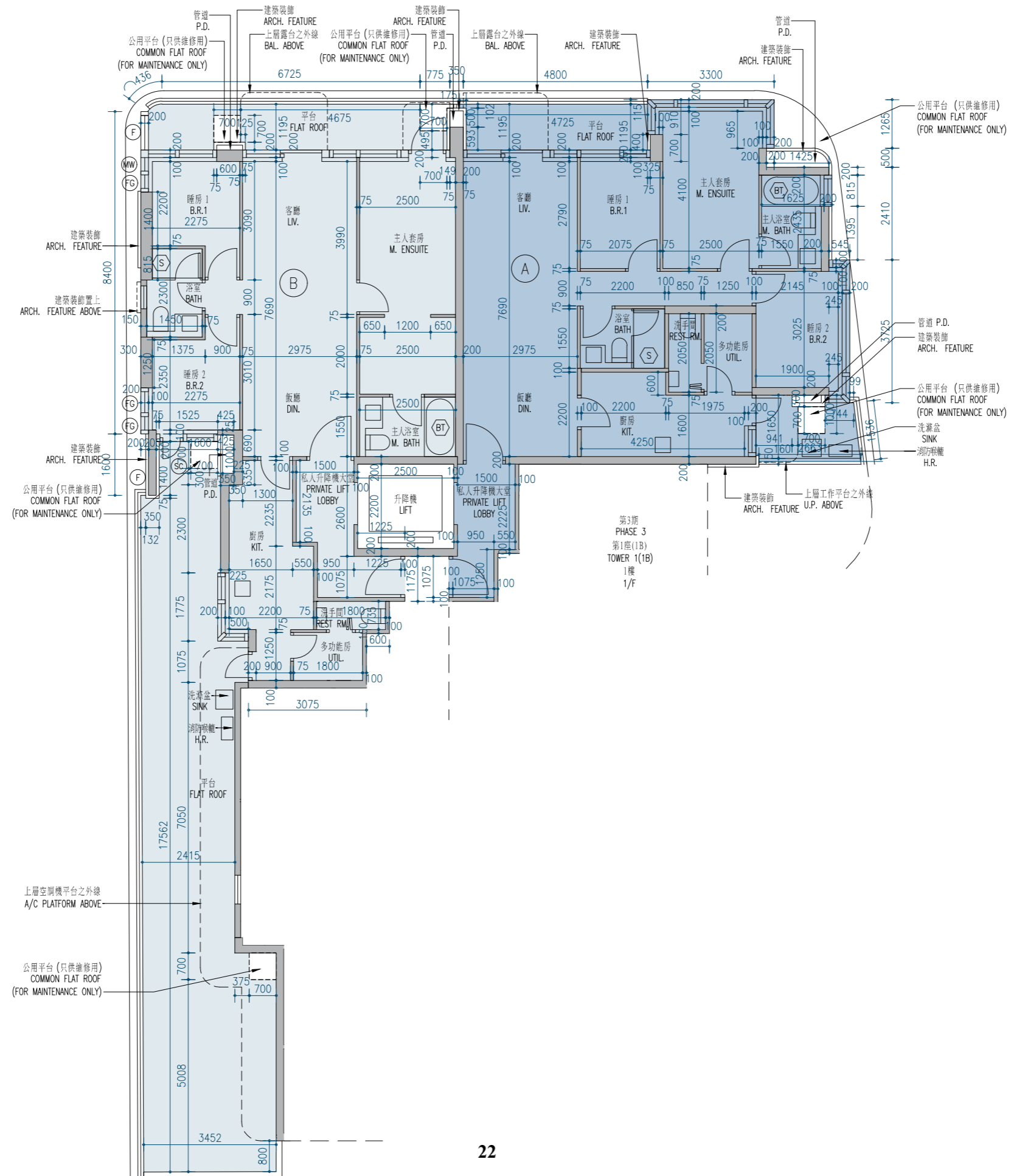

	Tower 座數	Floor 樓層	Units 單位	
			A	B
The thickness of the floor slabs (excluding plaster) of each residential property (mm) 每個住宅物業的樓板(不包括灰泥)的厚度(毫米)	Phase 3 Tower 1(1A) 第3期 第1座(1A)	1/F 1樓	150, 300	150, 300
The floor-to-floor height (i.e. the height between the top surface of the structural slab of a floor and the top surface of the structural slab of its immediate upper floor) of each residential property (mm) 每個住宅物業的層與層之間的高度(指該樓層之石屎地台面與上一層石屎地台面之高度距離)(毫米)			2700, 2750, 2800, 3100	2700, 2750, 2800, 3100

The internal areas of the residential properties on the upper floors will generally be slightly larger than those on the lower floors because of the reducing thickness of the structural walls on the upper floors. (Note: This statement required in Section 10(2)(e) in Part 1 of Schedule 1 of the Residential Properties (First-hand Sales) Ordinance (Cap.621) is not applicable to the Phase).

Notes:

- The dimensions in the floor plans are all structural dimensions in millimetre.
- Please refer to page 21 of this sales brochure for legend of the terms and abbreviations in studying the floor plans.

因住宅物業的較高樓層的結構牆的厚度遞減，較高樓層的內部面積，一般比較低樓層的內部面積稍大。(註：此根據《一手住宅物業銷售條例》(第621章)附表1第1部第10(2)(e)條所規定的陳述並不適用於期數)

附註：

- 樓面平面圖之尺規所列數字為以毫米標示之建築結構尺寸。
- 請參閱本售樓說明書第21頁之圖例以協助閱讀樓面平面圖之名稱和簡稱。

11 FLOOR PLANS OF RESIDENTIAL PROPERTIES IN THE PHASE 期數的住宅物業的樓面平面圖

Phase 3 Tower 1(1A) 2/F-3/F, 5/F-12/F, 15/F-23/F, 25/F-30/F Floor Plan
第3期 第1座(1A) 2樓至3樓、5樓至12樓、15樓至23樓、25樓至30樓樓面平面圖

Scale:  5M (米)
比例: 0M/米

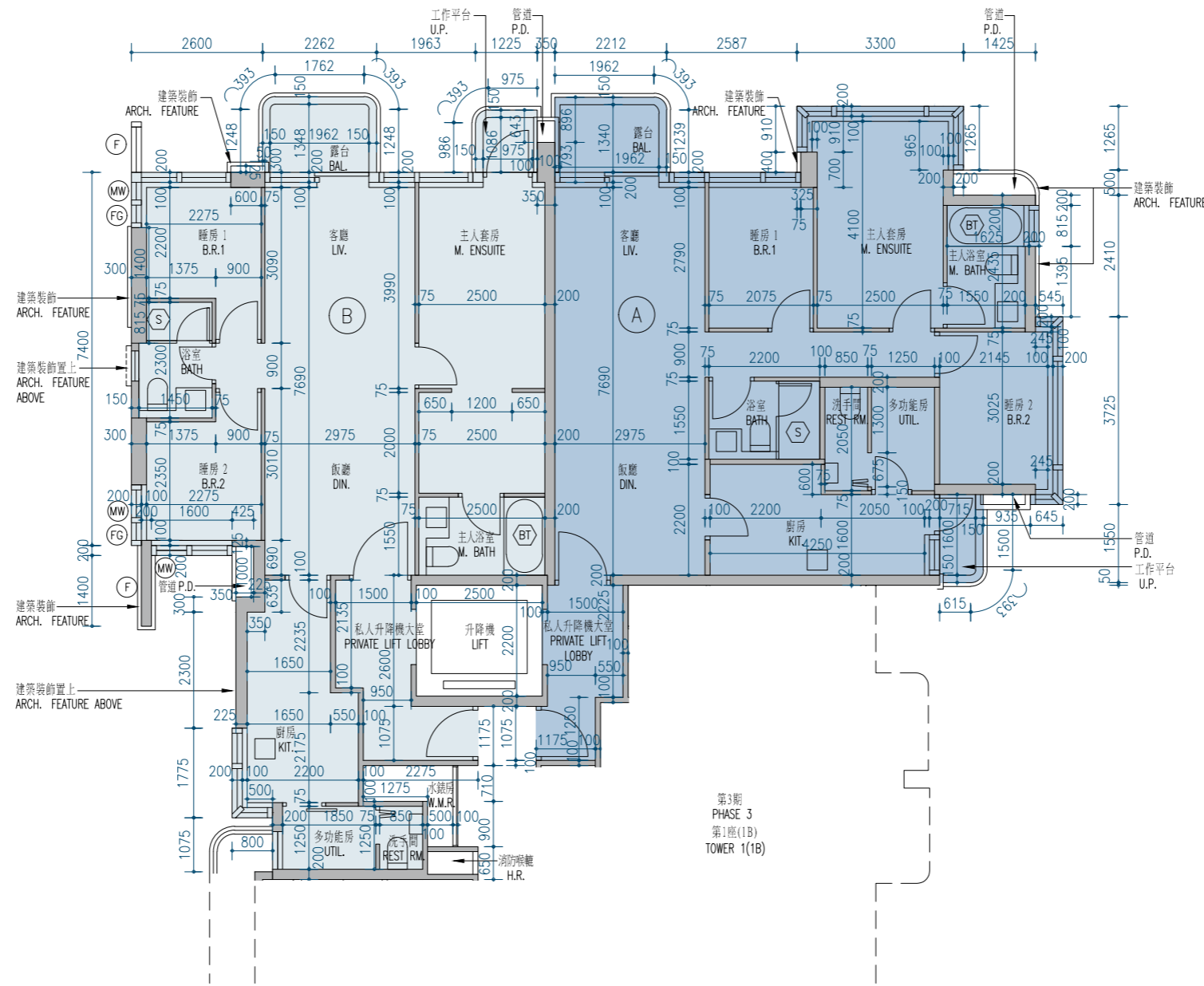

第3期
PHASE 3
第1座(1A)
TOWER 1(1A)

	Tower 座數	Floor 樓層	Units 單位	
			A	B
The thickness of the floor slabs (excluding plaster) of each residential property (mm) 每個住宅物業的樓板(不包括灰泥)的厚度(毫米)	Phase 3 Tower 1(1A) 第3期 第1座(1A)	2/F - 3/F, 5/F - 12/F, 15/F - 23/F, 25/F-29/F 2樓至3樓、 5樓至12樓、 15樓至23樓、 25樓至29樓	150, 300	150, 300
The floor-to-floor height (i.e. the height between the top surface of the structural slab of a floor and the top surface of the structural slab of its immediate upper floor) of each residential property (mm) 每個住宅物業的層與層之間的高度(指該樓層之石屎地台面與上一層石屎地台面之高度距離)(毫米)		2700, 2750, 2800, 3100	2700, 2750, 2800, 3100	
The thickness of the floor slabs (excluding plaster) of each residential property (mm) 每個住宅物業的樓板(不包括灰泥)的厚度(毫米)		30/F 30樓	150, 200, 300	150, 200, 300
The floor-to-floor height (i.e. the height between the top surface of the structural slab of a floor and the top surface of the structural slab of its immediate upper floor) of each residential property (mm) 每個住宅物業的層與層之間的高度(指該樓層之石屎地台面與上一層石屎地台面之高度距離)(毫米)		3150, 3200, 3250, 3500	3150, 3200, 3250, 3500	

The internal areas of the residential properties on the upper floors will generally be slightly larger than those on the lower floors because of the reducing thickness of the structural walls on the upper floors. (Note: This statement required in Section 10(2)(e) in Part 1 of Schedule 1 of the Residential Properties (First-hand Sales) Ordinance (Cap.621) is not applicable to the Phase).

Notes:

- The dimensions in the floor plans are all structural dimensions in millimetre.
- Please refer to page 21 of this sales brochure for legend of the terms and abbreviations in studying the floor plans.

因住宅物業的較高樓層的結構牆的厚度遞減，較高樓層的內部面積，一般比較低樓層的內部面積稍大。(註：此根據《一手住宅物業銷售條例》(第621章)附表1第1部第10(2)(e)條所規定的陳述並不適用於期數)

附註：

- 樓面平面圖之尺規所列數字為以毫米標示之建築結構尺寸。
- 請參閱本售樓說明書第21頁之圖例以協助閱讀樓面平面圖之名稱和簡稱。

Phase 3 Tower 1(1A) 31/F Floor Plan
第3期 第1座(1A) 31樓樓面平面圖

Scale:  5M (米)
比例: 0M/米

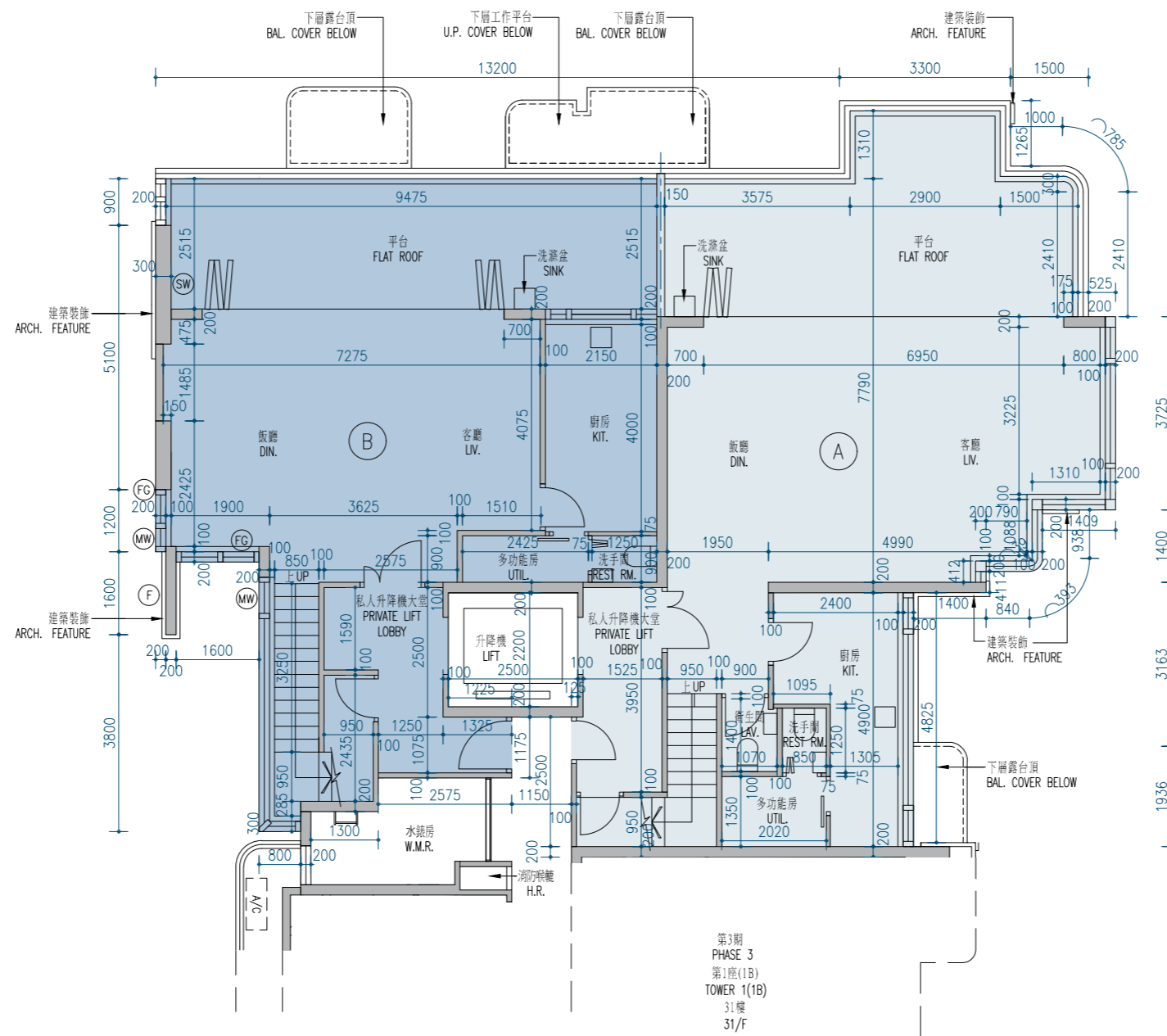

	Tower 座數	Floor 樓層	Units 單位	
			A	B
The thickness of the floor slabs (excluding plaster) of each residential property (mm) 每個住宅物業的樓板(不包括灰泥)的厚度(毫米)	Phase 3 Tower 1(1A) 第3期 第1座(1A)	31/F 31樓	150, 300	150, 300
The floor-to-floor height (i.e. the height between the top surface of the structural slab of a floor and the top surface of the structural slab of its immediate upper floor) of each residential property (mm) 每個住宅物業的層與層之間的高度(指該樓層之石屎地台面與上一層石屎地台面之高度距離)(毫米)			3200, 3300, 3500	3200, 3300, 3500

The internal areas of the residential properties on the upper floors will generally be slightly larger than those on the lower floors because of the reducing thickness of the structural walls on the upper floors. (Note: This statement required in Section 10(2)(e) in Part 1 of Schedule 1 of the Residential Properties (First-hand Sales) Ordinance (Cap.621) is not applicable to the Phase).

Notes:

- The dimensions in the floor plans are all structural dimensions in millimetre.
- Please refer to page 21 of this sales brochure for legend of the terms and abbreviations in studying the floor plans.

因住宅物業的較高樓層的結構牆的厚度遞減，較高樓層的內部面積，一般比較低樓層的內部面積稍大。(註：此根據《一手住宅物業銷售條例》(第621章)附表1第1部第10(2)(e)條所規定的陳述並不適用於期數)

附註：

- 樓面平面圖之尺規所列數字為以毫米標示之建築結構尺寸。
- 請參閱本售樓說明書第21頁之圖例以協助閱讀樓面平面圖之名稱和簡稱。

11 FLOOR PLANS OF RESIDENTIAL PROPERTIES IN THE PHASE 3 期數的住宅物業的樓面平面圖

Phase 3 Tower 1(1A) 32/F Floor Plan
第3期 第1座(1A) 32樓樓面平面圖

Scale:  5M (米)
比例: 0M/米

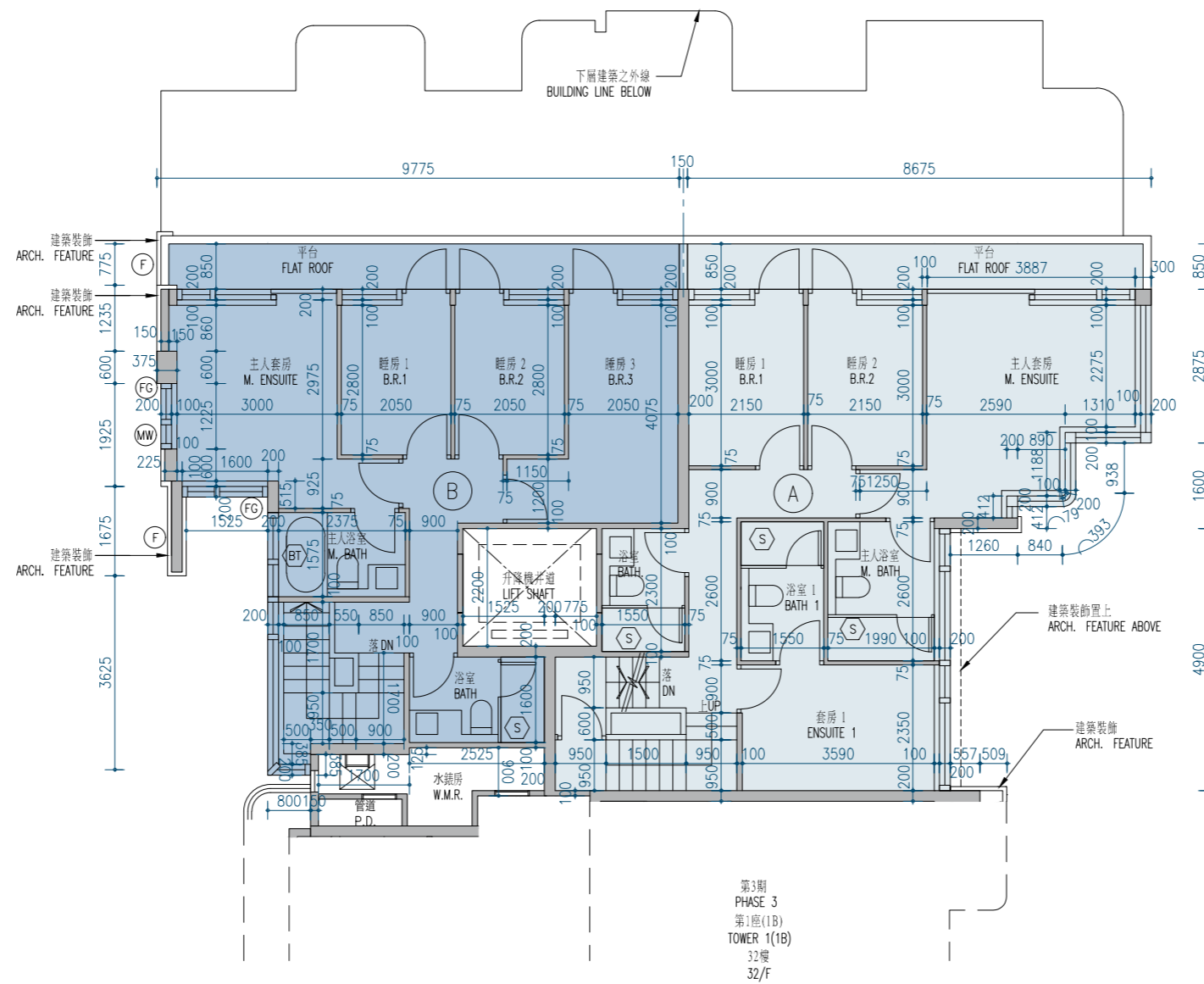

	Tower 座數	Floor 樓層	Units 單位	
			A	B
The thickness of the floor slabs (excluding plaster) of each residential property (mm) 每個住宅物業的樓板(不包括灰泥)的厚度(毫米)	Phase 3 Tower 1(1A) 第3期 第1座(1A)	32/F 32樓	150, 200, 300	150, 300
The floor-to-floor height (i.e. the height between the top surface of the structural slab of a floor and the top surface of the structural slab of its immediate upper floor) of each residential property (mm) 每個住宅物業的層與層之間的高度(指該樓層之石屎地台面與上一層石屎地台面之高度距離)(毫米)			3350, 3750	3350

The internal areas of the residential properties on the upper floors will generally be slightly larger than those on the lower floors because of the reducing thickness of the structural walls on the upper floors. (Note: This statement required in Section 10(2)(e) in Part 1 of Schedule 1 of the Residential Properties (First-hand Sales) Ordinance (Cap.621) is not applicable to the Phase).

Notes:

1. The dimensions in the floor plans are all structural dimensions in millimetre.
2. Please refer to page 21 of this sales brochure for legend of the terms and abbreviations in studying the floor plans.

因住宅物業的較高樓層的結構牆的厚度遞減，較高樓層的內部面積，一般比較低樓層的內部面積稍大。(註：此根據《一手住宅物業銷售條例》(第621章)附表1第1部第10(2)(e)條所規定的陳述並不適用於期數)

附註：

1. 樓面平面圖之尺規所列數字為以毫米標示之建築結構尺寸。
2. 請參閱本售樓說明書第21頁之圖例以協助閱讀樓面平面圖之名稱和簡稱。

Phase 3 Tower 1(1A) Roof Plan
第3期 第1座(1A) 天台平面圖

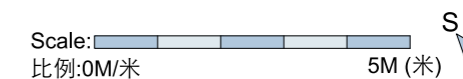
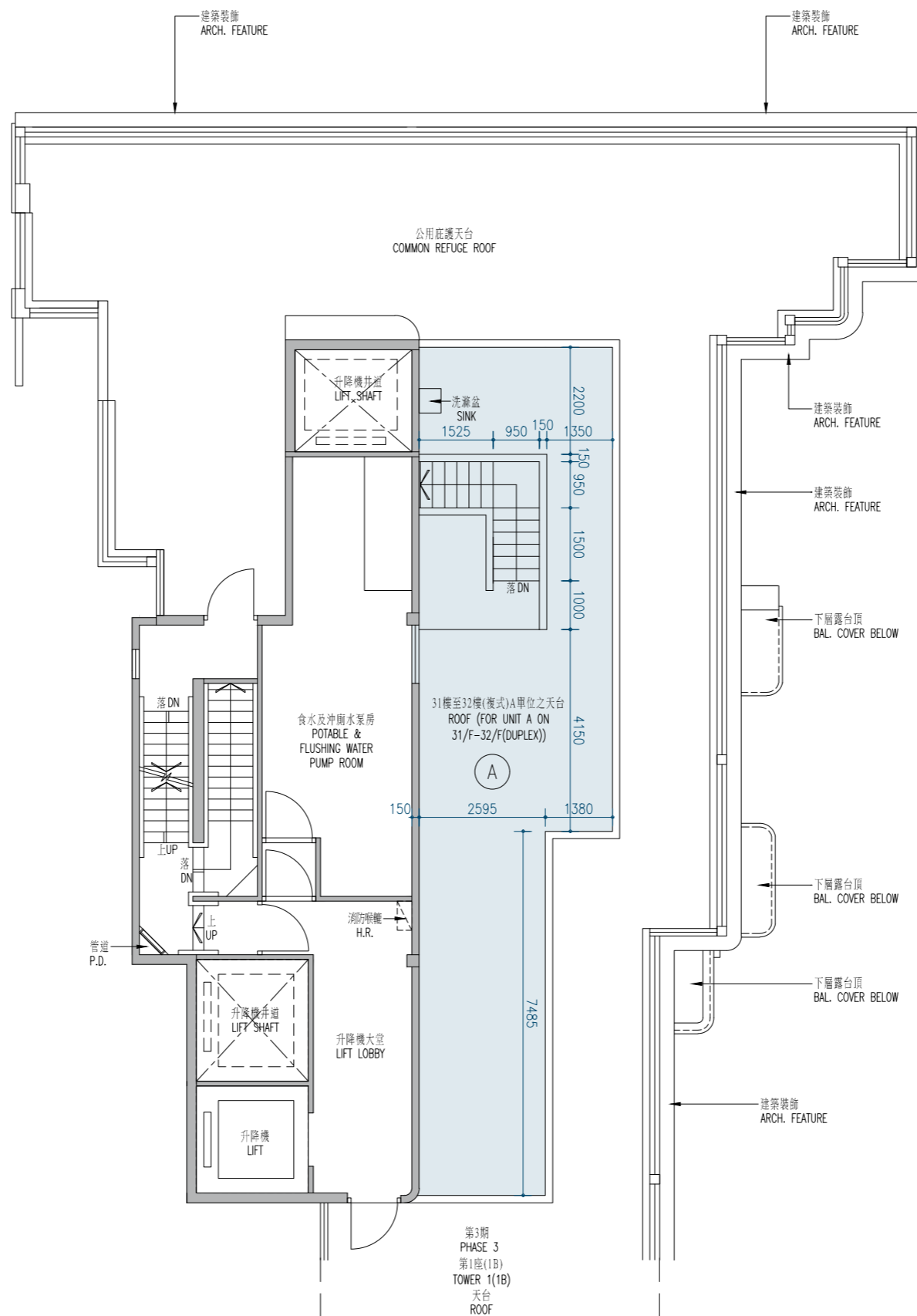

	Tower 座數	Floor 樓層	Units 單位
			A
The thickness of the floor slabs (excluding plaster) of each residential property (mm) 每個住宅物業的樓板(不包括灰泥)的厚度(毫米)	Phase 3 Tower 1(1A) 第3期 第1座(1A)	Roof 天台	Not Applicable 不適用
The floor-to-floor height (i.e. the height between the top surface of the structural slab of a floor and the top surface of the structural slab of its immediate upper floor) of each residential property (mm) 每個住宅物業的層與層之間的高度(指該樓層之石屎地台面與上一層石屎地台面之高度距離)(毫米)			

The internal areas of the residential properties on the upper floors will generally be slightly larger than those on the lower floors because of the reducing thickness of the structural walls on the upper floors. (Note: This statement required in Section 10(2)(e) in Part 1 of Schedule 1 of the Residential Properties (First-hand Sales) Ordinance (Cap.621) is not applicable to the Phase).

Notes:

- The dimensions in the floor plans are all structural dimensions in millimetre.
- Please refer to page 21 of this sales brochure for legend of the terms and abbreviations in studying the floor plans.

因住宅物業的較高樓層的結構牆的厚度遞減，較高樓層的內部面積，一般比較低樓層的內部面積稍大。(註：此根據《一手住宅物業銷售條例》(第621章)附表1第1部第10(2)(e)條所規定的陳述並不適用於期數)

附註：

- 樓面平面圖之尺規所列數字為以毫米標示之建築結構尺寸。
- 請參閱本售樓說明書第21頁之圖例以協助閱讀樓面平面圖之名稱和簡稱。

11 FLOOR PLANS OF RESIDENTIAL PROPERTIES IN THE PHASE 3 期數的住宅物業的樓面平面圖

Phase 3 Tower 1(1B) 1/F Floor Plan
第3期 第1座(1B) 1樓樓面平面圖

Scale: 0M/米 5M(米) S

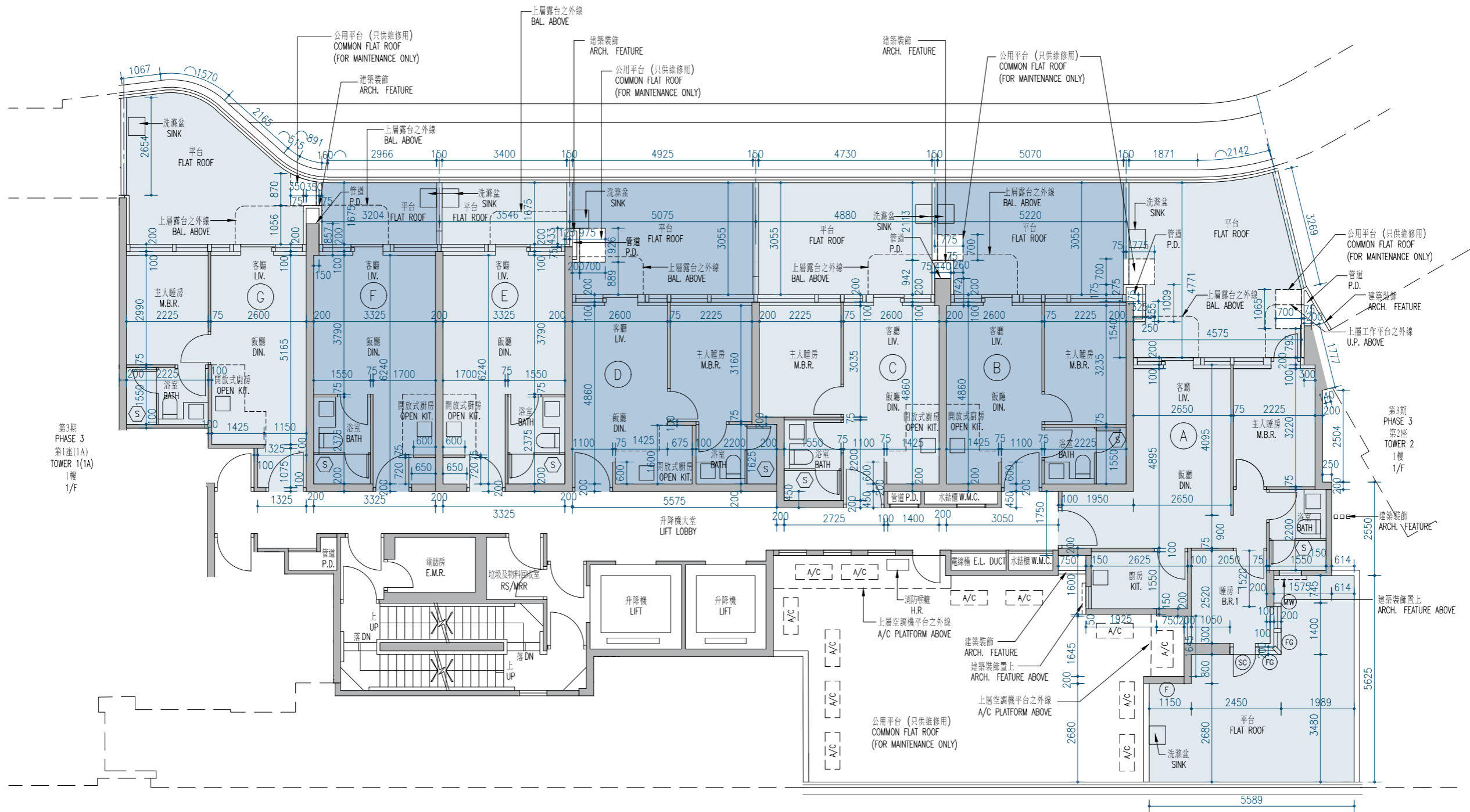

	Tower 座數	Floor 樓層	Units 單位						
			A	B	C	D	E	F	G
The thickness of the floor slabs (excluding plaster) of each residential property (mm) 每個住宅物業的樓板(不包括灰泥)的厚度(毫米)	Phase 3 Tower 1(1B) 第3期 第1座(1B)	1/F 1樓	150, 300	150, 300	150, 300	150, 300	150, 300	150, 300	150, 300
The floor-to-floor height (i.e. the height between the top surface of the structural slab of a floor and the top surface of the structural slab of its immediate upper floor) of each residential property (mm) 每個住宅物業的層與層之間的高度(指該樓層之石屎地台面與上一層石屎地台面之高度距離)(毫米)			2800, 3100	2800, 3100	2800, 3100	2800, 3100	2800, 3100	2800, 3100	2800, 3100

The internal areas of the residential properties on the upper floors will generally be slightly larger than those on the lower floors because of the reducing thickness of the structural walls on the upper floors. (Note: This statement required in Section 10(2)(e) in Part 1 of Schedule 1 of the Residential Properties (First-hand Sales) Ordinance (Cap.621) is not applicable to the Phase).

Notes:

- The dimensions in the floor plans are all structural dimensions in millimetre.
- Please refer to page 21 of this sales brochure for legend of the terms and abbreviations in studying the floor plans.

因住宅物業的較高樓層的結構牆的厚度遞減，較高樓層的內部面積，一般比較低樓層的內部面積稍大。(註：此根據《一手住宅物業銷售條例》(第621章)附表1第1部第10(2)(e)條所規定的陳述並不適用於期數)

附註：

- 樓面平面圖之尺規所列數字為以毫米標示之建築結構尺寸。
- 請參閱本售樓說明書第21頁之圖例以協助閱讀樓面平面圖之名稱和簡稱。

11 FLOOR PLANS OF RESIDENTIAL PROPERTIES IN THE PHASE 期數的住宅物業的樓面平面圖

Phase 3 Tower 1(1B) 2/F-3/F, 5/F-12/F, 15/F-23/F, 25/F-30/F Floor Plan
第3期 第1座(1B) 2樓至3樓、5樓至12樓、15樓至23樓、25樓至30樓樓面平面圖

Scale: 0M/米 5M(米) S

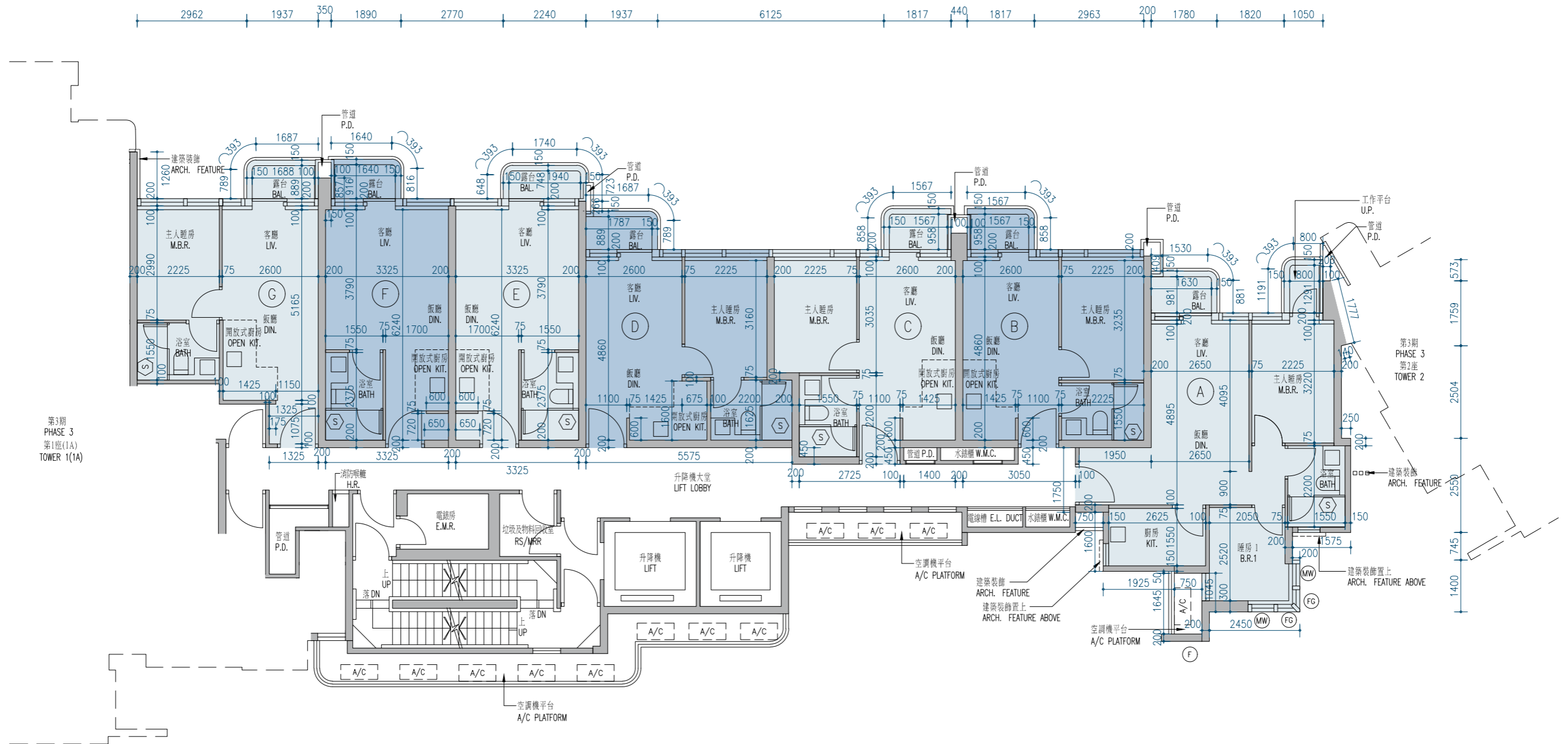

	Tower 座數	Floor 樓層	Units 單位						
			A	B	C	D	E	F	G
The thickness of the floor slabs (excluding plaster) of each residential property (mm) 每個住宅物業的樓板(不包括灰泥)的厚度(毫米)	Phase 3 Tower 1(1B) 第3期 第1座(1B)	2/F - 3/F, 5/F - 12/F, 15/F - 23/F, 25/F-29/F 2樓至3樓、 5樓至12樓、 15樓至23樓、 25樓至29樓	150, 300	150, 300	150, 300	150, 300	150, 300	150, 300	150, 300
The floor-to-floor height (i.e. the height between the top surface of the structural slab of a floor and the top surface of the structural slab of its immediate upper floor) of each residential property (mm) 每個住宅物業的層與層之間的高度(指該樓層之石屎地台面與上一層石屎地台面之高度距離)(毫米)		2800, 3100	2800, 3100	2800, 3100	2800, 3100	2800, 3100	2800, 3100	2750, 2800, 3100	
The thickness of the floor slabs (excluding plaster) of each residential property (mm) 每個住宅物業的樓板(不包括灰泥)的厚度(毫米)		30/F 30樓	150, 300	150, 300	150, 300	150, 300	150, 300	150, 300	150, 300
The floor-to-floor height (i.e. the height between the top surface of the structural slab of a floor and the top surface of the structural slab of its immediate upper floor) of each residential property (mm) 每個住宅物業的層與層之間的高度(指該樓層之石屎地台面與上一層石屎地台面之高度距離)(毫米)		3200, 3500	3200, 3500	3200, 3500	3200, 3500	3200, 3500	3200, 3500	3150, 3200, 3500	

The internal areas of the residential properties on the upper floors will generally be slightly larger than those on the lower floors because of the reducing thickness of the structural walls on the upper floors. (Note: This statement required in Section 10(2)(e) in Part 1 of Schedule 1 of the Residential Properties (First-hand Sales) Ordinance (Cap.621) is not applicable to the Phase).

Notes:

- The dimensions in the floor plans are all structural dimensions in millimetre.
- Please refer to page 21 of this sales brochure for legend of the terms and abbreviations in studying the floor plans.

因住宅物業的較高樓層的結構牆的厚度遞減，較高樓層的內部面積，一般比較低樓層的內部面積稍大。(註：此根據《一手住宅物業銷售條例》(第621章)附表1第1部第10(2)(e)條所規定的陳述並不適用於期數)

附註：

- 樓面平面圖之尺規所列數字為以毫米標示之建築結構尺寸。
- 請參閱本售樓說明書第21頁之圖例以協助閱讀樓面平面圖之名稱和簡稱。

	Tower 座數	Floor 樓層	Units 單位					
			A	B	C	D	E	F
The thickness of the floor slabs (excluding plaster) of each residential property (mm) 每個住宅物業的樓板(不包括灰泥)的厚度(毫米)	Phase 3 Tower 1(1B) 第3期 第1座(1B)	31/F 31樓	150, 300	150, 300	150, 300	150, 300	150, 300	150, 300
The floor-to-floor height (i.e. the height between the top surface of the structural slab of a floor and the top surface of the structural slab of its immediate upper floor) of each residential property (mm) 每個住宅物業的層與層之間的高度(指該樓層之石屎地台面與上一層石屎地台面之高度距離)(毫米)			3200, 3500	3200, 3500	3200, 3500	3200, 3500	3200, 3500	3200, 3500

The internal areas of the residential properties on the upper floors will generally be slightly larger than those on the lower floors because of the reducing thickness of the structural walls on the upper floors. (Note: This statement required in Section 10(2)(e) in Part 1 of Schedule 1 of the Residential Properties (First-hand Sales) Ordinance (Cap.621) is not applicable to the Phase).

Notes:

- The dimensions in the floor plans are all structural dimensions in millimetre.
- Please refer to page 21 of this sales brochure for legend of the terms and abbreviations in studying the floor plans.

因住宅物業的較高樓層的結構牆的厚度遞減，較高樓層的內部面積，一般比較低樓層的內部面積稍大。(註：此根據《一手住宅物業銷售條例》(第621章)附表1第1部第10(2)(e)條所規定的陳述並不適用於期數)

附註：

- 樓面平面圖之尺規所列數字為以毫米標示之建築結構尺寸。
- 請參閱本售樓說明書第21頁之圖例以協助閱讀樓面平面圖之名稱和簡稱。

Phase 3 Tower 1(1B) 32/F Floor Plan
第3期 第1座(1B) 32樓樓面平面圖

Scale: 1:500
比例: 0M/米 5M (米) S

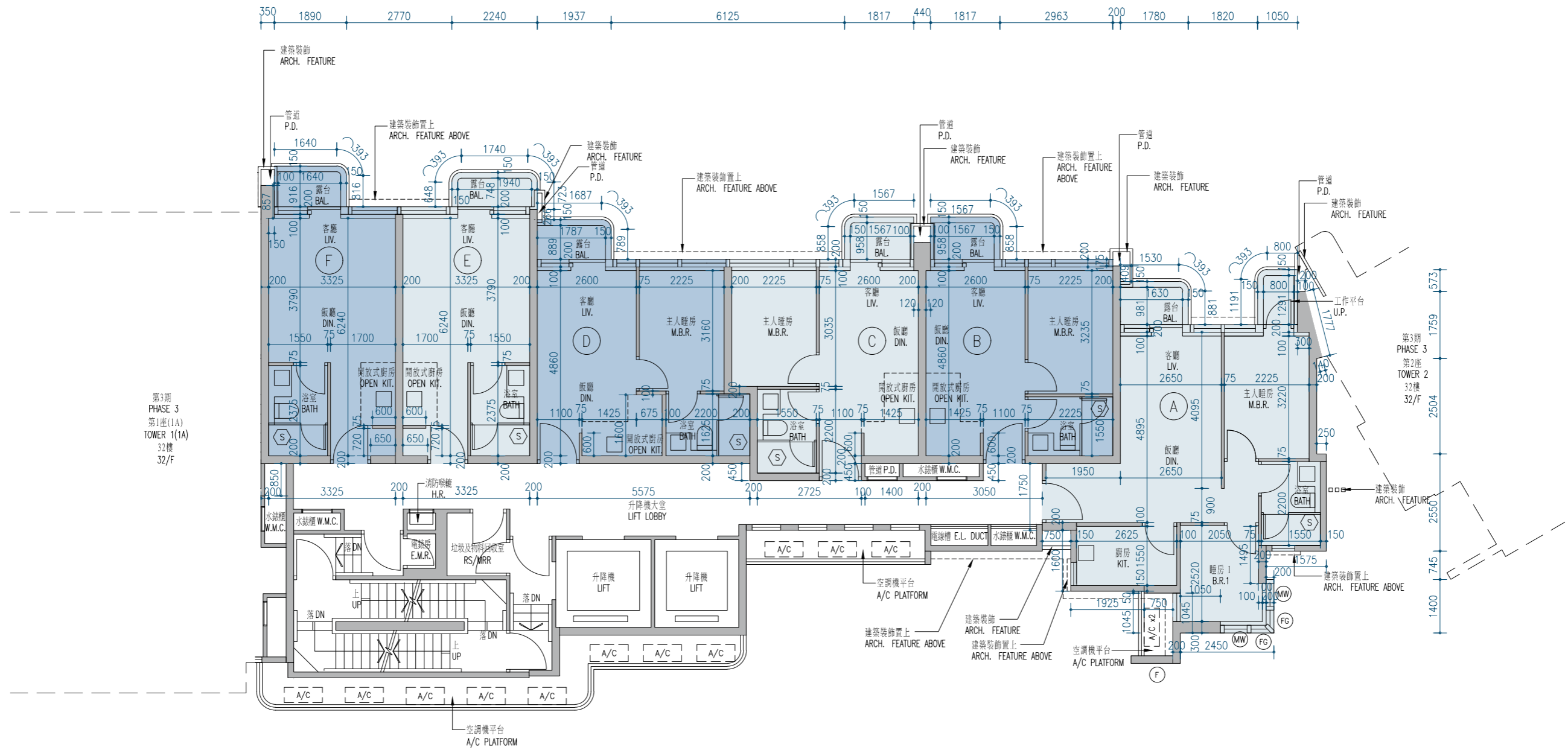

	Tower 座數	Floor 樓層	Units 單位					
			A	B	C	D	E	F
The thickness of the floor slabs (excluding plaster) of each residential property (mm) 每個住宅物業的樓板(不包括灰泥)的厚度(毫米)	Phase 3 Tower 1(1B) 第3期 第1座(1B)	32/F 32樓	150, 200, 300	150, 200, 300	150, 200, 300	150, 200, 300	150, 200, 300	150, 200, 300
The floor-to-floor height (i.e. the height between the top surface of the structural slab of a floor and the top surface of the structural slab of its immediate upper floor) of each residential property (mm) 每個住宅物業的層與層之間的高度(指該樓層之石屎地台面與上一層石屎地台面之高度距離)(毫米)			3350	3350	3350, 3750	3350, 3750	3350' 3750	3350' 3750

The internal areas of the residential properties on the upper floors will generally be slightly larger than those on the lower floors because of the reducing thickness of the structural walls on the upper floors. (Note: This statement required in Section 10(2)(e) in Part 1 of Schedule 1 of the Residential Properties (First-hand Sales) Ordinance (Cap.621) is not applicable to the Phase).

Notes:

- The dimensions in the floor plans are all structural dimensions in millimetre.
- Please refer to page 21 of this sales brochure for legend of the terms and abbreviations in studying the floor plans.

因住宅物業的較高樓層的結構牆的厚度遞減，較高樓層的內部面積，一般比較低樓層的內部面積稍大。(註：此根據《一手住宅物業銷售條例》(第621章)附表1第1部第10(2)(e)條所規定的陳述並不適用於期數)

附註：

- 樓面平面圖之尺規所列數字為以毫米標示之建築結構尺寸。
- 請參閱本售樓說明書第21頁之圖例以協助閱讀樓面平面圖之名稱和簡稱。

Phase 3 Tower 2 1/F Floor Plan
第3期 第2座 1樓樓面平面圖

Scale: 5M (米)
比例: 0M/米

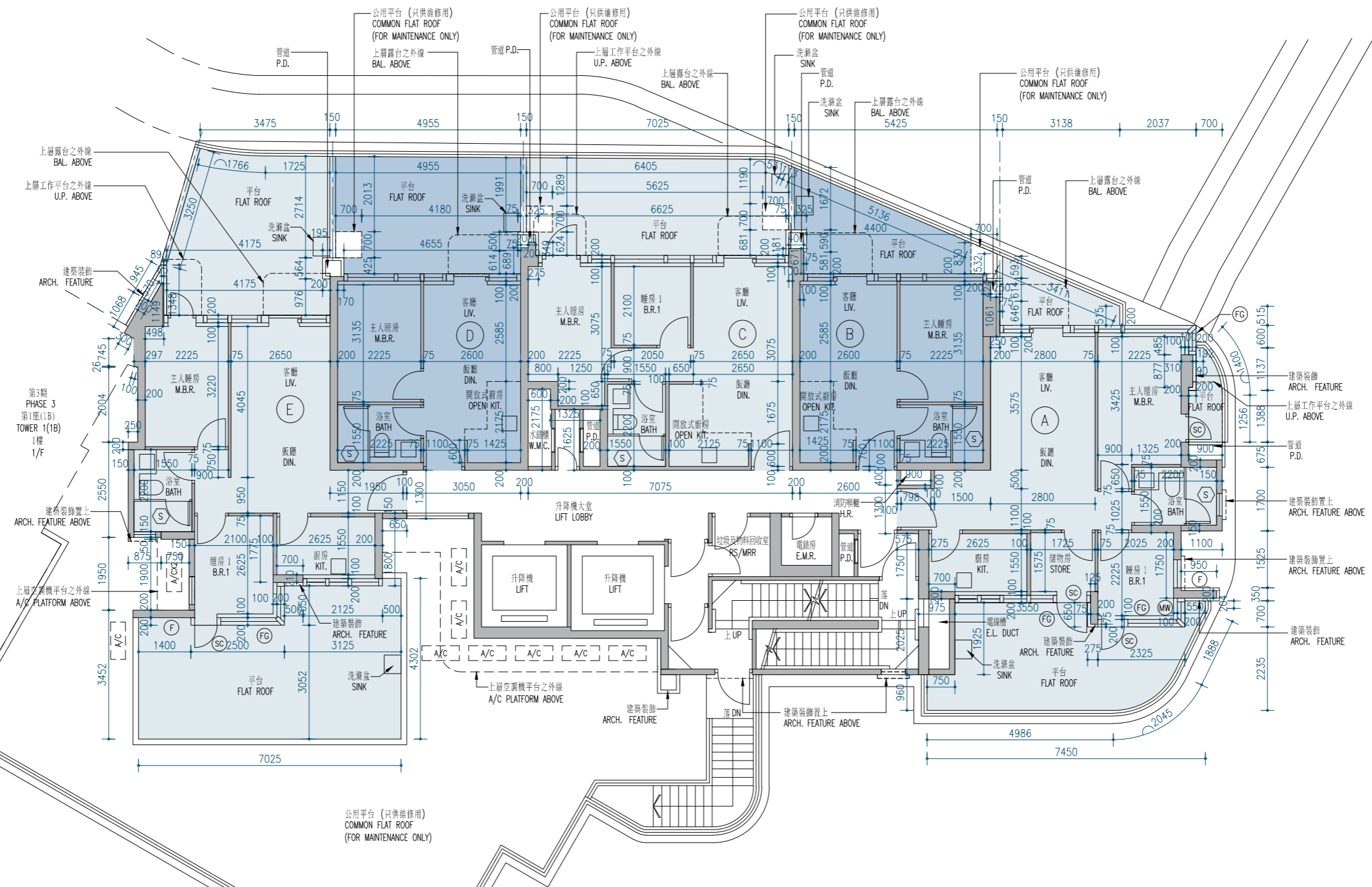

	Tower 座數	Floor 樓層	Units 單位				
			A	B	C	D	E
The thickness of the floor slabs (excluding plaster) of each residential property (mm) 每個住宅物業的樓板(不包括灰泥)的厚度(毫米)	Phase 3 Tower 2 第3期 第2座	1/F 1樓	150, 300	150, 300	150, 300	150, 300	150, 300
The floor-to-floor height (i.e. the height between the top surface of the structural slab of a floor and the top surface of the structural slab of its immediate upper floor) of each residential property (mm) 每個住宅物業的層與層之間的高度(指該樓層之石屎地台面與上一層石屎地台面之高度距離)(毫米)			2800, 3100	2800, 3100	2800, 3100	2800, 3100	2800, 3100

The internal areas of the residential properties on the upper floors will generally be slightly larger than those on the lower floors because of the reducing thickness of the structural walls on the upper floors. (Note: This statement required in Section 10(2)(e) in Part 1 of Schedule 1 of the Residential Properties (First-hand Sales) Ordinance (Cap.621) is not applicable to the Phase).

Notes:

1. The dimensions in the floor plans are all structural dimensions in millimetre.
2. Please refer to page 21 of this sales brochure for legend of the terms and abbreviations in studying the floor plans.

因住宅物業的較高樓層的結構牆的厚度遞減，較高樓層的內部面積，一般比較低樓層的內部面積稍大。(註：此根據《一手住宅物業銷售條例》(第621章)附表1第1部第10(2)(e)條所規定的陳述並不適用於期數)

附註：

1. 樓面平面圖之尺規所列數字為以毫米標示之建築結構尺寸。
2. 請參閱本售樓說明書第21頁之圖例以協助閱讀樓面平面圖之名稱和簡稱。

Phase 3 Tower 2 2/F-3/F, 5/F-12/F, 15/F-23/F, 25/F-32/F Floor Plan 第3期 第2座 2樓至3樓、5樓至12樓、15樓至23樓、25樓至32樓樓面平面圖

Scale: 5M (米)  S 

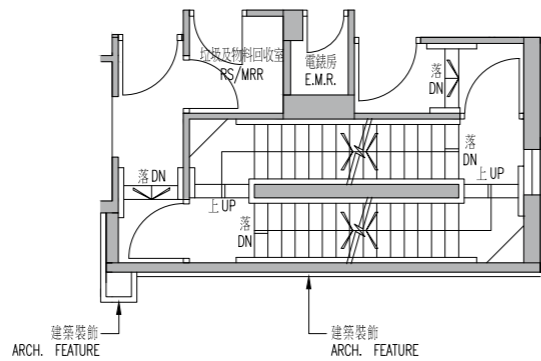
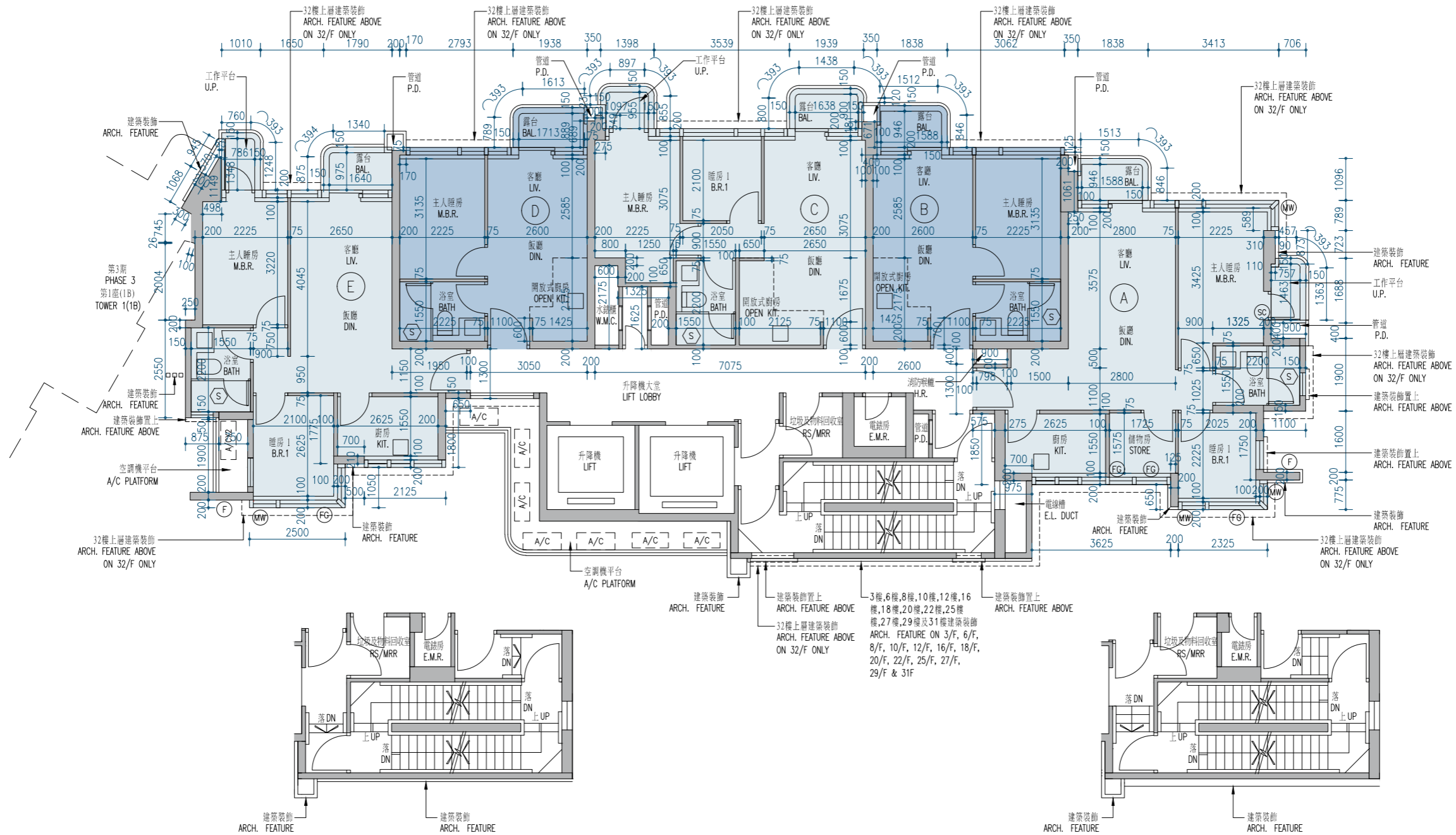

31/F Unit A Part Plan
31樓之部分平面圖

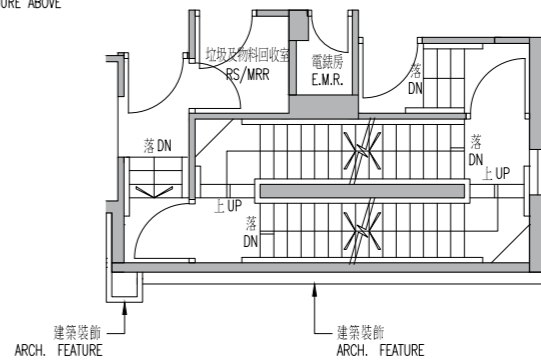

32/F Unit A Part Plan
32樓之部分平面圖

	Tower 座數	Floor 樓層	Units 單位				
			A	B	C	D	E
The thickness of the floor slabs (excluding plaster) of each residential property (mm) 每個住宅物業的樓板(不包括灰泥)的厚度(毫米)	Phase 3 Tower 2 第3期 第2座	2/F - 3/F, 5/F - 12/F, 15/F - 23/F, 25/F - 29/F 2樓至3樓、 5樓至12樓、 15樓至23樓、 25樓至29樓	150, 300	150, 300	150, 300	150, 300	150, 300
The floor-to-floor height (i.e. the height between the top surface of the structural slab of a floor and the top surface of the structural slab of its immediate upper floor) of each residential property (mm) 每個住宅物業的層與層之間的高度(指該樓層之石屎地台面與上一層石屎地台面之高度距離)(毫米)			2800, 3100	2800, 3100	2800, 3100	2800, 3100	2800, 3100
The thickness of the floor slabs (excluding plaster) of each residential property (mm) 每個住宅物業的樓板(不包括灰泥)的厚度(毫米)		30/F 30樓	150, 300	150, 300	150, 300	150, 300	150, 300
The floor-to-floor height (i.e. the height between the top surface of the structural slab of a floor and the top surface of the structural slab of its immediate upper floor) of each residential property (mm) 每個住宅物業的層與層之間的高度(指該樓層之石屎地台面與上一層石屎地台面之高度距離)(毫米)			3050, 3350	3050, 3350	3050, 3350	3050, 3350	3050, 3350
The thickness of the floor slabs (excluding plaster) of each residential property (mm) 每個住宅物業的樓板(不包括灰泥)的厚度(毫米)		31/F 31樓	150, 300	150, 300	150, 300	150, 300	150, 300
The floor-to-floor height (i.e. the height between the top surface of the structural slab of a floor and the top surface of the structural slab of its immediate upper floor) of each residential property (mm) 每個住宅物業的層與層之間的高度(指該樓層之石屎地台面與上一層石屎地台面之高度距離)(毫米)			3200, 3500	3200, 3500	3200, 3500	3200, 3500	3200, 3500
The thickness of the floor slabs (excluding plaster) of each residential property (mm) 每個住宅物業的樓板(不包括灰泥)的厚度(毫米)		32/F 32樓	150, 200, 300	150, 200, 300	150, 200, 300	150, 200, 300	150, 200, 300
The floor-to-floor height (i.e. the height between the top surface of the structural slab of a floor and the top surface of the structural slab of its immediate upper floor) of each residential property (mm) 每個住宅物業的層與層之間的高度(指該樓層之石屎地台面與上一層石屎地台面之高度距離)(毫米)			3500, 3900	3500, 3900	3500, 3900	3500	3500

The internal areas of the residential properties on the upper floors will generally be slightly larger than those on the lower floors because of the reducing thickness of the structural walls on the upper floors. (Note: This statement required in Section 10(2)(e) in Part 1 of Schedule 1 of the Residential Properties (First-hand Sales) Ordinance (Cap.621) is not applicable to the Phase).

Notes:

- The dimensions in the floor plans are all structural dimensions in millimetre.
- Please refer to page 21 of this sales brochure for legend of the terms and abbreviations in studying the floor plans.

因住宅物業的較高樓層的結構牆的厚度遞減，較高樓層的內部面積，一般比較低樓層的內部面積稍大。(註：此根據《一手住宅物業銷售條例》(第621章)附表1第1部第10(2)(e)條所規定的陳述並不適用於期數)

附註：

- 樓面平面圖之尺規所列數字為以毫米標示之建築結構尺寸。
- 請參閱本售樓說明書第21頁之圖例以協助閱讀樓面平面圖之名稱和簡稱。

Description of Residential Property 物業的描述			Saleable Area (including balcony, utility platform and verandah, if any) sq. metre (sq. ft.) 實用面積 (包括露台, 工作平台及陽台(如有)) 平方米 (平方呎)	Area of other specified items (Not included in the Saleable Area) sq. metre (sq. ft.) 其他指明項目的面積 (不計算入實用面積) 平方米 (平方呎)										
Tower 座數	Floor 樓層	Unit 單位		Air-conditioning plant room 空調機房	Bay window 窗台	Cockloft 閣樓	Flat roof 平台	Garden 花園	Parking space 停車位	Roof 天台	Stairhood 梯屋	Terrace 前庭	Yard 庭院	
Phase 3 Tower 1(1A) 第3期 第1座(1A)	1/F 1樓	A	85.980 (925) Balcony 露台 :- Verandah 陽台 :- Utility Platform 工作平台 :-	-	-	-	7.751 (83)	-	-	-	-	-	-	
		B	89.517 (964) Balcony 露台 :- Verandah 陽台 :- Utility Platform 工作平台 :-	-	-	-	52.381 (564)	-	-	-	-	-	-	
	2/F - 3/F, 5/F - 12/F, 15/F - 23/F, 25/F - 30/F 2樓至3樓、 5樓至12樓、 15樓至23樓、 25樓至30樓	A	90.762 (977) Balcony 露台 : 3.282 (35) Verandah 陽台 :- Utility Platform 工作平台 : 1.500 (16)	-	-	-	-	-	-	-	-	-	-	-
		B	92.967 (1001) Balcony 露台 : 3.356 (36) Verandah 陽台 :- Utility Platform 工作平台 : 1.500 (16)	-	-	-	-	-	-	-	-	-	-	-
	31/F - 32/F (Duplex) 31樓至32樓 (複式)	A	149.709 (1611) Balcony 露台 :- Verandah 陽台 :- Utility Platform 工作平台 :-	-	-	-	28.952 (312)	-	-	54.544 (587)	-	-	-	-
		B	130.805 (1408) Balcony 露台 :- Verandah 陽台 :- Utility Platform 工作平台 :-	-	-	-	28.547 (307)	-	-	-	-	-	-	-

The saleable area of each residential property and the floor areas of balcony, utility platform and verandah (if any) to the extent that it forms part of the residential property are calculated in accordance with section 8 of the Residential Properties (First-hand Sales) Ordinance; and the areas of other specified items (if any), to the extent that they form part of the residential property (not included in salesable area) are calculated in accordance with Part 2 of Schedule 2 of the Residential Properties (First-hand Sales) Ordinance.

Notes:

- The above areas have been converted to square feet based on a conversion rate of 1 square metre=10.764 square feet and rounded off to the nearest integer and may be slightly different from that shown in square metre.
- There is no verandah in the residential properties in the Phase.
- 4/F, 13/F, 14/F, 24/F for all Towers are omitted.

每個住宅物業的實用面積以及構成住宅物業的一部份的範圍內的露台、工作平台及陽台（如有）之樓面面積，是按照《一手住宅物業銷售條例》第8條計算得出的。在構成住宅物業的一部份的範圍內的其他指明項目（如有）的面積（不計算入實用面積），是按照《一手住宅物業銷售條例》附表2第2部計算得出的。

附註:

- 上述所列之面積以1平方米=10.764平方呎換算至平方呎，並四捨五入至整數。平方呎與平方米之數字可能有些微差異。
- 期數住宅物業並無陽台。
- 所有座數不設4樓、13樓、14樓及24樓。

Description of Residential Property 物業的描述			Saleable Area (including balcony, utility platform and verandah, if any) sq. metre (sq. ft.) 實用面積 (包括露台, 工作平台及陽台(如有)) 平方米 (平方呎)	Area of other specified items (Not included in the Saleable Area) sq. metre (sq. ft.) 其他指明項目的面積 (不計算入實用面積) 平方米 (平方呎)									
Tower 座數	Floor 樓層	Unit 單位		Air-conditioning plant room 空調機房	Bay window 窗台	Cockloft 閣樓	Flat roof 平台	Garden 花園	Parking space 停車位	Roof 天台	Stairhood 梯屋	Terrace 前庭	Yard 庭院
Phase 3 Tower 1(1B) 第3期 第1座(1B)	1/F 1樓	A	45.191 (486) Balcony 露台 :- Verandah 陽台 :- Utility Platform 工作平台 :-	-	-	-	40.534 (436)	-	-	-	-	-	-
		B	27.262 (293) Balcony 露台 :- Verandah 陽台 :- Utility Platform 工作平台 :-	-	-	-	13.758 (148)	-	-	-	-	-	-
		C	27.496 (296) Balcony 露台 :- Verandah 陽台 :- Utility Platform 工作平台 :-	-	-	-	13.680 (147)	-	-	-	-	-	-
		D	28.740 (309) Balcony 露台 :- Verandah 陽台 :- Utility Platform 工作平台 :-	-	-	-	13.338 (144)	-	-	-	-	-	-
		E	23.778 (256) Balcony 露台 :- Verandah 陽台 :- Utility Platform 工作平台 :-	-	-	-	5.188 (56)	-	-	-	-	-	-
		F	23.841 (257) Balcony 露台 :- Verandah 陽台 :- Utility Platform 工作平台 :-	-	-	-	4.773 (51)	-	-	-	-	-	-
		G	28.739 (309) Balcony 露台 :- Verandah 陽台 :- Utility Platform 工作平台 :-	-	-	-	14.885 (160)	-	-	-	-	-	-

The saleable area of each residential property and the floor areas of balcony, utility platform and verandah (if any) to the extent that it forms part of the residential property are calculated in accordance with section 8 of the Residential Properties (First-hand Sales) Ordinance; and the areas of other specified items (if any), to the extent that they form part of the residential property (not included in salesable area) are calculated in accordance with Part 2 of Schedule 2 of the Residential Properties (First-hand Sales) Ordinance.

Notes:

- The above areas have been converted to square feet based on a conversion rate of 1 square metre=10.764 square feet and rounded off to the nearest integer and may be slightly different from that shown in square metre.
- There is no verandah in the residential properties in the Phase.
- 4/F, 13/F, 14/F, 24/F for all Towers are omitted.

每個住宅物業的實用面積以及構成住宅物業的一部份的範圍內的露台、工作平台及陽台（如有）之樓面面積，是按照《一手住宅物業銷售條例》第8條計算得出的。在構成住宅物業的一部份的範圍內的其他指明項目（如有）的面積（不計算入實用面積），是按照《一手住宅物業銷售條例》附表2第2部計算得出的。

附註:

- 上述所列之面積以1平方米=10.764平方呎換算至平方呎，並四捨五入至整數。平方呎與平方米之數字可能有些微差異。
- 期數住宅物業並無陽台。
- 所有座數不設4樓、13樓、14樓及24樓。

Description of Residential Property 物業的描述			Saleable Area (including balcony, utility platform and verandah, if any) sq. metre (sq. ft.) 實用面積 (包括露台, 工作平台及陽台(如有)) 平方米 (平方呎)	Area of other specified items (Not included in the Saleable Area) sq. metre (sq. ft.) 其他指明項目的面積 (不計算入實用面積) 平方米 (平方呎)										
Tower 座數	Floor 樓層	Unit 單位		Air-conditioning plant room 空調機房	Bay window 窗台	Cockloft 閣樓	Flat roof 平台	Garden 花園	Parking space 停車位	Roof 天台	Stairhood 梯屋	Terrace 前庭	Yard 庭院	
Phase 3 Tower 1(1B) 第3期 第1座(1B)	2/F - 3/F, 5/F - 12/F, 15/F - 23/F, 25/F - 30/F 2樓至3樓、 5樓至12樓、 15樓至23樓、 25樓至30樓	A	48.690 (524) Balcony 露台: 2.000 (22) Verandah 陽台: - Utility Platform 工作平台: 1.500 (16)	-	-	-	-	-	-	-	-	-	-	
		B	29.262 (315) Balcony 露台: 2.000 (22) Verandah 陽台: - Utility Platform 工作平台: -	-	-	-	-	-	-	-	-	-	-	
		C	29.496 (317) Balcony 露台: 2.000 (22) Verandah 陽台: - Utility Platform 工作平台: -	-	-	-	-	-	-	-	-	-	-	-
		D	30.740 (331) Balcony 露台: 2.000 (22) Verandah 陽台: - Utility Platform 工作平台: -	-	-	-	-	-	-	-	-	-	-	-
		E	25.778 (277) Balcony 露台: 2.000 (22) Verandah 陽台: - Utility Platform 工作平台: -	-	-	-	-	-	-	-	-	-	-	-
		F	25.841 (278) Balcony 露台: 2.000 (22) Verandah 陽台: - Utility Platform 工作平台: -	-	-	-	-	-	-	-	-	-	-	-
		G	30.739 (331) Balcony 露台: 2.000 (22) Verandah 陽台: - Utility Platform 工作平台: -	-	-	-	-	-	-	-	-	-	-	-

The saleable area of each residential property and the floor areas of balcony, utility platform and verandah (if any) to the extent that it forms part of the residential property are calculated in accordance with section 8 of the Residential Properties (First-hand Sales) Ordinance; and the areas of other specified items (if any), to the extent that they form part of the residential property (not included in salesable area) are calculated in accordance with Part 2 of Schedule 2 of the Residential Properties (First-hand Sales) Ordinance.

Notes:

- The above areas have been converted to square feet based on a conversion rate of 1 square metre=10.764 square feet and rounded off to the nearest integer and may be slightly different from that shown in square metre.
- There is no verandah in the residential properties in the Phase.
- 4/F, 13/F, 14/F, 24/F for all Towers are omitted.

每個住宅物業的實用面積以及構成住宅物業的一部份的範圍內的露台、工作平台及陽台（如有）之樓面面積，是按照《一手住宅物業銷售條例》第8條計算得出的。在構成住宅物業的一部份的範圍內的其他指明項目（如有）的面積（不計算入實用面積），是按照《一手住宅物業銷售條例》附表2第2部計算得出的。

附註:

- 上述所列之面積以1平方米=10.764平方呎換算至平方呎，並四捨五入至整數。平方呎與平方米之數字可能有些微差異。
- 期數住宅物業並無陽台。
- 所有座數不設4樓、13樓、14樓及24樓。

Description of Residential Property 物業的描述			Saleable Area (including balcony, utility platform and verandah, if any) sq. metre (sq. ft.) 實用面積 (包括露台, 工作平台及陽台(如有)) 平方米 (平方呎)	Area of other specified items (Not included in the Saleable Area) sq. metre (sq. ft.) 其他指明項目的面積 (不計算入實用面積) 平方米 (平方呎)									
Tower 座數	Floor 樓層	Unit 單位		Air-conditioning plant room 空調機房	Bay window 窗台	Cockloft 閣樓	Flat roof 平台	Garden 花園	Parking space 停車位	Roof 天台	Stairhood 梯屋	Terrace 前庭	Yard 庭院
Phase 3 Tower 1(1B) 第3期 第1座(1B)	31/F 31樓	A	48.691 (524) Balcony 露台: 2.000 (22) Verandah 陽台: - Utility Platform 工作平台: 1.500 (16)	-	-	-	-	-	-	-	-	-	-
		B	29.262 (315) Balcony 露台: 2.000 (22) Verandah 陽台: - Utility Platform 工作平台: -	-	-	-	-	-	-	-	-	-	-
		C	29.496 (317) Balcony 露台: 2.000 (22) Verandah 陽台: - Utility Platform 工作平台: -	-	-	-	-	-	-	-	-	-	-
		D	30.740 (331) Balcony 露台: 2.000 (22) Verandah 陽台: - Utility Platform 工作平台: -	-	-	-	-	-	-	-	-	-	-
		E	25.778 (277) Balcony 露台: 2.000 (22) Verandah 陽台: - Utility Platform 工作平台: -	-	-	-	-	-	-	-	-	-	-
		F	25.938 (279) Balcony 露台: 2.000 (22) Verandah 陽台: - Utility Platform 工作平台: -	-	-	-	-	-	-	-	-	-	-

The saleable area of each residential property and the floor areas of balcony, utility platform and verandah (if any) to the extent that it forms part of the residential property are calculated in accordance with section 8 of the Residential Properties (First-hand Sales) Ordinance; and the areas of other specified items (if any), to the extent that they form part of the residential property (not included in salesable area) are calculated in accordance with Part 2 of Schedule 2 of the Residential Properties (First-hand Sales) Ordinance.

Notes:

- The above areas have been converted to square feet based on a conversion rate of 1 square metre=10.764 square feet and rounded off to the nearest integer and may be slightly different from that shown in square metre.
- There is no verandah in the residential properties in the Phase.
- 4/F, 13/F, 14/F, 24/F for all Towers are omitted.

每個住宅物業的實用面積以及構成住宅物業的一部份的範圍內的露台、工作平台及陽台（如有）之樓面面積，是按照《一手住宅物業銷售條例》第8條計算得出的。在構成住宅物業的一部份的範圍內的其他指明項目（如有）的面積（不計算入實用面積），是按照《一手住宅物業銷售條例》附表2第2部計算得出的。

附註:

- 上述所列之面積以1平方米=10.764平方呎換算至平方呎，並四捨五入至整數。平方呎與平方米之數字可能有些微差異。
- 期數住宅物業並無陽台。
- 所有座數不設4樓、13樓、14樓及24樓。

Description of Residential Property 物業的描述			Saleable Area (including balcony, utility platform and verandah, if any) sq. metre (sq. ft.) 實用面積 (包括露台, 工作平台及陽台(如有)) 平方米 (平方呎)	Area of other specified items (Not included in the Saleable Area) sq. metre (sq. ft.) 其他指明項目的面積 (不計算入實用面積) 平方米 (平方呎)									
Tower 座數	Floor 樓層	Unit 單位		Air-conditioning plant room 空調機房	Bay window 窗台	Cockloft 閣樓	Flat roof 平台	Garden 花園	Parking space 停車位	Roof 天台	Stairhood 梯屋	Terrace 前庭	Yard 庭院
Phase 3 Tower 1(1B) 第3期 第1座(1B)	32/F 32樓	A	48.691 (524) Balcony 露台: 2.000 (22) Verandah 陽台: - Utility Platform 工作平台: 1.500 (16)	-	-	-	-	-	-	-	-	-	-
		B	29.262 (315) Balcony 露台: 2.000 (22) Verandah 陽台: - Utility Platform 工作平台: -	-	-	-	-	-	-	-	-	-	-
		C	29.496 (317) Balcony 露台: 2.000 (22) Verandah 陽台: - Utility Platform 工作平台: -	-	-	-	-	-	-	-	-	-	-
		D	30.740 (331) Balcony 露台: 2.000 (22) Verandah 陽台: - Utility Platform 工作平台: -	-	-	-	-	-	-	-	-	-	-
		E	25.778 (277) Balcony 露台: 2.000 (22) Verandah 陽台: - Utility Platform 工作平台: -	-	-	-	-	-	-	-	-	-	-
		F	25.938 (279) Balcony 露台: 2.000 (22) Verandah 陽台: - Utility Platform 工作平台: -	-	-	-	-	-	-	-	-	-	-

The saleable area of each residential property and the floor areas of balcony, utility platform and verandah (if any) to the extent that it forms part of the residential property are calculated in accordance with section 8 of the Residential Properties (First-hand Sales) Ordinance; and the areas of other specified items (if any), to the extent that they form part of the residential property (not included in salesable area) are calculated in accordance with Part 2 of Schedule 2 of the Residential Properties (First-hand Sales) Ordinance.

Notes:

- The above areas have been converted to square feet based on a conversion rate of 1 square metre=10.764 square feet and rounded off to the nearest integer and may be slightly different from that shown in square metre.
- There is no verandah in the residential properties in the Phase.
- 4/F, 13/F, 14/F, 24/F for all Towers are omitted.

每個住宅物業的實用面積以及構成住宅物業的一部份的範圍內的露台、工作平台及陽台（如有）之樓面面積，是按照《一手住宅物業銷售條例》第8條計算得出的。在構成住宅物業的一部份的範圍內的其他指明項目（如有）的面積（不計算入實用面積），是按照《一手住宅物業銷售條例》附表2第2部計算得出的。

附註:

- 上述所列之面積以1平方米=10.764平方呎換算至平方呎，並四捨五入至整數。平方呎與平方米之數字可能有些微差異。
- 期數住宅物業並無陽台。
- 所有座數不設4樓、13樓、14樓及24樓。

Description of Residential Property 物業的描述			Saleable Area (including balcony, utility platform and verandah, if any) sq. metre (sq. ft.) 實用面積 (包括露台, 工作平台及陽台(如有)) 平方米 (平方呎)	Area of other specified items (Not included in the Saleable Area) sq. metre (sq. ft.) 其他指明項目的面積 (不計算入實用面積) 平方米 (平方呎)									
Tower 座數	Floor 樓層	Unit 單位		Air-conditioning plant room 空調機房	Bay window 窗台	Cockloft 閣樓	Flat roof 平台	Garden 花園	Parking space 停車位	Roof 天台	Stairhood 梯屋	Terrace 前庭	Yard 庭院
Phase 3 Tower 2 第3期 第2座	1/F 1樓	A	50.797 (547) Balcony 露台 :- Verandah 陽台 :- Utility Platform 工作平台 :-	-	-	-	20.288 (218)	-	-	-	-	-	-
		B	26.972 (290) Balcony 露台 :- Verandah 陽台 :- Utility Platform 工作平台 :-	-	-	-	7.665 (83)	-	-	-	-	-	-
		C	38.242 (412) Balcony 露台 :- Verandah 陽台 :- Utility Platform 工作平台 :-	-	-	-	16.322 (176)	-	-	-	-	-	-
		D	26.937 (290) Balcony 露台 :- Verandah 陽台 :- Utility Platform 工作平台 :-	-	-	-	14.134 (152)	-	-	-	-	-	-
		E	45.282 (487) Balcony 露台 :- Verandah 陽台 :- Utility Platform 工作平台 :-	-	-	-	40.577 (437)	-	-	-	-	-	-

The saleable area of each residential property and the floor areas of balcony, utility platform and verandah (if any) to the extent that it forms part of the residential property are calculated in accordance with section 8 of the Residential Properties (First-hand Sales) Ordinance; and the areas of other specified items (if any), to the extent that they form part of the residential property (not included in salesable area) are calculated in accordance with Part 2 of Schedule 2 of the Residential Properties (First-hand Sales) Ordinance.

Notes:

- The above areas have been converted to square feet based on a conversion rate of 1 square metre=10.764 square feet and rounded off to the nearest integer and may be slightly different from that shown in square metre.
- There is no verandah in the residential properties in the Phase.
- 4/F, 13/F, 14/F, 24/F for all Towers are omitted.

每個住宅物業的實用面積以及構成住宅物業的一部份的範圍內的露台、工作平台及陽台（如有）之樓面面積，是按照《一手住宅物業銷售條例》第8條計算得出的。在構成住宅物業的一部份的範圍內的其他指明項目（如有）的面積（不計算入實用面積），是按照《一手住宅物業銷售條例》附表2第2部計算得出的。

附註:

- 上述所列之面積以1平方米=10.764平方呎換算至平方呎，並四捨五入至整數。平方呎與平方米之數字可能有些微差異。
- 期數住宅物業並無陽台。
- 所有座數不設4樓、13樓、14樓及24樓。

Description of Residential Property 物業的描述			Saleable Area (including balcony, utility platform and verandah, if any) sq. metre (sq. ft.) 實用面積 (包括露台, 工作平台及陽台(如有)) 平方米 (平方呎)	Area of other specified items (Not included in the Saleable Area) sq. metre (sq. ft.) 其他指明項目的面積 (不計算入實用面積) 平方米 (平方呎)									
Tower 座數	Floor 樓層	Unit 單位		Air-conditioning plant room 空調機房	Bay window 窗台	Cockloft 閣樓	Flat roof 平台	Garden 花園	Parking space 停車位	Roof 天台	Stairhood 梯屋	Terrace 前庭	Yard 庭院
Phase 3 Tower 2 第3期 第2座	2/F - 3/F, 5/F - 12/F, 15/F - 23/F, 25/F - 30/F 2樓至3樓、 5樓至12樓、 15樓至23樓、 25樓至30樓	A	54.297 (584) Balcony 露台 : 2.000 (22) Verandah 陽台 : - Utility Platform 工作平台 : 1.500 (16)	-	-	-	-	-	-	-	-	-	-
		B	28.972 (312) Balcony 露台 : 2.000 (22) Verandah 陽台 : - Utility Platform 工作平台 : -	-	-	-	-	-	-	-	-	-	-
		C	41.742 (449) Balcony 露台 : 2.000 (22) Verandah 陽台 : - Utility Platform 工作平台 : 1.500 (16)	-	-	-	-	-	-	-	-	-	-
		D	28.937 (311) Balcony 露台 : 2.000 (22) Verandah 陽台 : - Utility Platform 工作平台 : -	-	-	-	-	-	-	-	-	-	-
		E	48.782 (525) Balcony 露台 : 2.000 (22) Verandah 陽台 : - Utility Platform 工作平台 : 1.500 (16)	-	-	-	-	-	-	-	-	-	-

The saleable area of each residential property and the floor areas of balcony, utility platform and verandah (if any) to the extent that it forms part of the residential property are calculated in accordance with section 8 of the Residential Properties (First-hand Sales) Ordinance; and the areas of other specified items (if any), to the extent that they form part of the residential property (not included in salesable area) are calculated in accordance with Part 2 of Schedule 2 of the Residential Properties (First-hand Sales) Ordinance.

Notes:

- The above areas have been converted to square feet based on a conversion rate of 1 square metre=10.764 square feet and rounded off to the nearest integer and may be slightly different from that shown in square metre.
- There is no verandah in the residential properties in the Phase.
- 4/F, 13/F, 14/F, 24/F for all Towers are omitted.

每個住宅物業的實用面積以及構成住宅物業的一部份的範圍內的露台、工作平台及陽台（如有）之樓面面積，是按照《一手住宅物業銷售條例》第8條計算得出的。在構成住宅物業的一部份的範圍內的其他指明項目（如有）的面積（不計算入實用面積），是按照《一手住宅物業銷售條例》附表2第2部計算得出的。

附註:

- 上述所列之面積以1平方米=10.764平方呎換算至平方呎，並四捨五入至整數。平方呎與平方米之數字可能有些微差異。
- 期數住宅物業並無陽台。
- 所有座數不設4樓、13樓、14樓及24樓。

Description of Residential Property 物業的描述			Saleable Area (including balcony, utility platform and verandah, if any) sq. metre (sq. ft.) 實用面積 (包括露台, 工作平台及陽台(如有)) 平方米 (平方呎)	Area of other specified items (Not included in the Saleable Area) sq. metre (sq. ft.) 其他指明項目的面積 (不計算入實用面積) 平方米 (平方呎)										
Tower 座數	Floor 樓層	Unit 單位		Air-conditioning plant room 空調機房	Bay window 窗台	Cockloft 閣樓	Flat roof 平台	Garden 花園	Parking space 停車位	Roof 天台	Stairhood 梯屋	Terrace 前庭	Yard 庭院	
Phase 3 Tower 2 第3期 第2座	31/F - 32/F 31樓至32樓	A	54.297 (584) Balcony 露台 : 2.000 (22) Verandah 陽台 : - Utility Platform 工作平台 : 1.500 (16)	-	-	-	-	-	-	-	-	-	-	
		B	28.972 (312) Balcony 露台 : 2.000 (22) Verandah 陽台 : - Utility Platform 工作平台 : -	-	-	-	-	-	-	-	-	-	-	-
		C	41.742 (449) Balcony 露台 : 2.000 (22) Verandah 陽台 : - Utility Platform 工作平台 : 1.500 (16)	-	-	-	-	-	-	-	-	-	-	-
		D	28.937 (311) Balcony 露台 : 2.000 (22) Verandah 陽台 : - Utility Platform 工作平台 : -	-	-	-	-	-	-	-	-	-	-	-
		E	48.782 (525) Balcony 露台 : 2.000 (22) Verandah 陽台 : - Utility Platform 工作平台 : 1.500 (16)	-	-	-	-	-	-	-	-	-	-	-

The saleable area of each residential property and the floor areas of balcony, utility platform and verandah (if any) to the extent that it forms part of the residential property are calculated in accordance with section 8 of the Residential Properties (First-hand Sales) Ordinance; and the areas of other specified items (if any), to the extent that they form part of the residential property (not included in salesable area) are calculated in accordance with Part 2 of Schedule 2 of the Residential Properties (First-hand Sales) Ordinance.

Notes:

- The above areas have been converted to square feet based on a conversion rate of 1 square metre=10.764 square feet and rounded off to the nearest integer and may be slightly different from that shown in square metre.
- There is no verandah in the residential properties in the Phase.
- 4/F, 13/F, 14/F, 24/F for all Towers are omitted.

每個住宅物業的實用面積以及構成住宅物業的一部份的範圍內的露台、工作平台及陽台（如有）之樓面面積，是按照《一手住宅物業銷售條例》第8條計算得出的。在構成住宅物業的一部份的範圍內的其他指明項目（如有）的面積（不計算入實用面積），是按照《一手住宅物業銷售條例》附表2第2部計算得出的。

附註:

- 上述所列之面積以1平方米=10.764平方呎換算至平方呎，並四捨五入至整數。平方呎與平方米之數字可能有些微差異。
- 期數住宅物業並無陽台。
- 所有座數不設4樓、13樓、14樓及24樓。

13 FLOOR PLANS OF PARKING SPACES IN THE PHASE

期數中的停車位的樓面平面圖

Not Applicable

不適用

14 SUMMARY OF PRELIMINARY AGREEMENT FOR SALE AND PURCHASE

臨時買賣合約的摘要

1. A preliminary deposit of 5% of the purchase price is payable on the signing of the preliminary agreement for sale and purchase (the preliminary agreement);
 2. The preliminary deposit paid by the purchaser on the signing of the preliminary agreement will be held by a firm of solicitors acting for the owner, as stakeholders;
 3. If the purchaser fails to execute the agreement for sale and purchase within 5 working days after the date on which the purchaser enters into the preliminary agreement-
 - (i) the preliminary agreement is terminated;
 - (ii) the preliminary deposit is forfeited; and
 - (iii) the owner does not have any further claim against the purchaser for the failure.
1. 在簽署臨時買賣合約（「該臨時合約」）時須支付款額為售價之5%的臨時訂金；
 2. 買方在簽署該臨時合約時支付的臨時訂金，會由代表擁有人行事的律師事務所以保證金保存人的身份持有；
 3. 如買方沒有於訂立該臨時合約的日期之後5個工作日內簽立買賣合約-
 - (i) 該臨時合約即告終止；
 - (ii) 有關的臨時訂金即予沒收；及
 - (iii) 擁有人不得就買方沒有簽立買賣合約而針對買方提出進一步申索。

The draft Deed of Mutual Covenant and Management Agreement of the Development (“DMC”) provides that:-

A. Common parts of the Development

1. The DMC provides for the following Common Areas and Common Facilities:-

- (i) “General Common Areas” means the Estate Common Areas, the Carpark Common Areas (after the execution of the Sub-Deed of Mutual Covenant in respect of the Carpark), the Residential Common Areas and all those parts of the Estate designated as common areas in any Sub-Deed(s) of Mutual Covenant which are designated as being for the common use and benefit of the relevant Owners in all Phases of the Estate.
- (ii) “General Common Facilities” means the Estate Common Facilities, the Carpark Common Facilities (after the execution of the Sub-Deed of Mutual Covenant in respect of the Carpark), the Residential Common Facilities and all such of the facilities of the Estate designated as common facilities in any Sub-Deed(s) of Mutual Covenant which are designated as being for the common use and benefit of the relevant Owners in all Phases of the Estate.
- (iii) “Estate Common Areas” means such of the lift lobby, transformer room, switch room, master meter room, such part or parts of the Slopes and Retaining Walls (if any) within the Land, , Fire Services (F.S.) water tank & pump rooms, switch room, , electrical switch room, Fire Services (FS) control room, , refuse storage material recovery, Drainage Reserve Areas, sprinkler pump rooms, Owners’ Committee’s office, caretaker’s office, Emergency Vehicular Access (EVA), parking space for refuse collection operation , emergency generator room, electrical vehicle (EV) charging room, irrigation pump & cleansing water pump room, extra-low voltage (ELV) room, carpark fan room, street fire hydrant (S.F.H.) water tank and pump room, smoke vents, delivery hatch, gas valve, air ducts, pipe ducts, other areas and spaces containing the Estate Common Facilities and other areas and spaces in any part or parts of the Estate which are designated as being for the common use and benefit of the Owners in all Phases of the Estate, provided that, where appropriate, if (a) any parts of the Estate covered by paragraph (a) of the definition of "common parts" set out in section 2 of the Building Management Ordinance and/or (b) any parts specified in the Schedule 1 to the Building Management Ordinance and included under paragraph (b) of the definition of "common parts" set out in section 2 of the Building Management Ordinance, shall also be covered by the provisions hereinbefore provided, such parts shall be deemed to have been included as, and shall form part of, the Estate Common Areas and the Estate Common Areas are for the purpose of identification shown coloured Indigo on the plan(s) (certified as to their accuracy by the Authorized Person) annexed to the DMC excluding those areas designated as being part of the Residential Common Areas, the Carpark Common Areas and the Premises.
- (iv) “Estate Common Facilities” means all equipment, facilities and systems designated as being for the use, benefit or service of the Estate Common Areas and for the common use and benefit of the Owners in all Phases of the Estate and without limiting the generality of the foregoing, include :

- (a) Such of the sewers, drains, water courses, pipes, gutters, wires and cables and other service facilities whether ducted or otherwise which are or at any time may be in, under or over or passing through the Estate through which water, sewage, gas, electricity and any other services are supplied to the Estate or any part or parts thereof;
 - (b) Fire services installation and equipment;
 - (c) Lamp posts, traffic lights and lighting within the Estate;
 - (d) Lightning conductor of the Estate;
 - (e) CCTV Imaging Device; and
 - (f) Other facilities and systems (other than those facilities designated as being part of the Residential Common Facilities or the Carpark Common Facilities) for the use and benefit of the Estate and not for the use and benefit of any particular Owner.
- (v) “Carpark Common Areas” means all the spaces and areas in the Carpark to be designated under the subsequent Sub-Deed of Mutual Covenant in respect of the Carpark and intended for the common use and benefit of the Parking Spaces (but excluding the Visitors’ Carparking Spaces and Parking Spaces for the Disabled Persons) including (but not limited to) fan rooms, EV charging rooms, smoke vents, circulation passages, void spaces, driveways, ramps, entrances, exits and other spaces or areas containing the Carpark Common Facilities, provided that, where appropriate, if (a) any parts of the Estate covered by paragraph (a) of the definition of “common parts” set out in section 2 of the Building Management Ordinance and/or (b) any parts specified in the Schedule 1 to the Building Management Ordinance and included under paragraph (b) of the definition of "common parts" set out in section 2 of the Building Management Ordinance, shall also be covered by the provisions hereinbefore provided, such parts shall be deemed to have been included as, and shall form part of, the Carpark Common Areas and the spaces or areas containing the Carpark Common Facilities and the Carpark Common Areas will be for the purpose of identification shown on the plan(s) to be annexed to the Sub-Deed of Mutual Covenant in respect of the Carpark (the accuracy of such plans will be certified by the Authorized Person) excluding those areas designated as being part of the Estate Common Areas, the Residential Common Areas and the Premises.
 - (vi) “Carpark Common Facilities” means such facilities, equipment, machines, apparatus and installations in, under or above the Land and the Estate to be designated under the subsequent Sub-Deed of Mutual Covenant in respect of the Carpark and for the common use benefit and service of the Parking Spaces (but excluding the Visitors’ Carparking Spaces and Parking Spaces for the Disabled Persons) only but no Owner of Carparking Spaces or Motorcycle Parking Spaces has the exclusive right to use or enjoy, and shall include (but not limited to) lighting, security system, fire service installation system, air-conditioning and mechanical ventilation system (if any) and other electrical, mechanical and sanitary installations within the Carpark Common Areas for the common use and benefit of the Parking Spaces excluding those being part of the Estate Common Facilities and the Residential Common Facilities.

- (vii) "Residential Common Areas" means such of the roofs (unless otherwise specifically included in the Unit), entrance lobbies, lift shafts, water tanks, flat roofs (other than those designated as being part of the Estate Common Areas and the Units), lift lobbies, lift machine rooms, staircases, corridors, external walls of the Residential Accommodation (including but not limited to the Curtain Walls and external parapet walls enclosing the roof or flat roof of a Unit), architectural features, non-structural prefabricated external walls, acoustic fins, parapet walls (other than those between Units or forming part of a Unit), the Recreational Areas and Facilities, filtration plant room, the Greenery Areas, potable & flushing water tank & pump rooms, emergency generator room, Fire Services (F.S.) water tank & pump rooms, low voltage (L.V.) switch rooms, water meter cabinets (W.M.C.), electrical ducts, pipe ducts (P.D.), refuse storage material recovery rooms (R.S.M.R.R.), electrical meter cabinets, air ducts (AD), air conditioning (A/C) platforms, electrical switch room, Visitors' Carparking Spaces, Parking Spaces for the Disabled Persons, the loading and unloading spaces provided pursuant to Special Condition No.(23) of the Government Grant, Private Open Space, telecommunications and broadcasting equipment rooms (T.B.E.), cleansing water pump room, switch room, water meter room (W.M.R.), electrical meter room (E.M.R.), hose reel (H.R.), extra-low voltage (E.L.V.) room, refuse room air duct, emergency generator room, cable riser duct, such areas and spaces containing the Residential Common Facilities and other areas and spaces in any part or parts of the Estate which are designated as being for the common use enjoyment and benefit of the Owners of the Residential Accommodation in all Phases of the Estate, provided that, where appropriate, if (a) any parts of the Estate covered by paragraph (a) of the definition of "common parts" set out in section 2 of the Building Management Ordinance and/or (b) any parts specified in the Schedule 1 to the Building Management Ordinance and included under paragraph (b) of the definition of "common parts" set out in section 2 of the Building Management Ordinance, shall also be covered by the provisions hereinbefore provided, such parts shall be deemed to have been included as, and shall form part of, the Residential Common Areas and the Residential Common Areas are for the purpose of identification shown coloured Yellow, Yellow Hatched Red, Yellow Stippled Black and Yellow Hatched Black on the plan(s) (certified as to their accuracy by the Authorized Person) annexed to the DMC excluding those areas designated as being part of the Estate Common Areas and the Carpark Common Areas and the Premises.
- (viii) "Residential Common Facilities" means all those facilities, equipment, machines, apparatus and installations in, under or above the Land and the Estate designated as being for the general benefit and service of the Residential Accommodation only but to which no Owner of a Unit has the exclusive right to use or enjoy the same including (but not limited to) Common Electric Vehicle Facilities, lighting pole, gondola, lifts, lighting, communal television antennae, water tanks, satellite dishes, recreational facilities, machinery or equipment for any lift, air-conditioning or heating system or any similar device, security system, fire service installation system and such electrical, mechanical and sanitary installations which are designated as being for the common use enjoyment and benefit of the Owners and residents of the Residential Accommodation in all Phases of the Estate excluding those facilities designated as being part of the Estate Common Facilities and the Carpark Common Facilities.
- (ix) "Common Electric Vehicle Facilities" means all such facilities installed or to be installed in the General Common Areas for the purpose of or in relation to the charging of electric motor vehicles or electric motor cycles licensed under the Road Traffic Ordinance (Chapter 374) and parked at the Visitors' Carparking Spaces, the Parking Spaces for the Disabled Persons, and such facilities shall include but not limited to such wires, cables, ducts, trunking, electrical vehicle chargers, electric

meters, base box, socket outlet, locks, covers and such other security and/or protective devices, equipment, apparatus and such other electrical or other installations or otherwise for or in relation to such purpose.

- "Sub-Deed of Mutual Covenant" means a sub-deed of mutual covenant which may be entered into by the First Owner and other parties in respect of any part or parts of the Land and the Estate after the execution of the DMC.
- No owners shall convert the General Common Areas and the General Common Facilities or any part thereof to his own use or for his own benefit unless approved by a resolution of the Owner's Committee.
- No part of the General Common Areas shall be obstructed or incumbered nor shall any refuse or other matter or things be placed or left thereon nor shall any part thereof be used for any business or private purpose and no Owner shall do or suffer or permit to be done anything therein as may be or become a nuisance or cause annoyance to any other Owners or Occupiers of the Estate.

B. Number of undivided shares assigned to each residential property in the Phase

Undivided Shares are allocated to each residential property. They are set out in the table annexed to this section of Sales Brochure.

Tower	Floor	Unit	No. of Undivided Shares allocated to each Unit
Phase 3 Tower 1 (1A)	1/F	A	87
		B	95
	2/F - 3/F, 5/F - 12/F, 15/F - 23/F, 25/F - 30/F	A	91
		B	93
	31/F - 32/F (Duplex)	A	158
		B	134

- a) First residential floor starts on 1/F and there is no designation of 4/F, 13/F, 14/F & 24/F.

Tower	Floor	Unit	No. of Undivided Shares allocated to each Unit
Phase 3 Tower 1 (1B)	1/F	A	49
		B	29
		C	29
		D	30
		E	24
		F	24
		G	30

Tower	Floor	Unit	No. of Undivided Shares allocated to each Unit
Phase 3 Tower 1 (1B)	2/F - 3/F, 5/F - 12/F, 15/F - 23/F, 25/F - 30/F	A	49
		B	29
		C	29
		D	31
		E	26
		F	26
		G	31
	31/F	A	49
		B	29
		C	29
		D	31
		E	26
		F	26
	32/F	A	49
		B	29
		C	29
		D	31
		E	26
F		26	

a) First residential floor starts on 1/F and there is no designation of 4/F, 13/F, 14/F & 24/F.

Tower	Floor	Unit	No. of Undivided Shares allocated to each Unit
Phase 3 Tower 2	1/F	A	53
		B	28
		C	40
		D	28
		E	49
	2/F - 3/F, 5/F - 12/F, 15/F - 23/F, 25/F - 30/F	A	54
		B	29
		C	42
		D	29
		E	49
	31/F - 32/F	A	54
		B	29
		C	42
		D	29
		E	49

a) First residential floor starts on 1/F and there is no designation of 4/F, 13/F, 14/F & 24/F.

C. Term of years for which the Manager of the Development is appointed

The Manager shall be appointed initially for a term of two (2) years commencing from the date of the DMC and such appointment shall continue thereafter until and unless termination by the Manager or the Owners' Committee (prior to formation of the Owners' Corporation) by giving not less than three (3) months' notice in writing in accordance with the terms of the DMC.

D. Basis on which the Management Expenses are shared among the owners of residential properties in the Development

The Management Expenses shall be apportioned between the Owners of the Estate in the following manner:-

- (a) Where any expenditure relates to the Residential Common Areas or the Residential Common Facilities providing services to the Owners of the Units, the expenditure shall form part of the Management Expenses of the Residential Accommodation and shall be borne by the Owners of the Units according to the proportions borne by the number of the Management Shares of their respective Units to the total number of Management Shares allocated to all the Units. Before the issuance of consent to assign of Phase 2 and/or Phase 3 or the certificate of compliance for the Land, the relevant budgeted Management Expenses in relation to Residential Common Areas and/or the Residential Common Facilities shall only show the estimated expenditure of the management and maintenance of the Residential Common Areas and the Residential Common Facilities within Phase 1 (and the Residential Common Areas and the Residential Common Facilities within Phase 2 if the same is completed). Upon the issuance of the consent to assign of Phase 2 and/or Phase 3 (as the case may be) or the certificate of compliance for the Land, the relevant budgeted Management Expenses in relation to Residential Common Areas and/or the Residential Common Facilities shall show the estimated expenditure of the management and maintenance of the Residential Common Areas and the Residential Common Facilities within Phase 1 and the Residential Common Areas and the Residential Common Facilities within Phase 2 or the Estate Common Areas and the Estate Common Facilities in the Estate as a whole (as the case may be).
- (b) Upon the execution of the Sub-Deed of Mutual Covenant in respect of the Carpark, any expenditure relates to the Carpark Common Areas or the Carpark Common Facilities providing services to the Parking Spaces shall form part of the Management Expenses of the Carpark and shall be borne by the Owners of the Parking Spaces (other than the Visitors' Carparking Spaces and Parking Spaces for the Disabled Persons) according to the proportions borne by the number of Management Shares of their respective Parking Spaces to the total number of Management Shares allocated to all the Parking Spaces (other than the Visitors' Carparking Spaces and Parking Spaces for the Disabled Persons).
- (c) Where any expenditure relates to (i) the Estate Common Areas and/or the Estate Common Facilities or (ii) does not fall under any of the sub-paragraphs (a) and (b) of this paragraph, the expenditure shall form part of the Management Expenses of the Estate as a whole and shall be borne by all Owners of the Estate in accordance with the proportion borne by the number of Management Shares of each Premises to the total number of Management Shares of the Estate. Before the issuance

of consent to assign of Phase 2 and/or Phase 3 or the certificate of compliance for the Land, the relevant budgeted Management Expenses in relation to Estate Common Areas and/or the Estate Common Facilities shall only show the estimated expenditure of the management and maintenance of the Estate Common Areas and the Estate Common Facilities within Phase 1 (and the Estate Common Areas and the Estate Common Facilities within Phase 2 if the same is completed). Upon the issuance of the consent to assign of Phase 2 and/or Phase 3 (as the case may be) or the certificate of compliance for the Land, the relevant budgeted Management Expenses in relation to Estate Common Areas and/or the Estate Common Facilities shall show the estimated expenditure of the management and maintenance of the Estate Common Areas and the Estate Common Facilities within Phase 1 and the Estate Common Areas and the Estate Common Facilities within Phase 2 or the Estate Common Areas and the Estate Common Facilities in the Estate as a whole (as the case may be).

- (d) Notwithstanding anything contained in sub-clauses (a) to (c) hereof, (i) where any expenditure relates solely to or is solely for the benefit of any Premises and no Owner other than the Owner entitled to the exclusive right and privilege to hold, use and occupy that Premises will receive any material benefit therefrom, then the full amount of such expenditure shall be borne by the Owner of such Premises and (ii) where any expenditure relates solely to or is solely for the benefit of a group of Owners but does not relate to or is not for the benefit of the other Owners, the full amount of such expenditure shall be apportioned between such Owners in proportion to their respective Management Shares.

E. Basis on which the Management Fee Deposit is fixed

The management fee deposit shall be a sum equivalent to 3 months' Management Fee.

F. Area (if any) in the Development retained by the owner for its own use

There is no area in the Development which is retained by the owner (Sky Asia Properties Limited) for that owner's use as referred to in section 14(2)(f), Part 1, Schedule 1 of Residential Properties (First-hand Sales) Ordinance.

發展項目公契及管理協議擬稿（「公契」）有下述條文：-

A. 發展項目的公用部分

1. 公契訂明下列公用地方及公用設施：-

- (i) 「一般公用地方」指屋苑公用地方、停車場公用地方（在簽立有關停車場的副公契後）、住宅公用地方及在任何副公契中被劃為公用地方，並供所有屋苑內所有期數的相關業主共同使用與享用而設的屋苑內所有該等部分。
- (ii) 「一般公用設施」指屋苑公用設施、停車場公用設施（在簽立有關停車場的副公契後）、住宅公用設施及在任何副公契中被劃為公用設施，並供所有屋苑內所有期數的相關業主共同使用與享用而設的屋苑內所有該等設施。
- (iii) 「屋苑公用地方」指升降機大堂、變壓器房、掣房、總錶房、該土地內斜坡及護土牆的部分（如有）、消防水箱及泵房、掣房、電掣房、消防控制室、垃圾儲存及物料回收渠專專用範圍、灑水器泵房、業主委員會辦事處、管理員辦事處、緊急車輛通道、停車位供垃圾收集車運作、緊急發電機房、電動汽車充電房、灌溉水泵及清潔水泵房、特低壓掣房、停車場通風機房、街道消防栓水缸泵房、排煙口、艙口、氣閥、排風管、管道槽、設有屋苑公用設施的其他地方與範圍和於屋苑所有期數任何部分被劃為供屋苑業主共同使用與共享的其他地方與範圍，倘若適用(a)《建築物管理條例》第2條列明的「公用部分」定義(a)分段涵蓋的屋苑的任何部分及/或(b)《建築物管理條例》第一附表指定並納入《建築物管理條例》第2條列明的「公用部分」定義(b)分段的任何部分，亦應被上文所列的條文涵蓋，該些部份應被視作已被包含在並構成屋苑公用地方一部份。屋苑公用地方在附錄於公契的圖則以靛藍色顯示供識別之用（經認可人士核實準確度），但不包括被劃為住宅公用地方、停車場公用地方及單位一部分的該等地方。
- (iv) 「屋苑公用設施」指為屋苑公用地方的使用、利益或服務及為屋苑所有期數業主的共同使用與享用而設的所有設備，設施及系統。茲毋損前文之一般規定，屋苑公用設施包括：-
 - (a) 現時或於任何時間位於屋苑之內、之下或之上或跨越其中的該等下水道、排水道、水道、管道、溝渠、電線與電纜及其他服務設施（不論有否鋪設管道），以將水、污水、氣體、電力及任何其他服務供應至屋苑或其任何部分；
 - (b) 滅火裝置與設備；
 - (c) 屋苑內燈柱、交通燈及照明設施；
 - (d) 屋苑的避雷裝置；
 - (e) 閉路電視影像設備；及

- (f) 為屋苑的使用及利益而設及並非為任何個別業主的使用及利益而設的其他設施及系統（被劃為住宅公用設施或停車場公用設施一部分的設施除外）。
- (v) 「停車場公用地方」指於停車場內，在其後有關停車場的副公契中被劃為，並擬供停車位共同使用與享用而設的所有範圍與地方（但不包括訪客停車位及傷健人士停車位），包括（但不限於）風機房、電動汽車充電房、排煙口、運轉通道、中空地方、行車道、斜路、入口、出口及設有停車場公用設施的其他範圍或地方，倘若適用(a)《建築物管理條例》第2條列明的「公用部分」定義(a)分段涵蓋的屋苑的任何部分及/或(b)《建築物管理條例》第一附表指定並納入《建築物管理條例》第2條列明的「公用部分」定義(b)分段的任何部分，亦應被上文所列的條文涵蓋，該些部份應被視作已被包含在並構成停車場公用地方及設有停車場公用設施的其他範圍或地方一部份。停車場公用地方將在附錄於有關停車場的副公契的圖則顯示供識別之用（該些圖則將經認可人士核實準確度），但不包括被劃為屋苑公用地方、住宅公用地方及單位一部分的該等地方。
- (vi) 「停車場公用設施」指於該土地及屋苑之內、之下或之上，在其後有關停車場的副公契中被劃為，並供停車位共同使用、享用及服務而設的該等設施、設備、機器、器具及裝置（但不包括訪客停車位及傷健人士停車位），亦非供任何停車位業主或電單車停車位業主獨家使用或享用，其中包括（但不限於）照明設施、保安系統、消防服務裝置系統、空調及機械通風系統（如有）及其他設於停車場公用地方內及供停車位共同使用與共享的電力、機械及衛生裝置，但不包括構成屋苑公用設施及住宅公用設施一部分的該等設施。
- (vii) 「住宅公用地方」指天台（指定納入單位的天台除外）、入口大堂、升降機槽、水箱、平台（被劃為屋苑公用設施及單位一部分的平台除外）、升降機大堂、升降機機房、樓梯、走廊、住宅樓宇的外牆（包括但不限於幕牆及圍封單位的天台及平台的外矮牆）、建築裝飾、非結構預製外牆、隔聲簷、矮牆（單位之間或構成單位一部分的矮牆除外）、康樂地方及設施、濾水器機房、綠化地方、沖廁水和食水水箱及泵房、緊急發電機房、消防水箱及泵房、低壓電房、水錶櫃、電線槽、管道槽、垃圾儲存及物料回收室、電錶櫃、排風管、空調機平台、電掣房、訪客停車位、傷健人士停車位、根據批地文件特別條件第(23)條而設的上落貨停車位、私人休憩用地、電訊及廣播設備室、清潔水泵房、掣房、水錶房、電錶房、消防喉轆、特低壓電房、垃圾房排氣管、緊急發電機房、電線管道、設有住宅公用設施的該等地方與範圍以及位於屋苑任何部分並供屋苑所有期數住宅樓宇的業主共同使用與共享而設的其他地方與範圍，倘若適用(a)《建築物管理條例》第2條列明的「公用部分」定義(a)分段涵蓋的屋苑的任何部分及或(b)《建築物管理條例》第一附表指定並納入《建築物管理條例》第2條列明的「公用部分」定義(b)分段的任何部分，亦應被上文所列的條文涵蓋，該些部份應被視作已被包含在並構成住宅公用地方一部份。住宅公用地方在附錄於公契的圖則以黃色、黃色加紅斜線、黃色綴黑網點及黃色加黑斜線顯示供識別之用（經認可人士核實準確度），但不包括被劃為屋苑公用地方、停車場公用地方及單位一部分的該等地方。
- (viii) 「住宅公用設施」指於該土地及屋苑之內、之下或之上被劃為住宅樓宇一般享用及服務而設，亦非供任何單位業主獨家使用或享用的設施、設備、機器、器具及裝置，其中包括（但不限於）公共電動車設施、避雷桿、吊船、升降機、照明設施、公共電視天線、水箱、衛星碟形天線、康樂設施、為任何升降機、空調或供暖系統而設的機械裝置或設備或任何類似的裝備、保安系統、消防服務裝置系統以及其他被劃為供屋苑內所有期數的住宅樓宇業主及住戶共同使用與享用的電力、機械及衛生裝置，但不包括被劃為屋苑公用設施及停車場公用設施部分的該等設施。

15 SUMMARY OF DEED OF MUTUAL COVENANT 公契的摘要

(ix) 「公共電動車設施」指為了或就停泊於訪客停車位、傷健人士停車位的根據《道路交通條例》(第374章)持牌的電動車或電動單車充電用途而在一般公用地方安裝或將安裝的所有設施，而該等設施包括但不限於為了或就該用途而設的電線、電纜、管道、幹槽、電動車充電器、電錶、基底盒、插座、鎖、蓋及其他保安及/或保護裝備、設備、器具及其他電力或其他裝置。

2. 「副公契」指於簽立公契後第一業主與其他各方就有關土地及屋苑任何部分訂立的副公契。
3. 除非獲業主委員會決議批准，業主不得將一般公用地方及一般公用設施或其任何一部分改為作自己使用或享用。
4. 業主不得阻塞或阻礙一般公用地方，或於一般公用地方放置或棄置垃圾或其他物件。業主不得使用一般公用地方的任何部分作商業或私人用途。業主亦不得於一般公用地方作出或容許任何對屋苑其他業主或佔用人造成滋擾的行為。

B. 分配予期數中的每個住宅物業的不分割份數的數目

各住宅物業配有不分割份數。詳細的分配狀況於本售樓說明書本節附表中列出。

座數	樓層	單位	每個單位獲分配的不分割份數數目
第3期 第1座 (1A)	1樓	A	87
		B	95
	2樓至3樓、 5樓至12樓、 15樓至23樓、 25樓至30樓	A	91
		B	93
	31樓至32樓 (複式)	A	158
		B	134

a) 首個住宅樓層由1樓開始及不設4樓、13樓、14樓及24樓。

座數	樓層	單位	每個單位獲分配的不分割份數數目
第3期 第1座 (1B)	1樓	A	49
		B	29
		C	29
		D	30
		E	24
		F	24
		G	30

座數	樓層	單位	每個單位獲分配的不分割份數數目
第3期 第1座 (1B)	2樓至3樓、 5樓至12樓、 15樓至23樓、 25樓至30樓	A	49
		B	29
		C	29
		D	31
		E	26
		F	26
		G	31
	31樓	A	49
		B	29
		C	29
		D	31
		E	26
		F	26
	32樓	A	49
		B	29
		C	29
		D	31
		E	26
F		26	

a) 首個住宅樓層由1樓開始及不設4樓、13樓、14樓及24樓。

座數	樓層	單位	每個單位獲分配的不分割份數數目
第3期 第2座	1樓	A	53
		B	28
		C	40
		D	28
		E	49
	2樓至3樓、 5樓至12樓、 15樓至23樓、 25樓至30樓	A	54
		B	29
		C	42
		D	29
		E	49
		31樓至32樓	A
	B		29
	C		42
	D		29
			E

a) 首個住宅樓層由1樓開始及不設4樓、13樓、14樓及24樓。

C. 發展項目的管理人的委任年期

管理人的最初任期為由公契的日期起計兩年，並於期滿後獲繼續委任，直至管理人或業主委員會（於業主立案法團成立前）根據公契條款給予對方不少於三個月書面通知以終止委任。

D. 管理開支按甚麼基準在發展項目中的住宅物業的擁有人之間分擔

屋苑的業主須按下列方式分攤管理開支：-

- (a) 如任何開支涉及為各單位業主提供服務之住宅公用地方或住宅公用設施，有關開支將計入住宅樓宇的管理開支部分，並由各單位業主按照彼等各自所持單位管理份數佔所有單位管理份數總額的比例分攤。在批出第二期及/或第三期的轉讓同意或土地的合約完成證明書前，有關住宅公用地方及/或住宅公用設施的相關管理開支只表示第一期內的住宅公用地方和住宅公用設施（如第二期已落成則包括其住宅公用地方和住宅公用設施）的管理與保養預算開支。在批出第二期及/或第三期的轉讓同意（視屬何情況而定）或土地的合約完成證明書後，有關住宅公用地方及/或住宅公用設施的相關管理開支表示第一期內的住宅公用地方和住宅公用設施及第二期內的住宅公用地方和住宅公用設施或屋苑整體內的屋苑公用地方及屋苑公用設施的管理與保養預算開支（視屬何情況而定）。
- (b) 在簽立有關停車場的副公契後，如任何開支涉及為各停車位提供服務之停車場公用地方或停車場公用設施，有關開支將計入停車場的管理開支，並由各停車位業主（訪客停車位及傷健人士停車位除外）按照彼等各自所持之停車位管理份數佔所有停車位管理份數總額的比例分擔。
- (c) 如任何開支涉及(i)屋苑公用地方及/或屋苑公用設施，或(ii)不屬於本條第(a)及(b)分段，則會計入屋苑整體管理開支，並由屋苑所有業主按照彼等各自所持之每單位管理份數佔屋苑管理份數總額的比例分擔。在批出第二期及/或第三期的轉讓同意或土地的合約完成證明書前，有關屋苑公用地方及/或屋苑公用設施的相關管理開支只表示第一期內的屋苑公用地方和屋苑公用設施（如第二期已落成則包括其屋苑公用地方和屋苑公用設施）的管理與保養預算開支。在批出第二期及/或第三期的轉讓同意（視屬何情況而定）或土地的合約完成證明書後，有關屋苑公用地方及/或屋苑公用設施的相關管理開支表示第一期內的屋苑公用地方和屋苑公用設施及第二期內的屋苑公用地方和屋苑公用設施或屋苑整體內的屋苑公用地方及屋苑公用設施的管理與保養預算開支（視屬何情況而定）。
- (d) 儘管上述第(a)至(c)分段有所規定，(i)凡任何開支純粹涉及或純粹為任何單位的利益而設，及沒有其他業主(具獨家權利及特權持有、使用及佔用該單位的業主除外)由此得到任何重大利益，該等開支須全數由該單位的業主承擔；及(ii)凡任何開支純粹涉及或純粹為一組業主的利益而設，但並不涉及其他業主或並非為其他業主的利益而設，該等開支須全數由該等業主按彼等各自管理份數分攤。

E. 計算管理費按金的基準

管理費按金須相等於三個月之管理費。

F. 擁有人在發展項目中保留作自用的範圍（如有的話）

擁有人（天基置業有限公司）在發展項目中並無《一手住宅物業銷售條例》附表1 第1部第14(2)(f)條所述之保留作自用的範圍。

1. The Development is constructed on The Remaining Portion of New Kowloon Inland Lot No.6549 (“**the Lot**”) which is held under Conditions of Sale No.20313 dated 15th December 2017 as varied or modified by an extension letter dated 26th August 2020 (“**the Land Grant**”).
2. The Lot is granted for a term of 50 years commencing from 15th December 2017.
3. Special Condition No.(3) of the Land Grant stipulates that: -
 “The lot or any part thereof or any building or part of any building erected or to be erected thereon shall not be used for any purpose other than for private residential purposes.”
4. General Condition No.(7)(a) of the Land Grant stipulates that: -
 “The Purchaser shall throughout the tenancy having built or rebuilt (which word refers to redevelopment as contemplated in sub-clause (b) of this General Condition) in accordance with these Conditions:
 - (i) maintain all buildings in accordance with the approved design and disposition and any approved building plans without variation or modification thereto; and
 - (ii) maintain all buildings erected or which may hereafter be erected in accordance with these Conditions or any subsequent contractual variation of them, in good and substantial repair and condition and in such repair and condition deliver up the same at the expiration or sooner determination of the tenancy.”
5. General Condition No.(7)(b) of the Land Grant stipulates that: -
 “In the event of the demolition at any time during the tenancy of any building then standing on the lot or any part thereof, the Purchaser shall replace the same either by sound and substantial building or buildings of the same type and of no less gross floor area or by building or buildings of such type and value as shall be approved by the Director. In the event of demolition as aforesaid, the Purchaser shall within one calendar month of such demolition apply to the Director for consent to carry out building works for the redevelopment of the lot and upon receiving such consent shall within three calendar months thereof commence the necessary redevelopment works and shall complete the same to the satisfaction of and within such time limit as is laid down by the Director.”
6. Special Condition No.(2) of the Land Grant stipulates that: -
 “The Purchaser shall develop the lot by the erection thereon of a building or buildings complying in all respects with these Conditions and all Ordinances, bye-laws and regulations relating to building, sanitation and planning which are or may at any time be in force in Hong Kong, such building or buildings to be completed and made fit for occupation not later than the 31st day of March 2025.”
7. Special Condition No.(4) of the Land Grant stipulates that: -
 “No tree growing on the lot or adjacent thereto shall be removed or interfered with without the prior written consent of the Director who may, in granting consent, impose such conditions as to transplanting, compensatory landscaping or replanting as he may deem appropriate.”
8. Special Condition No.(5)(a) of the Land Grant stipulates that: -
 “The Purchaser shall at his own expense submit to the Director for his approval a landscape plan indicating the location, disposition and layout of the landscaping works to be provided within the lot in compliance with the requirements stipulated in sub-clause (b) of this Special Condition.”
9. Special Condition No.(5)(b) of the Land Grant stipulates that: -
 “(i) Not less than 20% of the area of the lot shall be planted with trees, shrubs or other plants. ...
 (ii) Not less than 50% of the 20% referred to in sub-clause (b)(i) of this Special Condition (hereinafter referred to as “**the Greenery Area**”) shall be provided at such location or level as may be determined by the Director at his sole discretion so that the Greenery Area shall be visible to pedestrians or accessible by any person or persons entering the lot.
 ...”
10. Special Condition No.(5)(c) of the Land Grant stipulates that: -
 “The Purchaser shall at his own expense landscape the lot in accordance with the approved landscape plan in all respects to the satisfaction of the Director, and no amendment, variation, alteration, modification or substitution of the approved landscape plan shall be made without the prior written consent of the Director.”
11. Special Condition No.(5)(d) of the Land Grant stipulates that: -
 “The Purchaser shall thereafter at his own expense maintain and keep the landscaped works in a safe, clean, neat, tidy and healthy condition all to the satisfaction of the Director.”
12. Special Condition No.(6)(a) of the Land Grant stipulates that: -
 “The Purchaser shall at his own expense and in all respects to the satisfaction of the Director lay, form, erect, construct, provide, landscape, uphold, maintain, repair and manage within the lot open space or spaces with a total area of not less than 3,528 square metres (which open space or spaces are hereinafter

referred to as “**the Private Open Space**”) not later than the 31st day of March 2025. The decision of the Director as to what shall be taken into account in the calculation of the total area of the Private Open Space stipulated in this sub-clause (a) shall be final and binding on the Purchaser.”

13. Special Condition No.(6)(b) of the Land Grant stipulates that: -

“The Private Open Space shall not be used for any purpose other than for the proper use and enjoyment of the lot by the residents of the building or buildings erected or to be erected on the lot and their bona fide guests and visitors.”

14. Special Condition No.(6)(c) of the Land Grant stipulates that: -

“No building or structure or support for any building or structure shall be erected or constructed or placed at or above the Private Open Space except with the prior written approval of the Director.”

15. Special Condition No.(9)(a) of the Land Grant stipulates that: -

“The Purchaser shall at his own expense and in all respects to the satisfaction of the Director lay, form erect, construct, provide and landscape within the lot at ground level in a good workmanlike manner, with such materials and to such standards, levels, alignment and design as the Director shall approve and in accordance with the plans approved under sub-clause (c)(i) of this Special Condition a public open space of not less than 3,600 square metres (hereinafter referred to as “**the Public Open Space**”) to be completed and made fit for occupation and operation not later than the 31st day of March 2025 or such other extended date as may be approved by the Director. The Public Open Space shall be located, formed, serviced, landscaped, planted, treated and provided in such manner, with such materials and with such equipment and facilities at the expense of the Purchaser as the Director may require and in all respects to his satisfaction. The decision of the Director as to what constitutes the ground level stipulated in this sub-clause (a) shall be final and binding on the Purchaser. The Purchaser shall, until the Public Open Space shall have been surrendered to the Government in accordance with sub-clause (e)(ii) of this Special Condition, at his own expense uphold, maintain, repair and manage the Public Open Space together with everything thereon in all respects to the satisfaction of the Director.”

16. Special Condition No.(9)(b) of the Land Grant stipulates that: -

“No building or structure or support for any building or structure shall be erected or constructed or placed on, over, above, under, below or within the Public Open Space except such structures as may be required or approved by the Director under sub-clause (c)(i) of this Special Condition.”

17. Special Condition No.(9)(c) of the Land Grant stipulates that: -

“(i) The Purchaser shall at his own expense submit or cause to be submitted to the Director for his written approval plans of the Public Open Space, which shall include details and information as

to the level, position, alignment and design of the Public Open Space and such other details and information as the Director may require.

(ii) No amendment, variation, alteration, modification or substitution to the plans of the Public Open Space approved under sub-clause (c)(i) of this Special Condition shall be made by the Purchaser except with the prior written approval of the Director or except as required by him.

(iii) The plans of the Public Open Space approved under sub-clause (c)(i) of this Special Condition shall be deemed to incorporate any amendment, variation, alteration, modification or substitution subsequently approved or required by the Director under sub-clause (c)(ii) of this Special Condition.”

18. Special Condition No.(9)(d) of the Land Grant stipulates that: -

“In the event of the non-fulfilment of the Purchaser’s obligations under sub-clause (a) of this Special Condition by the date specified therein or such other extended date as may be approved by the Director, the Government may carry out the necessary works at the cost of the Purchaser who shall pay to the Government on demand a sum equal to the cost thereof, such sum to be determined by the Director whose determination shall be final and binding on the Purchaser.”

19. Special Condition No.(9)(e) of the Land Grant stipulates that: -

“Notwithstanding the provisions of Special Conditions Nos. (16) and (19) hereof:

(i) prior to the surrender of the Public Open Space to the Government in accordance with sub-clause (e)(ii) of this Special Condition, the Purchaser shall at his own expense carve out the Public Open Space from the lot by way of a deed poll in such form and containing such provisions as the Director shall approve or require which deed poll shall be registered by the Purchaser at his own expense at the Land Registry and in all respects to the satisfaction of the Director and no transaction (except a building mortgage under Special Condition No.(16)(d) hereof or such other transactions as the Director may approve) affecting the lot or any part thereof or any building or part of any building erected or to be erected thereon shall be entered into prior to such registration; and prior to the carving-out, the Purchaser shall at his own expense submit to the Director for his written approval the deed poll for carving-out the Public Open Space from the lot;

(ii) the Purchaser shall at his own expense prior to compliance with these Conditions in all respects to the satisfaction of the Director or at any time or times when called upon to do so by the Director (whichever is the earlier) surrender and deliver up to the Government vacant possession of the Public Open Space together with such materials, equipment, facilities and structures as may be included in the plans approved by the Director under sub-clause (c)(i) of this Special Condition free from all encumbrances and without any consideration, payment or compensation whatsoever payable by the Government to the Purchaser provided always that the Government shall be under no obligation to accept surrender of the Public Open Space at the request of the Purchaser but may

do so as and when it sees fit and for this purpose, the Purchaser shall at his own expense execute a deed or deeds of surrender and any other necessary documents in such form and containing such provisions as the Director shall approve or require and on such terms and conditions as the Director may require and the Purchaser shall have no right to claim against the Government for any loss, damage or compensation whatsoever directly or indirectly arising out of or in connection with the surrender of the Public Open Space;

- (iii) the Purchaser shall not assign, mortgage, charge, demise, underlet, part with the possession of or otherwise dispose of or encumber the Public Open Space or any part or parts thereof or any interest therein or enter into any agreement so to do provided that this sub-clause (e)(iii) shall not apply to the carving-out of the Public Open Space under sub-clause (e)(i) of this Special Condition, the surrender of the Public Open Space to the Government referred to in sub-clause (e)(ii) of this Special Condition or a building mortgage referred to in Special Condition No.(16)(d) hereof; and
- (iv) the Purchaser agrees and accepts that upon development or redevelopment of the lot or any part thereof, after the surrender of the Public Open Space pursuant to sub-clause (e)(ii) of this Special Condition, due to the reduction in the area of the lot or otherwise, the Purchaser may not be able to attain the maximum gross floor area permitted under Special Condition No.(7)(c) hereof; and the Government shall have no responsibility or liability and the Purchaser shall have no claim for compensation or refund of premium or otherwise whatsoever against the Government, if the maximum gross floor area permitted under Special Condition No.(7)(c) hereof cannot be attained.”

20. Special Condition No.(9)(f) of the Land Grant stipulates that: -

“The Purchaser shall indemnify and keep indemnified the Government and the Director from and against all liabilities, losses, damages, expenses, claims, costs, demands, charges, actions and proceedings of whatsoever nature arising out of or as a consequence of the carrying out, performance or fulfilment of his obligations under this Special Condition.”

21. Special Condition No.(9)(g) of the Land Grant stipulates that: -

“The Director shall have the right at his absolute discretion to nominate representatives (hereinafter referred to as “**the Government Representatives**”) who shall on his behalf monitor and generally oversee the design, erection, construction, provision and completion of the Public Open Space.”

22. Special Condition No.(9)(h) of the Land Grant stipulates that: -

“The Purchaser, his servants, agents, contractors and workmen shall make available all drawings and site records and shall render all necessary assistance and cooperation to the Government Representatives when required by the Government Representatives in relation to their duties under this Special Condition.”

23. Special Condition No.(9)(i) of the Land Grant stipulates that: -

“The Government and the Director shall accept no responsibility or liability for any costs, liabilities, losses, expenses, claims, demands, charges, damages, actions and proceedings of whatsoever nature arising out of or in connection with the exercise by the Government Representatives of their duties under this Special Condition.”

24. Special Condition No.(9)(j) of the Land Grant stipulates that: -

“The Purchaser shall, before surrender of the Public Open Space pursuant to sub-clause (e)(ii) of this Special Condition, permit the Director, his officers, contractors, agents and workmen and any other persons authorized by the Director (including, without limitation, the Government Representatives) with or without tools, equipment, plant, machinery or motor vehicles, the right of free and unrestricted ingress, egress and regress to, from and through the lot or any part thereof and any building or buildings erected or to be erected thereon for the purpose of inspecting, checking and supervising any works to be carried out in accordance with sub-clause (a) of this Special Condition and carrying out any works in accordance with sub-clauses (d) and (p) of this Special Condition or any other works which the Director may consider necessary.”

25. Special Condition No.(9)(k) of the Land Grant stipulates that: -

“Neither the Government nor the Director shall have any responsibility or liability in respect of any loss, damage, nuisance or disturbance whatsoever caused to or suffered by the Purchaser or any other person whether arising out of or incidental to the fulfilment of the Purchaser’s obligations under this Special Condition, the exercise by the Director of the right of entry under sub-clause (j) of this Special Condition or the carrying out of any works under sub-clauses (d) and (p) of this Special Condition and the Purchaser shall not be entitled to any claim whatsoever against the Government or the Director or his authorized officers (including without limitation, the Government Representatives) nor any compensation whatsoever in respect of such loss, damage, nuisance or disturbance.”

26. Special Condition No.(9)(l) of the Land Grant stipulates that: -

“The Purchaser shall as soon as practicable but not later than three calendar months from the date of surrender of the Public Open Space in accordance with sub-clause (e)(ii) of this Special Condition, at his own expense and in all respects to the satisfaction of the Director, provide to the Director free of all costs and charges all documents with detailed specifications, working drawings, catalogues, part lists for all fittings, fixtures and installations and the as-built drawings for the Public Open Space.”

27. Special Condition No.(9)(m) of the Land Grant stipulates that: -

“The Purchaser shall indemnify and keep indemnified the Government against all liabilities, losses, expenses, claims, costs, demands, charges, damages, actions and proceedings of whatsoever nature

arising out of or in connection with any defects, wants of repair, settlements, imperfections, breakdown, faults or any other outstanding works (whether in respect of workmanship, materials, design or otherwise) in the Public Open Space or any part thereof :

- (i) which may exist at the date of surrender by the Purchaser to the Government of the Public Open Space in accordance with sub-clause (e)(ii) of this Special Condition; and
- (ii) which shall occur or become apparent within a period of 365 days from the date of surrender by the Purchaser to the Government of the Public Open Space in accordance with sub-clause (e)(ii) of this Special Condition (which period is hereinafter referred to as **“the Defects Liability Period of the Public Open Space”**).

28. Special Condition No.(9)(n) of the Land Grant stipulates that: -

“Whenever required by the Director or the Government Representatives, the Purchaser shall at his own expense and within such time and to such standard and in such manner as may be specified by the Director or the Government Representatives carry out all works of maintenance, repair, amendment, reconstruction and rectification and any other works as may be necessary to remedy and rectify any defects, wants of repair, settlements, imperfections, breakdown, faults or any other outstanding works in the Public Open Space or any part thereof which shall occur or become apparent within the Defects Liability Period of the Public Open Space. In addition to the foregoing, the Purchaser shall at his own expense and within such time and to such standard and in such manner as may be specified by the Director or the Government Representatives make good and rectify any defects, wants of repair, settlements, imperfections, breakdown, faults or any other outstanding works in the Public Open Space or any part thereof which may exist upon surrender thereof to the Government by the Purchaser.”

29. Special Condition No.(9)(o) of the Land Grant stipulates that: -

“The Director or the Government Representatives will, shortly before the expiry of the Defects Liability Period of the Public Open Space, cause an inspection to be carried out in respect of the Public Open Space or any part thereof for the purpose of identifying any defects, wants of repair, settlements, imperfections, breakdown, faults or any other outstanding works which may be evident. The Director and the Government Representatives reserve the right to each of them to serve upon the Purchaser within fourteen days after the expiry of the Defects Liability Period of the Public Open Space a schedule or schedules of defects specifying any defects, wants of repair, settlements, imperfections, breakdown, faults or any other outstanding works which may be evident in the Public Open Space or any part thereof and the Purchaser shall at his own expense cause all necessary works to be carried out so as to remedy and rectify the same within such time limit and to such standard and in such manner as may be specified by the Director or the Government Representatives.”

30. Special Condition No.(9)(p) of the Land Grant stipulates that: -

“If the Purchaser shall fail to carry out any of the works referred to in sub-clauses (n) and (o) of this

Special Condition, then any such works may be carried out by the Government and all costs and charges incurred in connection therewith by the Government as certified by the Director (whose decision shall be final and binding upon the Purchaser) shall, on demand, be paid by the Purchaser to the Government.”

31. Special Condition No.(9)(q) of the Land Grant stipulates that: -

“For the purpose of calculating the total gross floor area stipulated in Special Condition No.(7)(c) hereof, the Public Open Space shall not be taken into account.”

32. Special Condition No.(9)(r) of the Land Grant stipulates that: -

“For the purpose of this Special Condition, the expression “Purchaser” shall exclude his assigns.”

33. Special Condition No.(10)(a) of the Land Grant stipulates that: -

“The Purchaser shall at his own expense and in all respects to the satisfaction of the Director lay, form, erect, construct, provide and landscape in a good workmanlike manner, with such materials and to such standards, levels, alignment and design as the Director shall approve and in accordance with the plans approved under sub-clause (b)(i) of this Special Condition a waterfront promenade within the areas shown coloured yellow and yellow hatched brown on the plan annexed hereto (hereinafter respectively referred to as **“the Yellow Area”** and **“the Yellow Hatched Brown Area”** and hereinafter collectively referred to as **“the Promenade Area”**), to be completed and made fit for occupation and operation not later than the 31st day of March 2025 or such other extended date as may be approved by the Director. The Purchaser shall, until the Promenade Area shall have been re-delivered to the Government in accordance with sub-clause (f)(ii) of this Special Condition, at his own expense uphold, maintain, repair and manage the Promenade Area together with everything thereon in all respects to the satisfaction of the Director.”

34. Special Condition No.(10)(b) of the Land Grant stipulates that: -

“(i) The Purchaser shall at his own expense submit or cause to be submitted to the Director for his written approval plans of the Promenade Area, which shall include details and information as to the level, position, alignment and design of the Promenade Area and such other details and information as the Director may require.

(ii) No amendment, variation, alteration, modification or substitution to the plans of the Promenade Area approved under sub-clause (b)(i) of this Special Condition shall be made by the Purchaser except with the prior written approval of the Director or except as required by him.

(iii) The plans of the Promenade Area approved under sub-clause (b)(i) of this Special Condition shall be deemed to incorporate any amendment, variation, alteration, modification or substitution subsequently approved or required by the Director under sub-clause (b)(ii) of this Special Condition.

(iv) No building works (other than ground investigation) shall be commenced on or within the Promenade Area or any part thereof unless and until approval of the plans under sub-clause (b)(i) of this Special Condition shall have been obtained.”

35. Special Condition No.(10)(c) of the Land Grant stipulates that: -

“(i) The Purchaser shall not alter, demolish or damage the seawall within the Promenade Area or carry out any works which will adversely affect the seawall or any part or parts thereof and the decision of the Director as to whether any works will adversely affect the seawall shall be final and binding upon the Purchaser.

(ii) The maximum superimposed load within 10 metres from and behind the copeline of the seawall shall not exceed 10 kilonewtons per square metre.

(iii) No form of percussive piling shall be used within 15 metres from the copeline of the seawall.”

36. Special Condition No.(10)(d) of the Land Grant stipulates that: -

“In the event of the non-fulfilment of the Purchaser’s obligations under sub-clause (a) of this Special Condition by the date specified therein or such other extended date as may be approved by the Director, the Government may carry out the necessary works at the cost of the Purchaser who shall pay to the Government on demand a sum equal to the cost thereof, such sum to be determined by the Director whose determination shall be final and binding on the Purchaser.”

37. Special Condition No.(10)(e) of the Land Grant stipulates that: -

“The Government shall have no responsibility or liability in respect of any loss, damage, nuisance or disturbance whatsoever caused to or suffered by the Purchaser or any other persons whether arising out of or incidental to the fulfilment of the Purchaser’s obligations under sub-clause (a) of this Special Condition or the exercise of the rights by the Government under sub-clause (d) of this Special Condition or otherwise, and no claim whatsoever shall be made against the Government by the Purchaser in respect of any such loss, damage, nuisance or disturbance.”

38. Special Condition No.(10)(f) of the Land Grant stipulates that: -

“(i) For the purpose only of carrying out the works specified in sub-clause (a) of this Special Condition, the Purchaser shall :

(I) on the date of this Agreement be deemed to have been granted possession of the Yellow Area; and

(II) on a date or dates to be specified in a letter or letters from the Director to the Purchaser, which date or dates in any event shall not be later than the 31st day of December 2018, be deemed to have been granted possession of the Yellow Hatched Brown Area or any part or parts thereof.

(ii) The Promenade Area shall be re-delivered to the Government by the Purchaser on demand without any payment or compensation to the Purchaser, and in any event shall be deemed to have been re-delivered to the Government by the Purchaser on the date of a letter from the Director indicating that these Conditions have been complied with to his satisfaction.

(iii) The Purchaser shall accept the Yellow Area and the Yellow Hatched Brown Area or any part or parts thereof in such state and condition and with such structures and foundations (if any) as existing on the respective dates on which possession of the Yellow Area and the Yellow Hatched Brown Area or any part or parts thereof is deemed to be given to the Purchaser, and no claim whatsoever shall be made against the Government by the Purchaser in respect thereof.

(iv) The Government shall have no responsibility or liability in respect of any damage, loss, nuisance or disturbance whatsoever caused to or suffered by the Purchaser or any person arising whether directly or indirectly out of or in connection with the provisions of sub-clause (f)(i)(II) of this Special Condition pursuant to which the giving of the possession of the Yellow Hatched Brown Area or any part or parts thereof shall be deferred, and no claim for compensation, refund of premium or otherwise whatsoever shall be made against the Government by the Purchaser in respect of any such damage, loss, nuisance or disturbance.”

39. Special Condition No.(10)(g) of the Land Grant stipulates that: -

“(i) The Purchaser shall at all times prior to the re-delivery of possession of the whole or any part or parts of the Promenade Area :

(I) permit the Government, the Director and his officers, contractors and agents and any other persons authorized by the Director, with or without tools, equipment, plant, machinery or motor vehicles, the right of ingress, egress and regress to, from and through the lot and the Promenade Area for the purpose of inspecting, checking and supervising any works to be carried out in compliance with sub-clause (a) of this Special Condition and the carrying out, inspecting, checking and supervising of the works under sub-clause (d) of this Special Condition and any other works which the Director may consider necessary within the Promenade Area;

(II) permit the Government and the relevant public utility companies authorized by the Government, with or without tools, equipment, plant, machinery or motor vehicles, the right of ingress, egress and regress to, from and through the lot and the Promenade Area as the Government or the relevant public utility companies may require for the purpose of any works to be carried out in, upon or under the Promenade Area or any adjoining land including but not limited to the laying and subsequent maintenance of all pipes, wire,

conduits, cable-ducts and other conducting media and ancillary equipment necessary for the provision of telephone, electricity, gas (if any) and other services intended to serve the lot or any adjoining or neighbouring land or premises, and the Purchaser shall co-operate fully with the Government and also with the relevant public utility companies duly authorized by the Government on all matters relating to any of the aforesaid works to be carried out within the Promenade Area; and

- (III) permit the officers of the Water Authority and such other persons as may be authorized by them, with or without tools, equipment, plant, machinery or motor vehicles, the right of ingress, egress and regress to, from and through the lot and the Promenade Area as the officers of the Water Authority or such authorized persons may require for the purpose of carrying out any works in relation to the operation, maintenance, repairing, replacement and alteration of any waterworks installations within the Promenade Area;
- (ii) The Government, the Director and his officers, contractors, agents and any other persons or public utility companies duly authorized under sub-clause (g)(i) of this Special Condition shall have no responsibility or liability in respect of any loss, damage, nuisance or disturbance whatsoever caused to or suffered by the Purchaser or any other person arising out of or incidental to the exercise of the rights by the Government, the Director and his officers, contractors, agents and any other persons or public utility companies duly authorized under sub-clause (g)(i) of this Special Condition, and no claim whatsoever shall be made by the Purchaser against the Government, the Director and his officers, contractors, agents and any other persons authorized by the Director in respect of any such loss, damage, nuisance or disturbance.”
40. Special Condition No.(10)(h) of the Land Grant stipulates that: -
- “The Purchaser shall indemnify and keep indemnified the Government and the Director from and against all liabilities, losses, damages, expenses, claims, costs, demands, charges, actions and proceedings of whatsoever nature arising out of or as a consequence of the carrying out, performance or fulfilment of his obligations under this Special Condition.”
41. Special Condition No.(10)(i) of the Land Grant stipulates that: -
- “The Director shall have the right at his absolute discretion to nominate representatives (hereinafter referred to as “**the Nominated Representatives**”) who shall on his behalf monitor and generally oversee the design, erection, construction, provision and completion of the Promenade Area.”
42. Special Condition No.(10)(j) of the Land Grant stipulates that: -
- “The Purchaser, his servants, agents, contractors and workmen shall make available all drawings and site records and shall render all necessary assistance and cooperation to the Nominated Representatives when required by the Nominated Representatives in relation to their duties under this Special Condition.”

43. Special Condition No.(10)(k) of the Land Grant stipulates that: -

“The Government and the Director shall accept no responsibility or liability for any liabilities, losses, costs, expenses, claims, demands, charges, damages, actions and proceedings of whatsoever nature arising out of or in connection with the exercise by the Nominated Representatives of their duties under this Special Condition.”

44. Special Condition No.(10)(l) of the Land Grant stipulates that: -

“The Purchaser shall as soon as practicable but not later than three calendar months from the date of re-delivery of the Promenade Area in accordance with sub-clause (f)(ii) of this Special Condition, at his own expense and in all respects to the satisfaction of the Director, provide to the Director free of all costs and charges all documents with detailed specifications, working drawings, catalogues, part lists for all fittings, fixtures and installations and the as-built drawings for the Promenade Area.”

45. Special Condition No.(10)(m) of the Land Grant stipulates that: -

“The Purchaser shall indemnify and keep indemnified the Government against all liabilities, losses, claims, costs, expenses, demands, charges, damages, actions and proceedings of whatsoever nature arising out of or in connection with any defects, wants of repair, settlements, imperfections, breakdown, faults or any other outstanding works (whether in respect of workmanship, materials, design or otherwise) in the Promenade Area or any part thereof.

(i) which may exist at the date of re-delivery by the Purchaser to the Government of the Promenade Area in accordance with sub-clause (f)(ii) of this Special Condition; and

(ii) which shall occur or become apparent within a period of 365 days from the date of re-delivery by the Purchaser to the Government of the Promenade Area in accordance with sub-clause (f)(ii) of this Special Condition (which period is hereinafter referred to as “**the Defects Liability Period of the Promenade Area**”).”

46. Special Condition No.(10)(n) of the Land Grant stipulates that: -

“Whenever required by the Director or the Nominated Representatives, the Purchaser shall at his own expense and within such time and to such standard and in such manner as may be specified by the Director or the Nominated Representatives carry out all works of maintenance, repair, amendment, reconstruction and rectification and any other works as may be necessary to remedy and rectify any defects, wants of repair, settlements, imperfections, breakdown, faults or any other outstanding works in the Promenade Area or any part thereof which shall occur or become apparent within the Defects Liability Period of the Promenade Area. In addition to the foregoing, the Purchaser shall at his own expense and within such time and to such standard and in such manner as may be specified by the Director or the Nominated Representatives make good and rectify any defects, wants of repair, settlements, imperfections, breakdown, faults or any other outstanding works in the Promenade Area or

any part thereof which may exist upon re-delivery thereof to the Government by the Purchaser.”

47. Special Condition No.(10)(o) of the Land Grant stipulates that: -

“The Director or the Nominated Representatives will, shortly before the expiry of the Defects Liability Period of the Promenade Area, cause an inspection to be carried out in respect of the Promenade Area or any part thereof for the purpose of identifying any defects, wants of repair, settlements, imperfections, breakdown, faults or any other outstanding works which may be evident. The Director and the Nominated Representatives reserve the right to each of them to serve upon the Purchaser within fourteen days after the expiry of the Defects Liability Period of the Promenade Area a schedule or schedules of defects specifying any defects, wants of repair, settlements, imperfections, breakdown, faults or any other outstanding works which may be evident in the Promenade Area or any part thereof and the Purchaser shall at his own expense cause all necessary works to be carried out so as to remedy and rectify the same within such time limit and to such standard and in such manner as may be specified by the Director or the Nominated Representatives.”

48. Special Condition No.(10)(p) of the Land Grant stipulates that: -

“If the Purchaser shall fail to carry out any of the works referred to in sub-clauses (n) and (o) of this Special Condition, then any such works may be carried out by the Government and all costs and charges incurred in connection therewith by the Government as certified by the Director (whose decision shall be final and binding upon the Purchaser) shall, on demand, be paid by the Purchaser to the Government.”

49. Special Condition No.(10)(q) of the Land Grant stipulates that: -

“For the purpose of this Special Condition, the expression “Purchaser” shall exclude his assigns.”

50. Special Condition No.(18) of the Land Grant stipulates that: -

“Every assignment, mortgage, charge, underletting for more than three years or other alienation of the lot or any part thereof or any interest therein shall be registered at the Land Registry.”

51. Special Condition No.(20)(b) of the Land Grant stipulates that: -

“Prior to the completion of the construction of the proposed road marked “PROPOSED ROAD” and shown edged by pecked green line for identification purpose on the plan annexed hereto (hereinafter referred to as “**the Proposed Road**”), the Purchaser shall have no right of ingress or egress to or from the lot for the passage of motor vehicles except between such points as the Director shall specify. The Director may, by a notice in writing served upon the Purchaser, inform the Purchaser as to when the construction of the Proposed Road shall have been completed, and the decision of the Director as to when the construction of the Proposed Road shall have been completed shall be final and binding on the Purchaser. The Government shall have no responsibility or liability in respect of any loss, damage,

nuisance or disturbance whatsoever caused to or suffered by the Purchaser or any other person arising out of or incidental to the construction of the Proposed Road and no claim whatsoever shall be made against the Government by the Purchaser in respect of any such loss, damage, nuisance or disturbance.”

52. Special Condition No.(21)(a) of the Land Grant stipulates that: -

“Prior to the completion of the construction of the Proposed Road and subject to Special Condition No.(20)(b) hereof, the lot is granted together with a non-exclusive right for the Purchaser and his servants, visitors, workmen and other persons authorized by the Purchaser in that behalf from time to time and at all times for all purposes connected with the proper use and enjoyment of the lot to pass and re-pass on, along, over, by and through the area shown coloured brown on the plan annexed hereto (hereinafter referred to as “**the Brown Area**”) and the Yellow Hatched Brown Area at such level or levels and alignment or alignments as may be approved by the Director.”

53. Special Condition No.(21)(b) of the Land Grant stipulates that: -

“The Purchaser shall at his own expense uphold, maintain and repair the Brown Area and the Yellow Hatched Brown Area (hereinafter collectively referred to as “**the Right of Way Area**”) and everything forming a portion of or pertaining to it, all to be done to the satisfaction of the Director, and the Purchaser shall be responsible for the whole as if he were the absolute owner thereof.”

54. Special Condition No.(21)(c) of the Land Grant stipulates that: -

“The grant of the right of way referred to in sub-clause (a) of this Special Condition shall not give the Purchaser the exclusive right over the Right of Way Area. The Government shall have the right to grant rights of way over the Right of Way Area to the tenants, lessees and licensees of the neighbouring land or premises now or in the future.”

55. Special Condition No.(21)(d) of the Land Grant stipulates that: -

“In the event of non-fulfilment of the Purchaser’s obligations under sub-clause (b) of this Special Condition, the Government may carry out the necessary works at the cost of the Purchaser who shall pay to the Government on demand a sum equal to the cost thereof, such sum to be determined by the Director whose determination shall be final and binding on the Purchaser.”

56. Special Condition No.(21)(e) of the Land Grant stipulates that: -

“The Government shall have no responsibility or liability in respect of any loss, damage, nuisance or disturbance whatsoever caused to or suffered by the Purchaser or any other person arising out of or incidental to the exercise by the Government of the rights under sub-clause (d) of this Special Condition or otherwise, and no claim whatsoever shall be made against the Government by the Purchaser in respect of any such loss, damage, nuisance or disturbance.”

57. Special Condition No.(21)(f) of the Land Grant stipulates that: -

“Notwithstanding the grant of the right of way referred to in sub-clause (a) of this Special Condition, the Government shall have the full right and power, upon giving to the Purchaser not less than fourteen days’ written notice (save in case of emergency) to lay, install, relay, divert, remove, re-provision, replace, inspect, operate, repair, maintain and renew any Government or other drain, culvert, waterway or watercourse, sewer, nullah, water main, pipe, cable, wire, line, utility service or other works or installations (hereinafter referred to as **“the Right of Way Area Services”**) which are now or may hereafter be upon, over, under or adjacent to the Right of Way Area as the Director may in his absolute discretion deem fit, making good any and all damages caused thereby, and the Government, the Director and his officers, contractors, agents and any persons authorized by the Director, his or their workmen with and without tools, equipment, plant, machinery or motor vehicles shall have the right of free and unrestricted ingress, egress and regress at all times to and from the Right of Way Area for the purposes aforesaid. The Purchaser shall not disturb or allow anybody to disturb the Right of Way Area Services without the prior written approval from the Director. Save in respect of making good any and all damages caused by any exercise of the aforesaid rights and powers, the Government, the Director and his officers, contractors, agents and any persons authorized by the Director, his or their workmen shall have no liability in respect of any loss, damage, nuisance or disturbance whatsoever caused to or suffered by the Purchaser arising out of or incidental to the exercise of the rights conferred under this sub-clause (f), and no claim nor objection whatsoever shall be made against him or them by the Purchaser.”

58. Special Condition No.(21)(g) of the Land Grant stipulates that: -

“For the avoidance of doubt, the grant of the right of way referred to in sub-clause (a) of this Special Condition shall absolutely cease upon the date when the construction of the Proposed Road shall have been completed as stated in the notice served upon the Purchaser under Special Condition No.(20)(b) hereof.”

59. Special Condition No.(22)(a) of the Land Grant stipulates that: -

“(i) Spaces shall be provided within the lot to the satisfaction of the Director for the parking of motor vehicles licensed under the Road Traffic Ordinance, any regulations made thereunder and any amending legislation, and belonging to the residents of the building or buildings erected or to be erected on the lot and their bona fide guests, visitors or invitees (hereinafter referred to as **“the Residential Parking Spaces”**) at the following rates:

...

(iii) Additional spaces shall be provided within the lot to the satisfaction of the Director for the parking of motor vehicles licensed under the Road Traffic Ordinance, any regulations made thereunder and any amending legislation, and belonging to the bona fide guests, visitors or invitees of the residents of the building or buildings erected or to be erected on the lot at the following rates subject to a minimum of five such spaces being provided within the lot:

...

(iv) The spaces provided under sub-clauses (a)(i)(I) and (a)(iii) (as may be respectively varied under Special Condition No.(24) hereof) and (a)(i)(II) of this Special Condition shall not be used for any purpose other than those respectively stipulated therein and in particular the said spaces shall not be used for the storage, display or exhibiting of motor vehicles for sale or otherwise or for the provision of car cleaning and beauty services.”

60. Special Condition No.(22)(b) of the Land Grant stipulates that: -

“(i) Out of the spaces provided under sub-clauses (a)(i)(I) and (a)(iii) of this Special Condition (as may be respectively varied under Special Condition No.(24) hereof), the Purchaser shall reserve and designate such number of spaces for the parking of motor vehicles by disabled persons as defined in the Road Traffic Ordinance, any regulations made thereunder and any amending legislation (which spaces to be so reserved and designated are hereinafter referred to as **“the Parking Spaces for Disabled Persons”**) as the Building Authority may require and approve...

(ii) The Parking Spaces for Disabled Persons shall not be used for any purpose other than for the parking of motor vehicles by disabled persons as defined in the Road Traffic Ordinance, any regulations made thereunder and any amending legislation, and belonging to the residents of the building or buildings erected or to be erected on the lot and their bona fide guests, visitors or invitees and in particular the said spaces shall not be used for the storage, display or exhibiting of motor vehicles for sale or otherwise or for the provision of car cleaning and beauty services.”

61. Special Condition No.(22)(c) of the Land Grant stipulates that: -

“(i) Spaces shall be provided within the lot to the satisfaction of the Director for the parking of motor cycles licensed under the Road Traffic Ordinance, any regulations made thereunder and any amending legislation, and belonging to the residents of the building or buildings erected or to be erected on the lot and their bona fide guests, visitors or invitees (hereinafter referred to as **“the Motor Cycle Parking Spaces”**) ...

(ii) The Motor Cycle Parking Spaces (as may be varied under Special Condition No.(24) hereof) shall not be used for any purpose other than for the purpose set out in sub-clause (c)(i) of this Special Condition and in particular the said spaces shall not be used for the storage, display or exhibiting of motor vehicles for sale or otherwise or for the provision of car cleaning and beauty services.”

62. Special Condition No.(23)(a) of the Land Grant stipulates that: -

“Spaces shall be provided within the lot to the satisfaction of the Director for the loading and unloading of goods vehicles...”

63. Special Condition No.(26)(a) of the Land Grant stipulates that: -

“Notwithstanding that these Conditions shall have been observed and complied with to the satisfaction of the Director, the Residential Parking Spaces and the Motor Cycle Parking Spaces shall not be:

- (i) assigned except:
- (I) together with undivided shares in the lot giving the right of exclusive use and possession of a residential unit or units in the building or buildings erected or to be erected on the lot; or
- (II) to a person who is already the owner of undivided shares in the lot with the right of exclusive use and possession of a residential unit or units in the building or buildings erected or to be erected on the lot; or
- (ii) underlet except to the residents of the residential units in the building or buildings erected or to be erected on the lot

Provided that in any event not more than three in number of the total of the Residential Parking Spaces and the Motor Cycle Parking Spaces shall be assigned to the owner or underlet to the resident of any one residential unit in the building or buildings erected or to be erected on the lot.”

64. Special Condition No.(28) of the Land Grant stipulates that: -

“A plan approved by the Director indicating the layout of all the parking, loading and unloading spaces to be provided within the lot in accordance with Special Conditions Nos.(22) (as may be varied under Special Condition No.(24) hereof) and (23) hereof, or a copy of such plan certified by an Authorized Person (as defined in the Buildings Ordinance, any regulations made thereunder and any amending legislation) shall be deposited with the Director... The parking, loading and unloading spaces indicated on the said approved plan shall not be used for any purpose other than for the purposes set out respectively in Special Conditions Nos.(22) and (23) hereof. The Purchaser shall maintain the parking, loading and unloading spaces and other areas, including but not restricted to the lifts, landings and manoeuvring and circulation areas, in accordance with the said approved plan and shall not alter the layout except with the prior written consent of the Director. Except for the parking spaces indicated on the said approved plan, no part of the lot or any building or structure thereon shall be used for parking purposes.”

65. Special Condition No.(29) of the Land Grant stipulates that: -

“The Purchaser shall not cut away, remove or set back any Government land adjacent to or adjoining the lot or carry out any building-up, filling-in or any slope treatment works of any kind whatsoever on any Government land except with the prior written consent of the Director who may, at his sole discretion, give his consent subject to such terms and conditions as he sees fit, including the grant of additional Government land as an extension to the lot at such premium as he may determine.”

66. Special Condition No.(30)(a) of the Land Grant stipulates that: -

“Where there is or has been any cutting away, removal or setting back of any land, or any building-up or filling-in or any slope treatment works of any kind whatsoever, whether with or without the prior written consent of the Director, either within the lot or on any Government land, which is or was done for the

purpose of or in connection with the formation, levelling or development of the lot or any part thereof or any other works required to be done by the Purchaser under these Conditions, or for any other purpose, the Purchaser shall at his own expense carry out and construct such slope treatment works, retaining walls or other support, protection, drainage or ancillary or other works as shall or may then or at any time thereafter be necessary to protect and support such land within the lot and also any adjacent or adjoining Government or leased land and to obviate and prevent any falling away, landslip or subsidence occurring thereafter. The Purchaser shall at all times during the term hereby agreed to be granted maintain at his own expense the said land, slope treatment works, retaining walls or other support, protection, drainage or ancillary or other works in good and substantial repair and condition to the satisfaction of the Director.”

67. Special Condition No.(30)(c) of the Land Grant stipulates that: -

“In the event that as a result of or arising out of any formation, levelling, development or other works done by the Purchaser or owing to any other reason, any falling away, landslip or subsidence occurs at any time, whether in or from any land within the lot or from any adjacent or adjoining Government or leased land, the Purchaser shall at his own expense reinstate and make good the same to the satisfaction of the Director and shall indemnify the Government, its agents and contractors from and against all costs, charges, damages, demands and claims whatsoever which shall or may be made, suffered or incurred through or by reason of such falling away, landslip or subsidence.”

68. Special Condition No.(30)(d) of the Land Grant stipulates that: -

“In addition to any other rights or remedies herein provided for breach of any of these Conditions, the Director shall be entitled by notice in writing to call upon the Purchaser to carry out, construct and maintain the said land, slope treatment works, retaining walls, or other support, protection, drainage or ancillary or other works or to reinstate and make good any falling away, landslip or subsidence, and if the Purchaser shall neglect or fail to comply with the notice to the satisfaction of the Director within the period specified therein, the Director may forthwith execute and carry out any necessary works and the Purchaser shall on demand repay to the Government the cost thereof, together with any administrative and professional fees and charges.”

69. Special Condition No.(31) of the Land Grant stipulates that: -

“No rock crushing plant shall be permitted on the lot without the prior written approval of the Director.”

70. Special Condition No.(32)(a) of the Land Grant stipulates that: -

“In the event of earth, spoil, debris, construction waste or building materials (hereinafter referred to as “**the waste**”) from the lot, or from other areas affected by any development of the lot being eroded, washed down or dumped onto public lanes or roads or into or onto road-culverts, foreshore or seabed, sewers, storm-water drains or nullahs or other Government properties (hereinafter referred to as “**the Government properties**”), the Purchaser shall at his own expense remove the waste from and make good any damage done to the Government properties. The Purchaser shall indemnify the Government against all actions, claims and demands arising out of any damage or nuisance to private property caused by such erosion, washing down or dumping.”

71. Special Condition No.(33) of the Land Grant stipulates that: -

“The Purchaser shall take or cause to be taken all proper and adequate care, skill and precautions at all times, and particularly when carrying out construction, maintenance, renewal or repair work (hereinafter referred to as **“the Works”**), to avoid causing any damage, disturbance or obstruction to any Government or other existing drain, waterway or watercourse, water main, road, footpath, street furniture, sewer, nullah, pipe, cable, wire, utility service or any other works or installations being or running upon, over, under or adjacent to the lot, the Promenade Area, the Brown Area or any part of any of them (hereinafter collectively referred to as **“the Services”**). The Purchaser shall prior to carrying out any of the Works make or cause to be made such proper search and enquiry as may be necessary to ascertain the present position and levels of the Services, and shall submit his proposals for dealing with any of the Services which may be affected by the Works in writing to the Director for his approval in all respects, and shall not carry out any work whatsoever until the Director shall have given his written approval to the Works and to such aforesaid proposals. The Purchaser shall comply with and at his own expense meet any requirements which may be imposed by the Director in respect of the Services in granting the aforesaid approval, including the cost of any necessary diversion, relaying or reinstatement. The Purchaser shall at his own expense and in all respects repair, make good and reinstate to the satisfaction of the Director any damage, disturbance or obstruction caused to the lot, the Promenade Area, the Brown Area or any part of any of them or any of the Services in any manner arising out of the Works (except for nullah, sewer, storm-water drain or water main, the making good of which shall be carried out by the Director, unless the Director elects otherwise, and the Purchaser shall pay to the Government on demand the cost of such works). If the Purchaser fails to carry out any such necessary diversion, relaying, repairing, making good and reinstatement of the lot, the Promenade Area, the Brown Area or any part of any of them or any of the Services to the satisfaction of the Director, the Director may carry out any such diversion, relaying, repairing, making good or reinstatement as he considers necessary and the Purchaser shall pay to the Government on demand the cost of such works.”

72. Special Condition No.(34)(a) of the Land Grant stipulates that: -

“The Purchaser shall construct and maintain at his own expense and to the satisfaction of the Director such drains and channels, whether within the boundaries of the lot or on Government land, as the Director may consider necessary to intercept and convey into the nearest stream-course, catchpit, channel or Government storm-water drain all storm-water or rain-water falling or flowing on to the lot, and the Purchaser shall be solely liable for and shall indemnify the Government and its officers from and against all actions, claims and demands arising out of any damage or nuisance caused by such storm-water or rain-water.”

73. Special Condition No.(34)(b) of the Land Grant stipulates that: -

“The works of connecting any drains and sewers from the lot to the Government storm-water drains and sewers, when laid and commissioned, may be carried out by the Director who shall not be liable to the Purchaser for any loss or damage thereby occasioned and the Purchaser shall pay to the Government on demand the cost of such connection works. Alternatively, the said connection works may be carried out by the Purchaser at his own expense and to the satisfaction of the Director and in such case any

section of the said connection works which is constructed within Government land shall be maintained by the Purchaser at his own cost and upon demand be handed over by the Purchaser to the Government for future maintenance thereof at the expense of the Government and the Purchaser shall pay to the Government on demand the cost of the technical audit in respect of the said connection works. The Director may, upon failure of the Purchaser to maintain any section of the said connection works which is constructed within Government land, carry out such maintenance works as he considers necessary and the Purchaser shall pay to the Government on demand the cost of such works.”

74. Special Condition No.(35)(a) of the Land Grant stipulates that: -

“(i) No building or structure or support for any building or structure shall be erected or constructed or placed on, over, above, under, below or within the areas of drainage reserve shown coloured pink stippled black and marked “DR” on the plan annexed hereto (hereinafter referred to as **“the Drainage Reserve Areas”**).

...”

75. Special Condition No.(35)(b) of the Land Grant stipulates that: -

“The Government, the Director and his duly authorized officers, agents, contractors, his or their workmen (hereinafter collectively referred to as **“the Relevant Persons”**) with or without tools, equipment, plant, machinery or motor vehicles shall have the right of unrestricted ingress, egress and regress at all times to, from and through the lot for the purposes of laying, inspecting, repairing and maintaining drains, sewers, channels, drainage facilities and all other services running across, through or under the Drainage Reserve Areas (hereinafter collectively referred to as **“the Utilities”**) which the Director may require or authorize. No object or material of whatsoever nature which may obstruct access or cause excessive surcharge to the Utilities shall be placed within the Drainage Reserve Areas. Where in the opinion of the Director (whose opinion shall be final and binding on the Purchaser), there is object or material within the Drainage Reserve Areas which may obstruct access or cause excessive surcharge to the Utilities, the Director shall be entitled by notice in writing to call upon the Purchaser, at his own expense and in all respects to the satisfaction of the Director, to remove or demolish such object or material and to reinstate the Drainage Reserve Areas. If the Purchaser shall neglect or fail to comply with such notice within the time limit specified therein or as required in an emergency, the Director may carry out such removal, demolition and reinstatement works as he may consider necessary and the Purchaser shall pay to the Government on demand the cost of such works.”

76. Special Condition No.(36) of the Land Grant stipulates that: -

“ With the prior written consent of the Director, the Purchaser may erect or construct noise barrier or noise barriers on the lot with projection extending beyond the boundary of the lot and over and above any portion of the adjoining Government land (hereinafter referred to as **“the Noise Barrier”**) subject to the following conditions:

- (a) the Purchaser shall at his own expense design, erect and construct the Noise Barrier in accordance with the plans approved by the Building Authority and in all respects in compliance with the Buildings Ordinance, any regulations made thereunder and any amending legislation;
- (b) no foundation or support for the Noise Barrier may be erected on, upon or underneath any Government land adjoining the lot;
- (c) no alteration, addition, replacement or attachment whatsoever shall be made or affixed to or upon the Noise Barrier or any part or parts thereof except with the prior written approval of the Director;
- (d) the Purchaser shall at all times and at his own expense uphold, maintain and repair the Noise Barrier or (where approved by the Director) any replacement thereof in good and substantial repair and condition in all respects to the satisfaction of the Director; and if temporary traffic closure or diversion shall be required for carrying out any works under this sub-clause (d), written agreement of the Commissioner for Transport on the temporary traffic arrangement shall have been obtained before commencement of any works;
- (e) the Noise Barrier shall not be used for any purpose other than for noise barrier and the Purchaser shall not use or suffer or allow to be used the Noise Barrier or any part or parts thereof for advertising or for the display of any signs, notices or posters whatsoever except with the prior written consent of the Director;
- (f) subject to the prior written approval of the Director, the Purchaser and his contractors, workmen or any other persons authorized by the Purchaser shall be permitted to enter into the Government land adjoining the lot with or without tools, equipment, plant, machinery or motor vehicles for the purposes of carrying out any erection, construction, inspection, repair, maintenance, cleaning, renewal and replacement of the part or parts of the Noise Barrier projecting over the Government land in accordance with this Special Condition;
- (g) the Government shall have no responsibility or liability for any loss, damage, nuisance or disturbance whatsoever caused to or suffered by the Purchaser or any other person whether arising directly or indirectly out of or incidental to their entry or carrying out of the works referred to in sub-clause (f) of this Special Condition and no claim whatsoever shall be made against the Government in respect of any such loss, damage, nuisance or disturbance;
- (h) the Purchaser shall at all times take such precautions as may be necessary to prevent any damage or injury being caused to any Government land adjoining the lot and the Noise Barrier or to any persons or vehicles entering or using any Government land adjoining the lot and the Noise Barrier as a result of the erection, construction, inspection, repair, maintenance, cleaning, alteration, renewal, replacement, use, demolition or removal of the Noise Barrier;
- (i) the Director shall, at any time and at his absolute discretion, have the right to serve upon the Purchaser a written notice requiring the Purchaser to demolish and remove the part or parts of the Noise Barrier that project over the Government land without any replacement within six calendar months from the date of the written notice; and upon receipt of such written notice, the Purchaser shall at his own expense demolish and remove the aforesaid part or parts of the Noise Barrier within such period as stipulated in such written notice and in all respects to the satisfaction of the Director;
- (j) in the event of the non-fulfillment of any of the Purchaser's obligations under this Special Condition, the Director may carry out the necessary works and the Purchaser shall pay to the Director on demand the cost of such works;
- (k) the Purchaser shall, at all times throughout the term hereby agreed to be granted, permit the Director, his officers, contractors, agents and workmen and any other persons authorized by the Director with or without tools, equipment, plant, machinery or motor vehicles, the right of free and unrestricted ingress, egress and regress to, from and through the lot or any part thereof and any building or buildings erected or to be erected thereon for the purpose of inspecting, checking and supervising any works to be carried out in accordance with sub-clauses (a), (d) and (i) of this Special Condition and carrying out any works in accordance with sub-clause (j) of this Special Condition or any other works which the Director may consider necessary;
- (l) neither the Government nor the Director shall have any responsibility or liability in respect of any loss, damage, nuisance or disturbance whatsoever caused to or suffered by the Purchaser or any other person whether arising out of or incidental to the fulfillment of the Purchaser's obligations under this Special Condition, the exercise by the Director of the right of entry under sub-clause (k) of this Special Condition or the carrying out of any works under sub-clause (j) of this Special Condition and the Purchaser shall not be entitled to any claim whatsoever against the Government or the Director or his authorized officers nor any compensation whatsoever in respect of such loss, damage, nuisance or disturbance; and
- (m) the Purchaser shall at all times indemnify and keep indemnified the Government, the Director and his officers, contractors, agents and workmen and any other persons authorized by the Director under sub-clause (k) of this Special Condition from and against all liabilities, losses, damages, expenses, claims, costs, charges, demands, actions and proceedings whatsoever arising whether directly or indirectly out of or in connection with the erection, construction, presence, repair, maintenance, alteration, renewal, replacement, use, demolition or removal of the Noise Barrier or in connection with the works under sub-clause (j) of this Special Condition."

77. Special Condition No.(37) of the Land Grant stipulates that: -

“Wherever in these Conditions it is provided that:

- (a) the Government or its duly authorized officers shall or may carry out works of any description on the lot or any part thereof or outside the lot (whether on behalf of the Purchaser or on the failure of the Purchaser to carry out such works or otherwise) at the cost of the Purchaser or that the Purchaser shall pay or repay to the Government or to its duly authorized officers on demand the cost of such works, such cost shall include such supervisory and overhead charges as may be fixed by the Government or by its duly authorized officers; or

...”

78. Special Condition No.(39) of the Land Grant stipulates that: -

“No grave or columbarium shall be erected or made on the lot, nor shall any human remains or animal remains whether in earthenware jars, cinerary urns or otherwise be interred therein or deposited thereon.”

Notes:

1. Pursuant to Special Condition No.(9)(a) of the Land Grant, the Public Open Space has been carved out from New Kowloon Inland Lot No.6549 under the Deed Poll registered in the Land Registry by Memorial No.20060900670017. It does not form part of the Lot on which the Development is situated, and will be maintained by the Vendor prior to its surrender to the Government.
2. The expression “Purchaser” under the Land Grant, where the context so admits or requires, includes his executors, administrators and assigns and in case of a corporation its successors and assigns.
3. Please refer to the Land Grant for full details. A copy of the Land Grant is available for inspection free of charge during opening hours at the sales office upon request and copies will be provided on payment of photocopying charges.

1. 發展項目興建於按日期為2017年12月15日的賣地條件第20313號 (經日期為2020年8月26日的延期信函修訂) (「**批地文件**」)而持有的新九龍內地段第6549號餘段 (「**該地段**」)。
2. 該地段批地年期由2017年12月15日起計50年。
3. 批地文件特別條件第(3)條訂明：

「該地段或其任何部分或該處任何已建或擬建建築物或建築物任何部分除作私人住宅用途外，不可作任何其他用途。」
4. 批地文件一般條件第(7)(a)條訂明：

「買方應在整個批地年期的期間內遵照此等批地條件進行建造或重建(本詞指本一般條件(b)分條擬建的重建工程)：

 - (i) 依照經批核的設計和布局及任何核准建築圖則(不得作任何更改或修改)維修所有建築物；及
 - (ii) 維修現已或此後將會遵照此等批地條件或日後任何合約修訂條文建造的所有建築物，以保持其修繕妥當及狀況良好，並且在批地年期屆滿或提前終止時以同等的維修及狀態交還此等建築物。」
5. 批地文件一般條件第(7)(b)條訂明：

「如該地段或其任何部分的現有建築物於批地年期內任何時間拆卸，買方必須另建穩固良好的一座或多座同類型建築物而樓面總面積不少於現有建築物或類型和價值經署長批核的一座或多座建築物作替代。倘如上所述拆卸建築物，買方應在拆卸前一個曆月內向署長申請同意在該地段進行重建工程及於買方接獲同意書後，必須在三個曆月內展開必要的重建工程，並在署長指定的期限內以署長滿意的方式完成重建。」
6. 批地文件特別條件第(2)條訂明：

「買方應發展該地段，即全面遵照此等批地條件和任何時間於香港生效的所有建築、衛生及規劃條例、附例與規例，在該處建造一座或多座建築物。上述的一座或多座建築物應在2025年3月31日或之前建成並適宜佔用居住。」
7. 批地文件特別條件第(4)條訂明：

「如事前未獲署長書面同意，而署長給予同意時可附加其視為恰當的移植、補償園景或再植條件，概不可移除或干預任何現於該地段或毗連土地生長的樹木。」
8. 批地文件特別條件第(5)(a)條訂明：

「買方應自費向署長提交園景設計圖，述明遵照本特別條件(b)分條在該地段進行園景工程的位置、規劃和布局，以供署長審批。」
9. 批地文件特別條件第(5)(b)條訂明：

「(i) 該地段須有不少於20%的面積種植樹木、灌叢或其他植物…

(ii) 本特別條件(b)(i)分條所載的20%面積中，須有不少於50%(以下簡稱「**綠化地方**」)應設於署長全權酌情指定的位置或樓層，以致任何行人可看見或進入該地段的人士或人等均可通行綠化地方。

…」
10. 批地文件特別條件第(5)(c)條訂明：

「買方應自費按照經批核的園景設計圖，以署長全面滿意的方式在該地段進行園景工程。如事前未獲署長書面同意，不得修改、更改、改動、改變或取代經批核的園景設計圖。」
11. 批地文件特別條件第(5)(d)條訂明：

「其後買方應自費保養和維修園景工程，以維持其安全、清潔、整齊、井然和健康的狀態，以全面令署長滿意。」
12. 批地文件特別條件第(6)(a)條訂明：

「買方應在2025年3月31日或之前自費以署長全面滿意的方式，於該地段鋪設、拓建、興建、建造、提供、園景美化、保養、維修、修理及管理總面積不少於3,528平方米的休憩用地(此等休憩用地以下簡稱「**私人休憩用地**」)。署長就甚麼將計入本(a)分條所訂私人休憩用地總面積作出的決定將作終論，並對買方有約束力。」
13. 批地文件特別條件第(6)(b)條訂明：

「私人休憩用地除供該地段任何已建或擬建的一座或多座建築物的住戶和彼等各真正賓客及訪客正當使用與共享外，不可作任何其他用途。」
14. 批地文件特別條件第(6)(c)條訂明：

「如事前未獲署長書面同意，不得在私人休憩用地之上或在其範圍內搭建或建造任何建築物、構築物或其支撐物。」

15. 批地文件特別條件第(9)(a)條訂明：

「買方應自費以署長全面滿意的方式，以良好工藝採用署長批准的物料、標準、水平、定線和設計，以及依照已遵從本特別條件(c)(i)分條規定審批的圖則，在該地段地面層鋪設、拓建、興建、建造、提供及園景美化一個面積不少於3,600平方米的公眾休憩用地(以下簡稱「**公眾休憩用地**」)，並於2025年3月31日或之前或於署長批准的延長限期內建成並適宜佔用和運作。公眾休憩用地應由買方自費採用署長指定的方式、物料、設備及設施、選址、拓建、保養、園景美化、種植花木、處理和提供，以全面令署長滿意。署長就何謂本(a)分條所指地面層所作的決定將作終論，並對買方有約束力。直至公眾休憩用地遵照本特別條件(e)(ii)分條規定交還政府為止，買方須自費保養、維修、修理和管理公眾休憩用地連同該處的所有物件，以全面令署長滿意。」

16. 批地文件特別條件第(9)(b)條訂明：

「不得在公眾休憩用地之上、跨越其上或其下或在其範圍內搭建、建造或放置任何建築物、構築物或其支撐物，惟署長根據本特別條件(c)(i)分條指定或批准的構築物除外。」

17. 批地文件特別條件第(9)(c)條訂明：

- (i) 買方應自費向署長提交或達致向署長提交公眾休憩用地的圖則，以便署長書面審批。圖則應涵蓋公眾休憩用地的水平、位置、定線及設計的詳情和資料，以及署長要求的其他詳情和資料。
- (ii) 公眾休憩用地圖則根據本特別條件(c)(i)分條批核後，買方如事前未獲署長書面批准或經署長指定，概不得作出修改、更改、修訂、改動或取代。
- (iii) 根據本特別條件(c)(i)分條批核的公眾休憩用地圖則將被視作已納入署長其後根據本特別條件(c)(ii)分條批准或指定的任何修改、更改、修訂、改動或取代內容。」

18. 批地文件特別條件第(9)(d)條訂明：

「倘買方不在本特別條件第(9)(a)條訂明的日期或署長批准的其他延長期限內履行該條訂明的責任，政府可執行必要的工程，費用由買方支付。買方須在政府通知時支付有關的費用，付款金額由署長釐定，其決定將作終論，並對買方有約束力。」

19. 批地文件特別條件第(9)(e)條訂明：

「儘管有本文特別條件第(16)及(19)條之規定：

- (i) 公眾休憩用地按照本特別條件(e)(ii)分條交還政府之前，買方應自費簽訂署長指定或批准格式和條文的分割契約，以從該地段分割公眾休憩用地。買方應自費於土地註冊處註冊分

割契約，以全面令署長滿意。如上辦妥註冊之前，不可進行任何涉及該地段或其任何部分或該處已建或擬建建築物或建築物任何部分的交易(本特別條件第(16)(d)條訂明的建築按揭或署長批准的其他交易除外)。於分割公眾休憩用地之前，買方應自費向署長提交將公眾休憩用地從該地段分割的分割契約，以供署長書面批核；

- (ii) 買方以署長全面滿意的方式履行此等批地條件之前，又或在署長通知時(二者取其較早時間)，買方應自費以交吉形式向政府交還和騰空交回公眾休憩用地，連同署長根據本特別條件(c)(i)分條審批的圖則註明之物料、設備、設施及構築物，不得有任何留置權，而政府亦毋須向買方支付任何代價、款項或彌償。然而，政府概無責任必須按照買方要求收回公眾休憩用地，政府可按其視為恰當收回有關的土地。買方須就此遵照署長規定的條款與條件，自費訂立一份或多份土地交還契約和署長批准或指定格式和條文的任何其他必要文件。買方概無權基於交還公眾休憩用地而直接或間接引起或導致之損失、損害或補償向政府索償；
- (iii) 買方不可轉讓、按揭、押記、讓予、分租、出讓或以其他方式處置或抵押公眾休憩用地或其任何一個或多個部分或當中任何權益，或就此訂立任何協議。惟本(e)(iii)分條並不適用於按照本特別條件(e)(i)分條分割公眾休憩用地、依照本特別條件(e)(ii)分條規定向政府交還公眾休憩用地或本文特別條件第(16)(d)條訂明的建築按揭；及
- (iv) 買方同意及接納，公眾休憩用地根據本特別條件(e)(ii)分條交回政府後，買方發展或重建該地段或其任何部分時可能因為該地段面積縮減等理由而無法取得本文特別條件第(7)(c)條訂明的最大樓面總面積。倘無法取得本文特別條件第(7)(c)條訂明的最大樓面總面積，政府概無任何義務或責任，而買方不可向政府申索賠償或退還地價等。」

20. 批地文件特別條件第(9)(f)條訂明：

「倘因買方進行、執行或履行本特別條件訂明的責任導致或引起任何性質的責任、損失、損害、開支、索償、費用、訴求、收費、訴訟及法律程序，買方須向政府及署長作出賠償並確保彼等免責。」

21. 批地文件特別條件第(9)(g)條訂明：

「署長可全權酌情指定代表(以下簡稱「**政府代表**」)，以代表署長監察及一般地統籌設計、興建、建造、提供和建成公眾休憩用地。」

22. 批地文件特別條件第(9)(h)條訂明：

「買方、其傭工、代理、承辦商和工人均須在政府代表通知時提供所有與本特別條件訂明其應履行職責相關的圖則及工地記錄，並要提供所有必要協助和合作。」

23. 批地文件特別條件第(9)(i)條訂明：

「倘因政府代表行使本特別條件訂明的職責招致或引起任何性質的費用、責任、損失、開支、索償、訴求、收費、損害、訴訟及法律程序，政府及署長概不承擔任何義務或責任。」

24. 批地文件特別條件第(9)(j)條訂明：

「於公眾休憩用地根據本特別條件(e)(ii)分條交還政府之前，買方必須允許署長、其人員、承辦商、代理、工人及署長授權的任何其他人等(包括但不限於政府代表)行使權利，不論攜帶工具、設備、機器、機械或駕車與否，自由及不受限制地通行、進出、往返及行經該地段或其任何部分和該處任何已建或擬建的一座或多座建築物，以便檢查、檢驗及監督任何遵照本特別條件(a)分條執行的工程，以及按照本特別條件(d)及(p)分條規定執行任何工程或署長認為有必要實施的任何其他工程。」

25. 批地文件特別條件第(9)(k)條訂明：

「倘因為或鑒於買方履行本特別條件訂明的責任，或因署長行使本特別條件(j)分條訂明的進入權，又或執行本特別條件(d)及(p)分條所載的任何工程，導致或連帶引致買方或任何其他人士招致或蒙受任何損失、損害、滋擾或騷擾，政府或署長概毋須承擔任何義務或責任。買方無權對政府、署長或其授權人員(包括但不限於政府代表)提出任何索償，亦不會就此等損失、損害、滋擾或騷擾獲得任何彌償。」

26. 批地文件特別條件第(9)(l)條訂明：

「買方應盡早而最遲於公眾休憩用地依照本特別條件(e)(ii)分條交還後三個曆月內，自費以署長全面滿意的方式，完全免費地向署長提供公眾休憩用地的所有文件連同詳細規格、工作圖則、目錄、所有配件、固定裝置及裝設的零件清單和竣工記錄圖。」

27. 批地文件特別條件第(9)(m)條訂明：

「倘公眾休憩用地或其任何部分有任何不良缺點、失修、沉降、不善、失靈、故障或任何其他未完成工程(不論關乎工藝、質料或設計等)，而於：

(i) 買方遵照本特別條件(e)(ii)分條規定將公眾休憩用地交還政府當日現存；及

(ii) 買方遵照本特別條件(e)(ii)分條規定將公眾休憩用地交還政府當日後365日內的期間(以下簡稱「**公眾休憩用地保修期**」)出現或可見，

買方將就由此引致或招致的任何性質之責任、損失、開支、索償、費用、訴求、收費、損害、訴訟及法律程序向政府作出賠償並確保其免責。」

28. 批地文件特別條件第(9)(n)條訂明：

「只要署長或政府代表要求，買方須自費按照署長或政府代表指定的期限、標準和方式執行所有必要的維修、修理、更改、重建、補救及任何其他工程，以補救及糾正公眾休憩用地或其任何部分於公眾休憩用地保修期內出現或可見的不良缺點、失修、沉降、不善、失靈、故障或任何其他未完成工程。買方除要遵從前文的規定外，並須自費按照署長或政府代表指定的期限、標準及方式修復和糾正在買方向政府交還公眾休憩用地或其任何部分當日已存在的任何不良缺點、失修、沉降、不善、失靈、故障或任何其他未完成工程。」

29. 批地文件特別條件第(9)(o)條訂明：

「署長或政府代表將於公眾休憩用地保修期即將屆滿時達致派員檢驗公眾休憩用地或其任何部分，以查看是否發現任何不良缺點、失修、沉降、不善、失靈、故障或任何其他未完成工程。署長及政府代表保留權利於公眾休憩用地保修期完結後十四天內向買方發出保修列表，列明公眾休憩用地或其任何部分的任何不良缺點、失修、沉降、不善、失靈、故障或任何其他未完成工程，買方應自費依照署長或政府代表指定的期限、標準和方式達致執行所有必要工程，以作修葺和糾正。」

30. 批地文件特別條件第(9)(p)條訂明：

「如買方不執行本特別條件(n)及(o)分條列明的任何工程，政府可自行執行此等工程，買方須在接獲通知時向政府支付政府由此招致而經署長核實(其決定將作終論並對買方有約束力)的所有費用及收費。」

31. 批地文件特別條件第(9)(q)條訂明：

「遵照本文特別條件第(7)(c)條計算所有樓面總面積時，公眾休憩用地不會連計在內。」

32. 批地文件特別條件第(9)(r)條訂明：

「就本特別條件而言，「買方」一詞的釋義並不包括其受讓人。」

33. 批地文件特別條件第(10)(a)條訂明：

「買方應自費以署長全面滿意的方式，以良好工藝採用署長批准的物料、標準、水平、定線和設計，以及依照已遵從本特別條件(b)(i)分條規定審批的圖則，在本文所夾附圖則以黃色、黃色間棕色斜線顯示的範圍(以下分別簡稱「**黃色範圍**」、「**黃色間棕色斜線範圍**」並統稱「**海濱廣場範圍**」)鋪設、拓建、興建、建造、提供和園景美化一個海旁海濱廣場，並於2025年3月31日或之前或於署長批准的延長期限內建成並適宜佔用和運作。直至海濱廣場範圍按照本特別條件(f)(ii)分條交還政府為止，買方須自費以署長全面滿意的方式保養、維修、修理和管理海濱廣場範圍連同該處的所有物件。」

34. 批地文件特別條件第(10)(b)條訂明：

- 「(i) 買方應自費向署長提交或達致向署長提交海濱廣場範圍的圖則，以便署長書面審批。圖則應涵蓋海濱廣場範圍的水平、位置、定線及設計的詳情和資料，以及署長要求的其他詳情和資料。
- (ii) 海濱廣場範圍圖則根據本特別條件(b)(i)分條批核後，買方如事前未獲署長書面批准又或經署長指定，概不得作出修改、更改、修訂、改動或取代。
- (iii) 根據本特別條件(b)(i)分條批核的海濱廣場範圍圖則將視作已納入署長其後根據本特別條件第(b)(ii)分條批准或指定的任何修改、更改、修訂、改動或取代內容。
- (iv) 除非及直至圖則已遵照本特別條件(b)(i)分條獲得批核，否則不得在海濱廣場範圍或其任何部分之上或之內展開任何建築工程(土地勘測工程除外)。」

35. 批地文件特別條件第(10)(c)條訂明：

- 「(i) 買方不可更改、拆卸或損壞海濱廣場範圍內的海堤，或進行任何會對海堤或其任何一個或多個部分構成不良影響的工程。署長就何等工程會對海堤構成不良影響所作的決定將作終論，並對買方有約束力。
- (ii) 海堤蓋頂線對開及後方10米範圍內的最大附加承重負荷不可超過每平方米10千牛頓。
- (iii) 海堤蓋頂線15米範圍內不得進行任何形式的撞擊式打樁工程。」

36. 批地文件特別條件第(10)(d)條訂明：

「倘買方不在本特別條件(a)分條指定的日期或署長批准的其他延長期限內履行該條訂明的責任，政府可執行必要的工程，費用由買方支付。買方須在政府通知時支付有關的費用，付款金額由署長釐定，其決定將作終論，並對買方有約束力。」

37. 批地文件特別條件第(10)(e)條訂明：

「如因買方履行本特別條件(a)分條所訂責任，或因政府行使本特別條件(d)分條訂明的權利等，導致或連帶引致買方或任何其他人士招致或蒙受任何損失、損害、滋擾或騷擾，政府概不承擔任何義務或責任，買方不可就任何此等損失、損害、滋擾或騷擾向政府提出索償。」

38. 批地文件特別條件第(10)(f)條訂明：

「(i) 茲為執行本特別條件(a)分條所訂的工程，買方將：

- (I) 於本協議訂立日獲授予黃色範圍的佔管權；及
 - (II) 被視作已於署長發函指定的一個或多個日期獲授予黃色間棕色斜線範圍或其任何一個或多個部分的佔管權。惟上述日期不可遲逾2018年12月31日。
- (ii) 買方應在接獲通知時將海濱廣場範圍交還政府，政府不會向買方支付任何款項或彌償，而於任何情況下海濱廣場範圍亦會被視為於署長發函說明買方已以其滿意的方式全面履行此等批地條件當日交還政府。
 - (iii) 買方將全面接納黃色範圍及黃色間棕色斜線範圍或其任何一個或多個部分的狀態和情況，以及在買方已分別被視作取得黃色範圍及黃色間棕色斜線範圍或其任何一個或多個部分佔管權當日現存的構築物和地基(如有)。買方不得就此向政府提出任何索償。
 - (iv) 倘因有本特別條件(f)(i)(II)分條之規定而導致延遲移交黃色間棕色斜線範圍或其任何一個或多個部分的佔管權，從而直接或間接造成或致使買方或任何人士招致或蒙受任何損害、損失、滋擾或騷擾，政府概不承擔任何義務或責任，買方不可就任何此等損害、損失、滋擾或騷擾向政府索取賠償或要求退回地價等。」

39. 批地文件特別條件第(10)(g)條訂明：

「(i) 買方交還海濱廣場範圍整體或其任何一個或多個部分佔管權之前，時刻均須：

- (I) 允許政府、署長、其人員、承辦商、代理及署長授權的任何其他人等，不論攜帶工具、設備、機器、機械或駕車與否，行使權利通行、進出、往返和行經該地段及海濱廣場範圍，以便檢查、檢驗及監督任何遵照本特別條件(a)分條執行的工程，以及執行、檢查、檢驗和監督任何遵照本特別條件(d)分條規定的工程及署長認為有必要在海濱廣場範圍實施的任何其他工程。
- (II) 允許政府及政府授權的相關公用事業公司行使權利，不論攜帶工具、設備、機器、機械或駕車與否，按彼等需要通行、進出、往返和行經該地段及海濱廣場範圍，以便於海濱廣場範圍或任何毗連土地之內、其上或其下執行工程，包括但不限於鋪設及其後維修所有水管、電線、管線、電纜管道和其他導體及附屬設備，以便提供擬供該地段或任何毗連或毗鄰土地或處所使用的電話、電力、燃氣(如有)及其他服務。買方應與政府和政府授權的相關公用事業公司充分合作，以處理所有關乎在海濱廣場範圍內執行任何上述工程的事項；及
- (III) 允許水務監督人員及彼等授權的其他人等行使權利，不論攜帶工具、設備、機器、機械或駕車與否，按水務監督人員及彼等授權人士需要通行、進出、往返和行經該地段及海濱廣場範圍，以執行任何關於運作、維修、修理、更換及更改海濱廣場範圍內任何其他水務裝置的工程；

- (ii) 倘因政府、署長及其人員、承辦商及代理和任何其他人士等或根據本特別條件(g)(i)分條正式獲授權的公用事業公司行使權利，導致或連帶引致買方或任何其他人士招致或蒙受任何損失、損害、滋擾或騷擾，政府、署長及其人員、承辦商及代理和任何其他人士等或根據本特別條件(g)(i)分條正式獲授權的公用事業公司概毋須就此承擔任何義務或責任，買方不得就任何此等損失、損害、滋擾或騷擾向政府、署長及其人員、承辦商、代理和任何其他獲署長授權人等索償。」

40. 批地文件特別條件第(10)(h)條訂明：

「倘因買方進行、執行或履行本特別條件所訂的責任而導致或引起任何性質的責任、損失、損害、開支、索償、費用、訴求、收費、訴訟及法律程序，買方須向政府及署長作出賠償並確保彼等免責。」

41. 批地文件特別條件第(10)(i)條訂明：

「署長可全權酌情指定代表(以下簡稱「**指定代表**」)，以代表署長監察及一般地統籌設計、興建、建造、提供和建成海濱廣場範圍。」

42. 批地文件特別條件第(10)(j)條訂明：

「買方、其傭工、代理、承辦商和工人均須在指定代表通知時提供所有與本特別條件訂明其應履行職責相關的圖則及工地記錄，並要提供所有必要協助和合作。」

43. 批地文件特別條件第(10)(k)條訂明：

「倘因指定代表行使本特別條件訂明的職責招致或引起任何性質的責任、損失、費用、開支、索償、訴求、收費、損害、訴訟及法律程序，政府及署長概不承擔任何義務或責任。」

44. 批地文件特別條件第(10)(l)條訂明：

「買方應盡早而最遲於海濱廣場範圍依照本特別條件(f)(ii)分條交還後三個曆月內，自費以署長全面滿意的方式，完全免費地向署長提供海濱廣場範圍的所有文件連同詳細規格、工作圖則、目錄、所有配件、固定裝置及裝設的零件清單和竣工記錄圖。」

45. 批地文件特別條件第(10)(m)條訂明：

「倘海濱廣場範圍或其任何部分有任何不良缺點、失修、沉降、不善、失靈、故障或任何其他未完成工程(不論關乎工藝、質料、設計等)，而於：

- (i) 買方遵照本特別條件(f)(ii)分條規定將海濱廣場範圍交還政府當日現存；及

- (ii) 買方遵照本特別條件(f)(ii)分條規定將海濱廣場範圍交還政府當日後365日內的期間(以下簡稱「**海濱廣場範圍保修期**」)出現或可見，

買方將就由此引致或招致的任何性質之責任、損失、索償、費用、開支、訴求、收費、損害、訴訟及法律程序向政府作出賠償並確保其免責。」

46. 批地文件特別條件第(10)(n)條訂明：

「只要署長或指定代表要求，買方須自費按照署長或指定代表指定的期限、標準和方式執行所有必要的維修、修理、更改、重建、補救及任何其他工程，以補救及糾正海濱廣場範圍或其任何部分於海濱廣場範圍保修期內出現或可見的不良缺點、失修、沉降、不善、失靈、故障或任何其他未完成工程。買方除要遵從前文的規定外，並須自費按照署長或指定代表指定的期限、標準及方式修復和糾正在買方向政府交還海濱廣場範圍或其任何部分當日已存在的任何不良缺點、失修、沉降、不善、失靈、故障或任何其他未完成工程。」

47. 批地文件特別條件第(10)(o)條訂明：

「署長或指定代表將於海濱廣場範圍保修期即將屆滿時達致派員檢驗海濱廣場範圍或其任何部分，以查看是否發現任何不良缺點、失修、沉降、不善、失靈、故障或任何其他未完成工程。署長及指定代表保留權利於海濱廣場範圍保修期完結後十四天內向買方發出保修列表，列明海濱廣場範圍或其任何部分的任何不良缺點、失修、沉降、不善、失靈、故障或任何其他未完成工程，買方應自費依照署長或指定代表指定的期限、標準和方式達致執行所有必要工程，以作修葺和糾正。」

48. 批地文件特別條件第(10)(p)條訂明：

「如買方不執行本特別條件(n)及(o)分條列明的任何工程，政府可自行執行此等工程，買方須在接獲通知時向政府支付政府由此招致而經署長核實(其決定將作終論並對買方有約束力)的所有費用及收費。」

49. 批地文件特別條件第(10)(q)條訂明：

「就本特別條件而言，「買方」一詞的釋義並不包括其受讓人。」

50. 批地文件特別條件第(18)條訂明：

「該地段或其任何部分或權益每次轉讓、按揭、押記、分租超過三年或作任何其他讓與交易，必須在土地註冊處註冊。」

51. 批地文件特別條件第(20)(b)條訂明：

「現於本文所夾圖則以綠色虛線網邊識別並註明為“PROPOSED ROAD”的擬建道路(以下簡稱「**擬建道路**」)建成之前，除往來署長指定的各點外，買方無權通行、進出或往返該地段作車輛通道。署長可向買方發出書面通知，說明擬建道路將於何時建成，而署長就擬建道路將於何時建成所作的決定將作終論，並對買方有約束力。倘因建築擬建道路導致或連帶引致買方或任何其他人士招致或蒙受任何損失、損害、滋擾或騷擾，政府概毋須承擔任何義務或責任，買方不得就此等損失、損害、滋擾或騷擾向政府索償。」

52. 批地文件特別條件第(21)(a)條訂明：

「在擬建道路建成之前，並且遵從本文特別條件第(20)(b)條之規定，該地段乃連同一項非專有權利批授，買方及其傭工、訪客、工人和買方就此授權的其他人等均可不時及時刻為完善使用與享用該地段的所有相關目的，依照署長批准的水平及走線通行、行經、經過、進出和往返現於本文所夾圖則以棕色顯示的範圍(以下簡稱「**棕色範圍**」)及黃色間棕色斜線範圍。」

53. 批地文件特別條件第(21)(b)條訂明：

「買方應自費以署長全面滿意的方式保養、維修和修理棕色範圍及黃色間棕色斜線範圍(以下統稱「**通道權範圍**」)，以及所有附屬或從屬該處的物件，並且就其整體範圍承擔責任，猶如買方絕對擁有此等範圍。」

54. 批地文件特別條件第(21)(c)條訂明：

「本特別條件(a)分條所載授予的通行權概不賦予買方通道權範圍的專有權利，政府有權於現時或日後向毗鄰土地或處所的租客、租戶及受許可人授予通道權範圍的通行權。」

55. 批地文件特別條件第(21)(d)條訂明：

「倘買方不履行本特別條件(b)分條訂明的責任，政府可執行必要的工程，費用由買方支付。買方須在政府通知時支付有關的費用，付款金額由署長釐定，而其決定將作終論，並對買方有約束力。」

56. 批地文件特別條件第(21)(e)條訂明：

「倘因政府行使本特別條件(d)分條所訂權利導致或連帶引致買方或任何其他人士招致或蒙受任何損失、損害、滋擾或騷擾，政府概毋須承擔任何義務或責任，買方不得就此等損失、損害、滋擾或騷擾向政府索償。」

57. 批地文件特別條件第(21)(f)條訂明：

「儘管已授予本特別條件(a)分條所載的通行權，政府仍有全權和權力，在向買方發出不少於十四天書面通知(緊急情況除外)後，按署長全權酌情認為恰當地，進行鋪設、安裝、重鋪、改道、拆卸、重置、更換、檢查、運作、修理、維修及更新現時或及後位於通道權範圍之上、跨越或其下或毗連該處的任何政府或其他排水渠、暗渠、水道或水路、污水管、明渠、總喉、水管、電纜、電線、管線、公用服務或其他工程或裝置(以下簡稱「**通道權範圍服務設施**」)，如工程造成任何損壞則妥為修葺。政府、署長及其人員、承辦商、代理和署長授權的任何人等或彼等之工人有權為着上述事宜，隨時不論攜帶工具、設備、機器、機械或駕車與否，自由及不受限制地通行、進出及往返通道權範圍。買方如事前未獲署長書面批准，不得干擾或允許他人干擾通道權範圍服務設施。除非因行使上述權利及權力造成任何損害必須負責修復外，政府、署長及其人員、承辦商、代理和署長授權的任何人等或彼等之工人概毋須就行使本(f)分條所訂權利而導致或連帶引致買方所招致或蒙受的任何損失、損害、滋擾或騷擾承擔責任，買方不得向彼等任何一方提出索償或異議。」

58. 批地文件特別條件第(21)(g)條訂明：

「為免生疑問，根據本文特別條件第(20)(b)條向買方發出通知書說明擬建道路已建成當日，本特別條件(a)分條所述授予的通行權將絕對終止。」

59. 批地文件特別條件第(22)(a)條訂明：

(i) 該地段內應提供署長滿意的車位，以供該地段任何已建或擬建的一座或多座建築物的住戶及彼等各真正賓客、訪客或獲邀人士停泊彼等擁有並依據《道路交通條例》、其任何附屬規例及相關修訂法例持牌的車輛(以下簡稱「**住宅車位**」)，配置比例如下：

...

(ii) 該地段內應額外提供署長滿意的車位，以供該地段任何已建或擬建的一座或多座建築物的住戶之各真正賓客、訪客或獲邀人士停泊彼等擁有並依據《道路交通條例》、其任何附屬規例及相關修訂法例持牌的車輛，配置比例如下，而該地段最少須設有五(5)個此等車位：

...

(iii) 遵照本特別條件(a)(i)(I)及(a)(iii)分條(可遵照本文特別條件第(24)條規定調整)和(a)(i)(II)分條提供的車位，除作其分別訂明的用途外，不可作任何其他用途，其中特別禁止在車位存放、陳列或展示車輛作招售等用途或提供洗車及汽車美容服務。」

60. 批地文件特別條件第(22)(b)條訂明：

- 「(i) 買方應依照建築事務監督指定和批准，從遵照本特別條件(a)(i)(I)及(a)(iii)分條設置的車位中(可遵照本文特別條件第(24)條規定調整)預留及劃出一定數目的車位，以供符合《道路交通條例》、其任何附屬規例及相關修訂法例定義的傷殘人士停泊車輛(此等預留及指定車位以下簡稱「傷殘人士車位」) …
- (ii) 傷殘人士車位除供符合《道路交通條例》、其任何附屬規例及相關修訂法例定義的傷殘人士停泊屬於該地段任何已建或擬建的一座或多座建築物的住戶及彼等各真正賓客、訪客或獲邀人士的車輛外，不可作任何其他用途，其中特別禁止在車位存放、陳列或展示車輛作招售等用途或提供洗車及汽車美容服務。」

61. 批地文件特別條件第(22)(c)條訂明：

- 「(i) 該地段內應提供署長滿意的車位，以供該地段任何已建或擬建的一座或多座建築物的住戶及彼等各真正賓客、訪客或獲邀人士停泊彼等擁有並依據《道路交通條例》、其任何附屬規例及相關修訂法例持牌的電單車(以下簡稱「電單車車位」) …
- (ii) 電單車車位(可遵照本文特別條件第(24)條規定調整)除作本特別條件(c)(i)分條訂明的用途外，不可作任何其他用途，其中特別禁止在車位存放、陳列或展示車輛作招售等用途或提供洗車及汽車美容服務。」

62. 批地文件特別條件第(23)(a)條訂明：

「該地段應設有署長滿意的車位供上落貨車使用…」

63. 批地文件特別條件第(26)(a)條訂明：

「儘管買方已履行和遵守此等批地條件以令署長滿意，住宅車位及電單車車位不可：

- (i) 轉讓，除非：
- (I) 連同賦予專有權使用和佔用該地段任何已建或擬建的一座或多座建築物內的一個或多個住宅單位之不分割份數一併轉讓；或
- (II) 承讓人現時已擁有具專有權使用和佔管該地段任何已建或擬建的一座或多座建築物內的一個或多個住宅單位之不分割份數；或

(ii) 分租(租予該地段任何已建或擬建的一座或多座建築物內的住宅單位之住戶除外)。

於任何情況下，該地段任何已建或擬建的一座或多座建築物內的任何一個住宅單位之業主或住戶，概不可承讓或承租多於三個住宅車位及電單車車位。」

64. 批地文件特別條件第(28)條訂明：

「買方須向署長提交一份經署長批核並且列明將會按照本文特別條件第(22)條(可根據本文特別條件第(24)條調整)及第(23)條於該地段範圍內提供所有車位及上落貨車位的布局圖則，或經認可人士(釋義以《建築物條例》、其任何附屬規例及相關修訂法例所訂為準)核證的圖則。… 上述核准圖則載明的車位及上落貨車位除作本文特別條件第(22)及(23)條分別訂明的用途外，不可作任何其他用途。買方應遵照上述核准圖則維修車位及上落貨車位和其他地方，包括但不限於電梯、樓梯平台和運轉及循環區域。除非事前獲署長書面同意，否則不可更改布局圖。除上述核准圖則註明的車位外，該地段或該處任何建築物或構築物均不可作泊車用途。」

65. 批地文件特別條件第(29)條訂明：

「如事前未獲署長書面同意，買方不得在毗鄰或毗連該地段的任何政府土地進行削土、移土或土地後移工程，或進行任何建造、填土或斜坡處理工程，而署長給予同意時可全權酌情附加其視為恰當的任何條款與條件，包括收取署長指定的地價後額外批出政府土地作為該地段的增批地段。」

66. 批地文件特別條件第(30)(a)條訂明：

「如該地段或任何政府土地現時或以往曾經配合或因應該地段或其任何部分的構建、平整或發展事宜進行削土、移土或土地後移工程，或進行任何建造或填土工程或斜坡處理工程，或此等批地條件等規定買方執行的其他工程，不論事前是否獲署長書面同意，買方亦須在當時或及後任何時間，按需要自費進行和建造斜坡處理工程、護土牆或其他支承結構、防護結構、排水或輔助或其他工程，以保護和支撐該地段內的土地及任何毗連或毗鄰政府土地或已批租土地，同時避免及防止其後發生滑土、山泥傾瀉或地陷。買方應在本文協定的整個批租年期內自費維修上述土地、斜坡處理工程、護土牆或其他支承結構、防護結構、排水或附屬或其他工程，以保持其修繕妥當及狀況良好，令署長滿意。」

67. 批地文件特別條件第(30)(c)條訂明：

「無論何時，如因買方進行構建、平整、發展或其他工程或因其他事故導致或引起該地段內的土地或任何毗連或毗鄰政府土地或已批租土地發生滑土、山泥傾瀉或地陷，買方須自費還原並修葺該處，以令署長滿意，同時就政府、其代理及承辦商因此等滑土、山泥傾瀉或地陷而蒙受或招致的所有費用、收費、損害、索求及索償作出賠償，並確保彼等免責。」

68. 批地文件特別條件第(30)(d)條訂明：

「除享有本文訂明可就違反此等批地條件追討之任何其他權利或補償權外，署長另有權向買方發出書面通知，要求買方進行、建造和維修上述的土地、斜坡處理工程、護土牆或其他支承結構、防護結構、排水或輔助或其他工程，又或還原並修葺任何滑土、山泥傾瀉或地陷範圍。如買方在該通知書訂明的期限內，疏忽或不執行通知書的指示，以達致署長滿意，署長可即時執行及進行任何必要的工程，買方必須在接獲通知時向政府償還有關的費用，以及任何行政及專業費用與收費。」

69. 批地文件特別條件第(31)條訂明：

「如事前未獲署長書面批准，不准在該地段範圍內使用碎石機。」

70. 批地文件特別條件第(32)(a)條訂明：

「如源自該地段或受該地段發展項目影響的其他地方之廢土、泥石、瓦礫、建築廢物或建材(以下簡稱「**廢物**」)侵蝕、沖流或棄置於公共小巷或道路，又或排進道路下水道、前濱或海床、污水管、雨水渠或明渠或其他政府產業(以下簡稱「**政府產業**」)，買方必須自費清理廢物和修復受損的政府產業，此外並須就廢物侵蝕、沖流或棄置而導致私人物業蒙受損害或滋擾所引致的所有訴訟、索償及訴求向政府賠償。」

71. 批地文件特別條件第(33)條訂明：

買方時刻均須謹慎地採取或達致採取所有完善及適當的謹慎、工藝和預防措施，其中尤以任何建造、維修、更新或修理工程(以下統稱「**工程**」)施工期間為要，藉以避免損壞、干擾或阻塞位於、跨越其上、在其下或毗鄰該地段、海濱廣場範圍、棕色範圍或其任何部分的政府或其他現有排水渠、水道或水路、總喉、道路、行人道、街道設施、污水管、明渠、水管、電纜、電線、公用服務設施或任何其他工程或裝置(以下統稱「**服務設施**」)。買方執行任何此等工程之前，必須進行或達致進行完善調查和查詢，以核實服務設施的現況及水平位置，並須以書面向署長提交處理任何可能受工程影響的服務設施之建議書以待全面審批。直至署長以書面批准工程及上述建議書為止，買方不得展開任何工程。買方應遵從及自費履行署長給予上述批准時就服務設施制訂的規定，包括作出任何必要改道、重鋪或還原工程的費用。買方須自費以署長全面滿意的方式修理、修復和還原工程(明渠、污水管、雨水渠或總喉例外，除非署長另行決定，否則此等渠道應由署長修復，而買方須在政府通知時支付有關費用)導致或引起該地段、海濱廣場範圍、棕色範圍或其任何部分或任何服務設施所蒙受的損害、干擾或阻塞。如買方不在該地段、海濱廣場範圍、棕色範圍或其任何部分或任何服務設施執行此等必要的改道、重鋪、修理、修復及還原工程以令署長滿意，署長可按其視為必要執行此等改道、重鋪、修理、還原或修復工程，買方須在政府通知時支付有關的費用。」

72. 批地文件特別條件第(34)(a)條訂明：

「買方應按署長視為需要，自費以署長滿意的方式在該地段邊界範圍內或政府土地上建造和維修排水渠及渠道，以截流及輸送所有落下或流進該地段的暴雨水或雨水至最鄰近的河溪、集水井、渠道或政府雨水渠。倘此等暴雨水或雨水造成任何損害或滋擾以致引起任何訴訟、索償及訴求，買方必須承擔全責並向政府及其人員作出賠償。」

73. 批地文件特別條件第(34)(b)條訂明：

「接駁該地段任何排水渠及污水管至已鋪設及啟用之政府雨水渠和污水管的工程可由署長負責執行，署長毋須就由此引致的任何損失或損害向買方承擔責任，而買方接獲政府通知時須向政府支付此等接駁工程的費用。此外，買方亦可自費以署長滿意的方式執行上述接駁工程。於該情況下，位於政府土地範圍內的上述接駁工程部分將由買方自費維修，如政府發出通知，買方須將此等工程部分移交政府，日後由政府自費維修，買方並須在政府通知時向政府繳付上述接駁工程的技術審核費用。如買方不維修建於政府土地上的上述接駁工程任何部分，署長可執行其視為必要的維修工程，買方須在政府通知時支付有關工程的費用。」

74. 批地文件特別條件第(35)(a)條訂明：

「(i) 不可在現於本文所夾附圖則以粉紅色加黑點顯示並註明為“DR”的渠務專用區域(以下簡稱「**渠務專用範圍**」)之上、跨越其上、其下或之內興建、建造或放置任何建築物、構築物或建築物或構築物的支撐物。

...」

75. 批地文件特別條件第(35)(b)條訂明：

「政府、署長及其正式授權的人員、代理、承辦商或彼等的工人(以下統稱「**相關人等**」)現獲賦予權利，不論攜帶工具、設備、機器、機械或駕車與否，在任何時間均可不受限制地通行、進出、往返和行經該地段，以便鋪設、檢查、修理及維修橫貫、穿越渠務專用範圍或位於其下的排水渠、污水渠、渠道、排水設施及署長指定或批准的所有其他服務設施(以下統稱「**公用服務設施**」)。渠務專用範圍內不可放置任何可能阻礙出入或招致公用服務設施超出負荷的物件或物料。如署長認為(其意見將作終論並對買方有約束力)渠務專用範圍內存在可能阻礙出入或招致公用服務設施超出負荷的物件或物料，署長有權以書面通知買方自費移走或清拆此等物件或物料並還原渠務專用範圍，以令署長全面滿意。倘買方疏忽不執行或未於通知書訂明的期限內執行規定，又或發生緊急事故，署長可自行實施其視為必要的移走、清拆及還原工程，買方須在接獲通知時向政府支付此等工程的費用。」

76. 批地文件特別條件第(36)條訂明：

「如事前獲署長書面同意，買方可於該地段上興建或建造任何伸展至該地段邊界以外並跨越毗鄰政府土地的一個或多個隔音屏障(以下統稱「**隔音屏障**」)，但必須遵從以下條件：

- (a) 買方應自費依照建築事務監督批核的圖則及全面遵照《建築物條例》、其任何附屬規例及相關修訂法例的規定設計、興建和建造隔音屏障；
- (b) 不可在毗鄰該地段的任何政府土地之上、之內或其下興建隔音屏障的地基或支撐物；
- (c) 如事前未獲署長書面批准，不可在隔音屏障或其任何一個或多個部分進行或安裝改建、加建、更換或附件工程；
- (d) 買方時刻均須自費保養、維修和修理隔音屏障或(如署長批准)其任何更換，以保持其修繕妥當及狀況良好，全面令署長滿意。如執行本(d)分條的工作需要暫時禁止車輛通行或改道，必須在施工前取得運輸署署長以書面同意臨時交通安排；
- (e) 隔音屏障除作隔音屏障外，不可作任何其他用途。如事前未獲署長書面同意，買方不可使用或容忍、准許他人使用隔音屏障或其任何一個或多個部分作陳列廣告或展示任何招牌、告示或海報用途；
- (f) 如事前獲署長書面批准，買方、其承辦商、工人或買方授權的任何其他人等可獲准不論攜帶工具、設備、機器、機械或駕車與否，進入毗鄰該地段的政府土地，以便遵照本特別條件興建、建造、檢查、修理、維修、清潔、更新和更換伸展至跨越政府土地的隔音屏障部分；
- (g) 倘因執行本特別條件(f)分條所載的工程而直接或間接令買方或任何其他人士招致或蒙受任何損失、損害、滋擾或騷擾，政府概不承擔任何義務或責任，買方不得就任何此等損失、損害、滋擾或騷擾向政府索償；
- (h) 買方時刻均須採取必要的預防措施，防止因為興建、建造、檢查、修理、維修、清潔、更改、更新、更換、使用、拆卸或清拆隔音屏障而導致毗鄰該地段之政府土地及隔音屏障或任何進入或使用毗鄰該地段政府土地及隔音屏障的人士或車輛損壞或受損；
- (i) 署長可隨時全權酌情行使權利，向買方發出書面通知，要求買方在接獲通知書後六個曆月內拆卸及清拆跨越政府土地的隔音屏障任何一個或多個部分。買方接獲通知書後，應在通知書列明的期限內自費以署長全面滿意的方式拆卸及清拆上述的隔音屏障部分；
- (j) 如買方不履行本特別條件所訂的買方責任，署長可執行必要的工程，買方須在接獲署長通知時支付有關的工程費用；
- (k) 在本文協定批授的整個年期內，買方時刻均須允許署長、其人員、承辦商、代理、工人及署長授權的任何其他人等，不論攜帶工具、設備、機器、機械或駕車與否，行使權力自由及不受限制地通行、進出、往返和行經該地段或其任何部分及該地段任何已建或擬建的一座或多座建築物，以便檢查、檢驗和監督任何遵照本特別條件(a)、(d)及(i)分條執行的任何工程，以及任何遵照本特別條件第(j)分條執行的工程和署長認為有必要實施的任何其他工程；
- (l) 倘因買方履行本特別條件訂明的責任，或因署長行使本特別條件(k)分條所訂的進入權，又或因執行本特別條件(j)分條訂明的工程導致或連帶引致買方或任何其他人士招致或蒙受任何損失、損害、滋擾或騷擾，政府或署長概不承擔任何義務或責任，買方不得就任何此等損失、損害、滋擾或騷擾向政府、署長或其授權人員索償；及
- (m) 倘鑒於隔音屏障的興建、建造、存在、修理、維修、更改、更新、更換、使用、拆卸或清拆工程，或因執行本特別條件(j)分條訂明的工程而直接或間接導致或引起任何責任、損失、損害、開支、索償、費用、收費、訴求、訴訟和其他法律程序，買方須隨時向政府、署長及其人員、承辦商、代理、工人及署長根據本特別條件(k)分條授權的任何人士作出賠償並確保彼等免責。」

77. 批地文件特別條件第(37)條訂明：

「只要任何此等批地條件規定：

- (a) 政府或其正式授權的人員均應或均可於該地段或其任何部分或於該地段外執行任何性質的工程(不論乃代表買方或因買方不執行此等工程等)，費用由買方支付，又或買方在接獲通知時向政府或其正式授權的人員償付工程費用。工程費用應包括政府或其正式授權的人員釐定之督導及間接費用；或

…」

78. 批地文件特別條件第(39)條訂明：

「該地段不可搭建或建造任何墳墓或骨灰龕，亦不可安葬或放置任何人類或動物遺體，不論屬陶泥、金塔或骨灰盅等。」

附註：

1. 根據批地文件特別條件第(9)(a)條，公眾休憩用地已由土地註冊處註冊摘要編號為20060900670017的分割契據從新九龍內地段第6549號中被分割出來。公眾休憩用地並不構成發展項目所在該地段的一部分，並會在交還給政府前由賣方維持。
2. 批地文件中「買方」一詞，如上下文意允許或規定，包括其遺產執行人、遺產管理人及受讓人，如屬公司則包括其繼承人及受讓人。
3. 欲悉詳情請參考批地文件。批地文件全文已備於售樓處，歡迎在開放時間免費閱覽，並可支付費用索取影印副本。

A. Facilities that are required under the Land Grant to be constructed and provided for the Government, or for public use

1. Public Open Space as referred to in Special Condition No.(9) of the Land Grant

(1) Relevant provisions of the Land Grant that concern the above facilities:

Special Condition No.(9) of the Land Grant (as varied or modified by an extension letter dated 26th August 2020) stipulates that: -

- “(a) The Purchaser shall at his own expense and in all respects to the satisfaction of the Director lay, form erect, construct, provide and landscape within the lot at ground level in a good workmanlike manner, with such materials and to such standards, levels, alignment and design as the Director shall approve and in accordance with the plans approved under sub-clause (c)(i) of this Special Condition a public open space of not less than 3,600 square metres (hereinafter referred to as **“the Public Open Space”**) to be completed and made fit for occupation and operation not later than the 31st day of March 2025 or such other extended date as may be approved by the Director. The Public Open Space shall be located, formed, serviced, landscaped, planted, treated and provided in such manner, with such materials and with such equipment and facilities at the expense of the Purchaser as the Director may require and in all respects to his satisfaction. The decision of the Director as to what constitutes the ground level stipulated in this sub-clause (a) shall be final and binding on the Purchaser. The Purchaser shall, until the Public Open Space shall have been surrendered to the Government in accordance with sub-clause (e)(ii) of this Special Condition, at his own expense uphold, maintain, repair and manage the Public Open Space together with everything thereon in all respects to the satisfaction of the Director.
- (b) No building or structure or support for any building or structure shall be erected or constructed or placed on, over, above, under, below or within the Public Open Space except such structures as may be required or approved by the Director under sub-clause (c)(i) of this Special Condition.
- (c)(i) The Purchaser shall at his own expense submit or cause to be submitted to the Director for his written approval plans of the Public Open Space, which shall include details and information as to the level, position, alignment and design of the Public Open Space and such other details and information as the Director may require.
- (c)(ii) No amendment, variation, alteration, modification or substitution to the plans of the Public Open Space approved under sub-clause (c)(i) of this Special Condition shall be made by the Purchaser except with the prior written approval of the Director or except as required by him.
- (c)(iii) The plans of the Public Open Space approved under sub-clause (c)(i) of this Special

Condition shall be deemed to incorporate any amendment, variation, alteration, modification or substitution subsequently approved or required by the Director under sub-clause (c)(ii) of this Special Condition.

- (d) In the event of the non-fulfilment of the Purchaser’s obligations under sub-clause (a) of this Special Condition by the date specified therein or such other extended date as may be approved by the Director, the Government may carry out the necessary works at the cost of the Purchaser who shall pay to the Government on demand a sum equal to the cost thereof, such sum to be determined by the Director whose determination shall be final and binding on the Purchaser.
- (e) Notwithstanding the provisions of Special Conditions Nos. (16) and (19) hereof:
- (i) prior to the surrender of the Public Open Space to the Government in accordance with sub-clause (e)(ii) of this Special Condition, the Purchaser shall at his own expense carve out the Public Open Space from the lot by way of a deed poll in such form and containing such provisions as the Director shall approve or require which deed poll shall be registered by the Purchaser at his own expense at the Land Registry and in all respects to the satisfaction of the Director and no transaction (except a building mortgage under Special Condition No.(16)(d) hereof or such other transactions as the Director may approve) affecting the lot or any part thereof or any building or part of any building erected or to be erected thereon shall be entered into prior to such registration; and prior to the carving-out, the Purchaser shall at his own expense submit to the Director for his written approval the deed poll for carving-out the Public Open Space from the lot;
- (ii) the Purchaser shall at his own expense prior to compliance with these Conditions in all respects to the satisfaction of the Director or at any time or times when called upon to do so by the Director (whichever is the earlier) surrender and deliver up to the Government vacant possession of the Public Open Space together with such materials, equipment, facilities and structures as may be included in the plans approved by the Director under sub-clause (c)(i) of this Special Condition free from all encumbrances and without any consideration, payment or compensation whatsoever payable by the Government to the Purchaser provided always that the Government shall be under no obligation to accept surrender of the Public Open Space at the request of the Purchaser but may do so as and when it sees fit and for this purpose, the Purchaser shall at his own expense execute a deed or deeds of surrender and any other necessary documents in such form and containing such provisions as the Director shall approve or require and on such terms and conditions as the Director may require and the Purchaser shall have no right to claim against the Government for any loss, damage or compensation whatsoever directly or indirectly arising out of or in connection with the surrender of the Public Open Space;
- (iii) the Purchaser shall not assign, mortgage, charge, demise, underlet, part with the possession of or otherwise dispose of or encumber the Public Open Space or any part

- or parts thereof or any interest therein or enter into any agreement so to do provided that this sub-clause (e)(iii) shall not apply to the carving-out of the Public Open Space under sub-clause (e)(i) of this Special Condition, the surrender of the Public Open Space to the Government referred to in sub-clause (e)(ii) of this Special Condition or a building mortgage referred to in Special Condition No.(16)(d) hereof; and
- (iv) the Purchaser agrees and accepts that upon development or redevelopment of the lot or any part thereof, after the surrender of the Public Open Space pursuant to sub-clause (e)(ii) of this Special Condition, due to the reduction in the area of the lot or otherwise, the Purchaser may not be able to attain the maximum gross floor area permitted under Special Condition No.(7)(c) hereof; and the Government shall have no responsibility or liability and the Purchaser shall have no claim for compensation or refund of premium or otherwise whatsoever against the Government, if the maximum gross floor area permitted under Special Condition No.(7)(c) hereof cannot be attained.
- (f) The Purchaser shall indemnify and keep indemnified the Government and the Director from and against all liabilities, losses, damages, expenses, claims, costs, demands, charges, actions and proceedings of whatsoever nature arising out of or as a consequence of the carrying out, performance or fulfilment of his obligations under this Special Condition.
- (g) The Director shall have the right at his absolute discretion to nominate representatives (hereinafter referred to as “**the Government Representatives**”) who shall on his behalf monitor and generally oversee the design, erection, construction, provision and completion of the Public Open Space.
- (h) The Purchaser, his servants, agents, contractors and workmen shall make available all drawings and site records and shall render all necessary assistance and cooperation to the Government Representatives when required by the Government Representatives in relation to their duties under this Special Condition.
- (i) The Government and the Director shall accept no responsibility or liability for any costs, liabilities, losses, expenses, claims, demands, charges, damages, actions and proceedings of whatsoever nature arising out of or in connection with the exercise by the Government Representatives of their duties under this Special Condition.
- (j) The Purchaser shall, before surrender of the Public Open Space pursuant to sub-clause (e)(ii) of this Special Condition, permit the Director, his officers, contractors, agents and workmen and any other persons authorized by the Director (including, without limitation, the Government Representatives) with or without tools, equipment, plant, machinery or motor vehicles, the right of free and unrestricted ingress, egress and regress to, from and through the lot or any part thereof and any building or buildings erected or to be erected thereon for the purpose of inspecting, checking and supervising any works to be carried out in accordance with sub-clause (a) of this Special Condition and carrying out any works in accordance with sub-clauses (d) and (p) of this Special Condition or any other works which the Director may consider necessary.
- (k) Neither the Government nor the Director shall have any responsibility or liability in respect of any loss, damage, nuisance or disturbance whatsoever caused to or suffered by the Purchaser or any other person whether arising out of or incidental to the fulfilment of the Purchaser’s obligations under this Special Condition, the exercise by the Director of the right of entry under sub-clause (j) of this Special Condition or the carrying out of any works under sub-clauses (d) and (p) of this Special Condition and the Purchaser shall not be entitled to any claim whatsoever against the Government or the Director or his authorized officers (including without limitation, the Government Representatives) nor any compensation whatsoever in respect of such loss, damage, nuisance or disturbance.
- (l) The Purchaser shall as soon as practicable but not later than three calendar months from the date of surrender of the Public Open Space in accordance with sub-clause (e)(ii) of this Special Condition, at his own expense and in all respects to the satisfaction of the Director, provide to the Director free of all costs and charges all documents with detailed specifications, working drawings, catalogues, part lists for all fittings, fixtures and installations and the as-built drawings for the Public Open Space.
- (m) The Purchaser shall indemnify and keep indemnified the Government against all liabilities, losses, expenses, claims, costs, demands, charges, damages, actions and proceedings of whatsoever nature arising out of or in connection with any defects, wants of repair, settlements, imperfections, breakdown, faults or any other outstanding works (whether in respect of workmanship, materials, design or otherwise) in the Public Open Space or any part thereof :
- (i) which may exist at the date of surrender by the Purchaser to the Government of the Public Open Space in accordance with sub-clause (e)(ii) of this Special Condition; and
- (ii) which shall occur or become apparent within a period of 365 days from the date of surrender by the Purchaser to the Government of the Public Open Space in accordance with sub-clause (e)(ii) of this Special Condition (which period is hereinafter referred to as “**the Defects Liability Period of the Public Open Space**”).
- (n) Whenever required by the Director or the Government Representatives, the Purchaser shall at his own expense and within such time and to such standard and in such manner as may be specified by the Director or the Government Representatives carry out all works of maintenance, repair, amendment, reconstruction and rectification and any other works as may be necessary to remedy and rectify any defects, wants of repair, settlements, imperfections, breakdown, faults or any other outstanding works in the Public Open Space or any part thereof which shall occur or become apparent within the Defects Liability Period of the Public Open Space. In addition to the foregoing, the Purchaser shall at his own expense and within such time and to such standard and in such manner as may be specified by the Director or the Government Representatives make good and rectify any defects, wants of repair, settlements, imperfections, breakdown, faults or any other outstanding works in the Public Open Space or any part thereof which may exist upon surrender thereof to the Government by the Purchaser.

- (o) The Director or the Government Representatives will, shortly before the expiry of the Defects Liability Period of the Public Open Space, cause an inspection to be carried out in respect of the Public Open Space or any part thereof for the purpose of identifying any defects, wants of repair, settlements, imperfections, breakdown, faults or any other outstanding works which may be evident. The Director and the Government Representatives reserve the right to each of them to serve upon the Purchaser within fourteen days after the expiry of the Defects Liability Period of the Public Open Space a schedule or schedules of defects specifying any defects, wants of repair, settlements, imperfections, breakdown, faults or any other outstanding works which may be evident in the Public Open Space or any part thereof and the Purchaser shall at his own expense cause all necessary works to be carried out so as to remedy and rectify the same within such time limit and to such standard and in such manner as may be specified by the Director or the Government Representatives.
- (p) If the Purchaser shall fail to carry out any of the works referred to in sub-clauses (n) and (o) of this Special Condition, then any such works may be carried out by the Government and all costs and charges incurred in connection therewith by the Government as certified by the Director (whose decision shall be final and binding upon the Purchaser) shall, on demand, be paid by the Purchaser to the Government.
- (q) For the purpose of calculating the total gross floor area stipulated in Special Condition No.(7)(c) hereof, the Public Open Space shall not be taken into account.
- (r) For the purpose of this Special Condition, the expression “Purchaser” shall exclude his assigns.”

(2) Relevant provisions of the Deed of Mutual Covenant that concern the above facilities:

N/A

2. Promenade Area as referred to in Special Condition No.(10) of the Land Grant

(1) Relevant provisions of the Land Grant that concern the above facilities:

Special Condition No.(10) of the Land Grant stipulates that: -

- “(a) The Purchaser shall at his own expense and in all respects to the satisfaction of the Director lay, form, erect, construct, provide and landscape in a good workmanlike manner, with such materials and to such standards, levels, alignment and design as the Director shall approve and in accordance with the plans approved under sub-clause (b)(i) of this Special Condition a waterfront promenade within the areas shown coloured yellow and yellow hatched brown on the plan annexed hereto (hereinafter respectively referred to as “**the Yellow Area**”

and “**the Yellow Hatched Brown Area**” and hereinafter collectively referred to as “**the Promenade Area**”), to be completed and made fit for occupation and operation not later than the 31st day of March 2025 or such other extended date as may be approved by the Director. The Purchaser shall, until the Promenade Area shall have been re-delivered to the Government in accordance with sub-clause (f)(ii) of this Special Condition, at his own expense uphold, maintain, repair and manage the Promenade Area together with everything thereon in all respects to the satisfaction of the Director.

- (b)(i) The Purchaser shall at his own expense submit or cause to be submitted to the Director for his written approval plans of the Promenade Area, which shall include details and information as to the level, position, alignment and design of the Promenade Area and such other details and information as the Director may require.
- (b)(ii) No amendment, variation, alteration, modification or substitution to the plans of the Promenade Area approved under sub-clause (b)(i) of this Special Condition shall be made by the Purchaser except with the prior written approval of the Director or except as required by him.
- (b)(iii) The plans of the Promenade Area approved under sub-clause (b)(i) of this Special Condition shall be deemed to incorporate any amendment, variation, alteration, modification or substitution subsequently approved or required by the Director under sub-clause (b)(ii) of this Special Condition.
- (b)(iv) No building works (other than ground investigation) shall be commenced on or within the Promenade Area or any part thereof unless and until approval of the plans under sub-clause (b)(i) of this Special Condition shall have been obtained.
- (c)(i) The Purchaser shall not alter, demolish or damage the seawall within the Promenade Area or carry out any works which will adversely affect the seawall or any part or parts thereof and the decision of the Director as to whether any works will adversely affect the seawall shall be final and binding upon the Purchaser.
- (c)(ii) The maximum superimposed load within 10 metres from and behind the copeline of the seawall shall not exceed 10 kilonewtons per square metre.
- (c)(iii) No form of percussive piling shall be used within 15 metres from the copeline of the seawall.
- (d) In the event of the non-fulfilment of the Purchaser’s obligations under sub-clause (a) of this Special Condition by the date specified therein or such other extended date as may be approved by the Director, the Government may carry out the necessary works at the cost of the Purchaser who shall pay to the Government on demand a sum equal to the cost thereof, such sum to be determined by the Director whose determination shall be final and binding on the Purchaser.

- (e) The Government shall have no responsibility or liability in respect of any loss, damage, nuisance or disturbance whatsoever caused to or suffered by the Purchaser or any other persons whether arising out of or incidental to the fulfilment of the Purchaser's obligations under sub-clause (a) of this Special Condition or the exercise of the rights by the Government under sub-clause (d) of this Special Condition or otherwise, and no claim whatsoever shall be made against the Government by the Purchaser in respect of any such loss, damage, nuisance or disturbance.
- (f)(i) For the purpose only of carrying out the works specified in sub-clause (a) of this Special Condition, the Purchaser shall :
- (I) on the date of this Agreement be deemed to have been granted possession of the Yellow Area; and
- (II) on a date or dates to be specified in a letter or letters from the Director to the Purchaser, which date or dates in any event shall not be later than the 31st day of December 2018, be deemed to have been granted possession of the Yellow Hatched Brown Area or any part or parts thereof.
- (f)(ii) The Promenade Area shall be re-delivered to the Government by the Purchaser on demand without any payment or compensation to the Purchaser, and in any event shall be deemed to have been re-delivered to the Government by the Purchaser on the date of a letter from the Director indicating that these Conditions have been complied with to his satisfaction.
- (f)(iii) The Purchaser shall accept the Yellow Area and the Yellow Hatched Brown Area or any part or parts thereof in such state and condition and with such structures and foundations (if any) as existing on the respective dates on which possession of the Yellow Area and the Yellow Hatched Brown Area or any part or parts thereof is deemed to be given to the Purchaser, and no claim whatsoever shall be made against the Government by the Purchaser in respect thereof.
- (f)(iv) The Government shall have no responsibility or liability in respect of any damage, loss, nuisance or disturbance whatsoever caused to or suffered by the Purchaser or any person arising whether directly or indirectly out of or in connection with the provisions of sub-clause (f)(i)(II) of this Special Condition pursuant to which the giving of the possession of the Yellow Hatched Brown Area or any part or parts thereof shall be deferred, and no claim for compensation, refund of premium or otherwise whatsoever shall be made against the Government by the Purchaser in respect of any such damage, loss, nuisance or disturbance.
- (g)(i) The Purchaser shall at all times prior to the re-delivery of possession of the whole or any part or parts of the Promenade Area :
- (I) permit the Government, the Director and his officers, contractors and agents and any other persons authorized by the Director, with or without tools, equipment, plant, machinery or motor vehicles, the right of ingress, egress and regress to, from and through the lot and the Promenade Area for the purpose of inspecting, checking and supervising any works to be carried out in compliance with sub-clause (a) of this Special Condition and the carrying out, inspecting, checking and supervising of the works under sub-clause (d) of this Special Condition and any other works which the Director may consider necessary within the Promenade Area;
- (II) permit the Government and the relevant public utility companies authorized by the Government, with or without tools, equipment, plant, machinery or motor vehicles, the right of ingress, egress and regress to, from and through the lot and the Promenade Area as the Government or the relevant public utility companies may require for the purpose of any works to be carried out in, upon or under the Promenade Area or any adjoining land including but not limited to the laying and subsequent maintenance of all pipes, wire, conduits, cable-ducts and other conducting media and ancillary equipment necessary for the provision of telephone, electricity, gas (if any) and other services intended to serve the lot or any adjoining or neighbouring land or premises, and the Purchaser shall co-operate fully with the Government and also with the relevant public utility companies duly authorized by the Government on all matters relating to any of the aforesaid works to be carried out within the Promenade Area; and
- (III) permit the officers of the Water Authority and such other persons as may be authorized by them, with or without tools, equipment, plant, machinery or motor vehicles, the right of ingress, egress and regress to, from and through the lot and the Promenade Area as the officers of the Water Authority or such authorized persons may require for the purpose of carrying out any works in relation to the operation, maintenance, repairing, replacement and alteration of any waterworks installations within the Promenade Area;
- (g)(ii) The Government, the Director and his officers, contractors, agents and any other persons or public utility companies duly authorized under sub-clause (g)(i) of this Special Condition shall have no responsibility or liability in respect of any loss, damage, nuisance or disturbance whatsoever caused to or suffered by the Purchaser or any other person arising out of or incidental to the exercise of the rights by the Government, the Director and his officers, contractors, agents and any other persons or public utility companies duly authorized under sub-clause (g)(i) of this Special Condition, and no claim whatsoever shall be made by the Purchaser against the Government, the Director and his officers, contractors, agents and any other persons authorized by the Director in respect of any such loss, damage, nuisance or disturbance.
- (h) The Purchaser shall indemnify and keep indemnified the Government and the Director from and against all liabilities, losses, damages, expenses, claims, costs, demands, charges, actions and proceedings of whatsoever nature arising out of or as a consequence of the carrying out, performance or fulfilment of his obligations under this Special Condition.

- (i) The Director shall have the right at his absolute discretion to nominate representatives (hereinafter referred to as “**the Nominated Representatives**”) who shall on his behalf monitor and generally oversee the design, erection, construction, provision and completion of the Promenade Area.
- (j) The Purchaser, his servants, agents, contractors and workmen shall make available all drawings and site records and shall render all necessary assistance and cooperation to the Nominated Representatives when required by the Nominated Representatives in relation to their duties under this Special Condition.
- (k) The Government and the Director shall accept no responsibility or liability for any liabilities, losses, costs, expenses, claims, demands, charges, damages, actions and proceedings of whatsoever nature arising out of or in connection with the exercise by the Nominated Representatives of their duties under this Special Condition.
- (l) The Purchaser shall as soon as practicable but not later than three calendar months from the date of re-delivery of the Promenade Area in accordance with sub-clause (f) (ii) of this Special Condition, at his own expense and in all respects to the satisfaction of the Director, provide to the Director free of all costs and charges all documents with detailed specifications, working drawings, catalogues, part lists for all fittings, fixtures and installations and the as-built drawings for the Promenade Area.
- (m) The Purchaser shall indemnify and keep indemnified the Government against all liabilities, losses, claims, costs, expenses, demands, charges, damages, actions and proceedings of whatsoever nature arising out of or in connection with any defects, wants of repair, settlements, imperfections, breakdown, faults or any other outstanding works (whether in respect of workmanship, materials, design or otherwise) in the Promenade Area or any part thereof.
- (i) which may exist at the date of re-delivery by the Purchaser to the Government of the Promenade Area in accordance with sub-clause (f)(ii) of this Special Condition; and
- (ii) which shall occur or become apparent within a period of 365 days from the date of re-delivery by the Purchaser to the Government of the Promenade Area in accordance with sub-clause (f)(ii) of this Special Condition (which period is hereinafter referred to as “**the Defects Liability Period of the Promenade Area**”).
- (n) Whenever required by the Director or the Nominated Representatives, the Purchaser shall at his own expense and within such time and to such standard and in such manner as may be specified by the Director or the Nominated Representatives carry out all works of maintenance, repair, amendment, reconstruction and rectification and any other works as may be necessary to remedy and rectify any defects, wants of repair, settlements, imperfections, breakdown, faults or any other outstanding works in the Promenade Area or any part thereof which shall occur or become apparent within the Defects Liability Period of the Promenade Area. In addition to the foregoing, the Purchaser shall at his own expense and within such time and to such standard and in such manner as may be specified by the Director or the Nominated Representatives make good and rectify any defects, wants of repair, settlements, imperfections, breakdown, faults or any other outstanding works in the Promenade Area or any part thereof which may exist upon re-delivery thereof to the Government by the Purchaser.
- (o) The Director or the Nominated Representatives will, shortly before the expiry of the Defects Liability Period of the Promenade Area, cause an inspection to be carried out in respect of the Promenade Area or any part thereof for the purpose of identifying any defects, wants of repair, settlements, imperfections, breakdown, faults or any other outstanding works which may be evident. The Director and the Nominated Representatives reserve the right to each of them to serve upon the Purchaser within fourteen days after the expiry of the Defects Liability Period of the Promenade Area a schedule or schedules of defects specifying any defects, wants of repair, settlements, imperfections, breakdown, faults or any other outstanding works which may be evident in the Promenade Area or any part thereof and the Purchaser shall at his own expense cause all necessary works to be carried out so as to remedy and rectify the same within such time limit and to such standard and in such manner as may be specified by the Director or the Nominated Representatives.
- (p) If the Purchaser shall fail to carry out any of the works referred to in sub-clauses (n) and (o) of this Special Condition, then any such works may be carried out by the Government and all costs and charges incurred in connection therewith by the Government as certified by the Director (whose decision shall be final and binding upon the Purchaser) shall, on demand, be paid by the Purchaser to the Government.
- (q) For the purpose of this Special Condition, the expression “Purchaser” shall exclude his assigns.
- (2) Relevant provisions of the Deed of Mutual Covenant that concern the above facilities:
- N/A
- B. Facilities that are required under the Land Grant to be managed, operated or maintained for public use at the expense of the owners of the residential properties in the Phase**
- Not Applicable.

C. Size of any open space that is required under the Land Grant to be managed, operated or maintained for public use at the expense of the owners of the residential properties in the Phase

Not Applicable.

D. Any part of the land (on which the Phase is situated) that is dedicated to the public for the purposes of regulation 22(1) of the Building (Planning) Regulations (Cap.123 Sub. Leg. F)

Not Applicable.

Notes:

1. The expression as mentioned in this section “Director” means “the Director of Lands”, unless otherwise specified.
2. The expression “Purchaser” as mentioned in this section means the “Purchaser” under the Land Grant and under Summary of Land Grant, and where the context so admits or requires includes his executors, administrators and assigns and in case of a corporation its successors and assigns.

A. 根據批地文件規定須興建並提供予政府或供公眾使用的設施

1. 批地文件特別條件第(9)條所指之公眾休憩用地

(1) 關於上述設施的批地文件相關條款：

批地文件 (經日期為2020年8月26日的延期信函修訂) 特別條件第(9)條訂明：

- (a) 買方應自費以署長全面滿意的方式，以良好工藝採用署長批准的物料、標準、水平、定線和設計，以及依照已遵從本特別條件(c)(i)分條規定審批的圖則，於該地段地面層鋪設、拓建、興建、建造、提供和進行園景美化一個面積不少於3,600平方米的公眾休憩用地(以下簡稱「**公眾休憩用地**」)，並於2025年3月31日或之前或署長批准的其他延長限期建成並適宜佔用和運作。公眾休憩用地應由買方自費採用署長指定的方式、物料、設備及設施、選址、拓建、保養、園景美化、種植花木、處理和提供，以全面令署長滿意。署長就何謂本(a)分條所指地面層所作的決定將作終論，並對買方有約束力。直至公眾休憩用地遵照本特別條件(e)(ii)分條規定交還政府為止，買方須自費保養、維修、修理和管理公眾休憩用地連同該處的所有物件，以全面令署長滿意。
- (b) 不得在公眾休憩用地之上、跨越其上或其下或在其範圍內搭建、建造或放置任何建築物、構築物或其支撐物，惟署長根據本特別條件(c)(i)分條指定或批准的構築物除外。
- (c)(i) 買方應自費向署長提交或達致向署長提交公眾休憩用地的圖則，以便署長書面審批。圖則應涵蓋公眾休憩用地的水平、位置、定線及設計的詳情和資料，以及署長要求的其他詳情和資料。
- (c)(ii) 公眾休憩用地圖則根據本特別條件(c)(i)分條批核後，買方如事前未獲署長書面批准又或經署長指定，概不得作出修改、更改、修訂、改動或取代。
- (c)(iii) 根據本特別條件(c)(i)分條批核的公眾休憩用地圖則將視作已納入署長其後根據本特別條件(c)(ii)分條批准或指定的任何修改、更改、修訂、改動或取代內容。
- (d) 倘買方不在本特別條件(a)分條訂明的日期或署長批准的其他延長期限內履行該條訂明的責任，政府可執行必要的工程，費用由買方支付。買方須在政府通知時支付有關的費用，付款金額由署長釐定，其決定將作終論，並對買方有約束力。
- (e) 儘管有本文特別條件第(16)及(19)條之規定：
- (i) 公眾休憩用地按照本特別條件(e)(ii)分條交還政府之前，買方應自費簽訂署長指定或批准格式和條文的分割契約，以從該地段分割公眾休憩用地。買方應自費於土地註冊處註冊分割契約，以全面令署長滿意。如上辦妥註冊之前，

不可進行任何涉及該地段或其任何部分或該處已建或擬建建築物或建築物任何部分的交易(本特別條件第(16)(d)條訂明的建築按揭或署長批准的其他交易除外)。於分割公眾休憩用地之前，買方應自費向署長提交將公眾休憩用地從該地段分割的分割契約，以供署長書面批核；

- (ii) 買方以署長全面滿意的方式履行此等批地條件之前，又或在署長通知時(二者取其較早時間)，買方應自費以交吉形式向政府交還和騰空交回公眾休憩用地，連同署長根據本特別條件(c)(i)分條審批的圖則註明之物料、設備、設施及構築物，不得有任何留置權，而政府亦毋須向買方支付任何代價、款項或彌償。然而，政府概無責任必須按照買方要求收回公眾休憩用地，政府可按其視為恰當收回有關的土地。買方須就此遵照署長規定的條款與條件，自費訂立一份或多份土地交還契約和署長批准或指定格式和條文的任何其他必要文件。買方概無權基於交還公眾休憩用地而直接或間接引起或導致之任何損失、損害或補償向政府索償；
- (iii) 買方不可轉讓、按揭、押記、讓予、分租、出讓或以其他方式處置或抵押公眾休憩用地或其任何一個或多個部分或當中任何權益，或就此訂立任何協議。惟本(e)(iii)分條並不適用於按照本特別條件(e)(i)分條分割公眾休憩用地、依照本特別條件(e)(ii)分條規定向政府交還公眾休憩用地或本文特別條件第(16)(d)條訂明的建築按揭；及
- (iv) 買方同意及接納，公眾休憩用地根據本特別條件(e)(ii)分條交回政府後，買方發展或重建該地段或其任何部分時可能因為該地段面積縮減等理由而無法取得本文特別條件第(7)(c)條訂明的最大樓面總面積。倘無法取得本文特別條件第(7)(c)條訂明的最大樓面總面積，政府概無任何義務或責任，而買方不可向政府申索賠償或退還地價等。
- (f) 倘因買方進行、執行或履行本特別條件訂明的責任導致或引起任何性質的責任、損失、損害、開支、索償、費用、訴求、收費、訴訟及法律程序，買方須向政府及署長作出賠償並確保彼等免責。
- (g) 署長可全權酌情指定代表(以下簡稱「**政府代表**」)，以代表署長監察及一般地統籌設計、興建、建造、提供和建成公眾休憩用地。
- (h) 買方、其傭工、代理、承辦商和工人均須在政府代表通知時提供所有與本特別條件訂明其應履行職責相關的圖則及工地記錄，並要提供所有必要協助和合作。
- (i) 倘因政府代表行使本特別條件訂明的職責招致或引起任何性質的費用、責任、損失、開支、索償、訴求、收費、損害、訴訟及法律程序，政府及署長概不承擔任何義務或責任。
- (j) 於公眾休憩用地根據本特別條件(e)(ii)分條交還政府之前，買方必須允許署長、其人員、承辦商、代理、工人及署長授權的任何其他人等(包括但不限於政府代表)行使權利，不論攜帶工具、設備、機器、機械或駕車與否，自由及不受限制地通

- 行、進出、往返及行經該地段或其任何部分和該處任何已建或擬建的一座或多座建築物，以便檢查、檢驗及監督任何遵照本特別條件(a)分條執行的工程，以及按照本特別條件(d)及(p)分條規定執行任何工程或署長認為有必要實施的任何其他工程。
- (k) 倘因為或鑒於買方履行本特別條件訂明的責任，或因署長行使本特別條件(j)分條訂明的進入權，又或執行本特別條件(d)及(p)分條所載的任何工程，導致或連帶引致買方或任何其他人士招致或蒙受任何損失、損害、滋擾或騷擾，政府或署長概毋須承擔任何義務或責任。買方無權對政府、署長或其授權人員(包括但不限於政府代表)提出任何索償，亦不會就此等損失、損害、滋擾或騷擾獲得任何彌償。
- (l) 買方應盡早而最遲於公眾休憩用地依照本特別條件(e)(ii)分條交還後三個曆月內，自費以署長全面滿意的方式，完全免費地向署長提供公眾休憩用地的所有文件連同詳細規格、工作圖則、目錄、所有配件、固定裝置及裝設的零件清單和竣工記錄圖。
- (m) 倘公眾休憩用地或其任何部分有任何不良缺點、失修、沉降、不善、失靈、故障或任何其他未完成工程(不論關乎工藝、質料或設計等)，而於：
- (i) 買方遵照本特別條件(e)(ii)分條規定將公眾休憩用地交還政府當日現存；及
- (ii) 買方遵照本特別條件(e)(ii)分條規定將公眾休憩用地交還政府當日後365日內的期間(以下簡稱「**公眾休憩用地保修期**」)出現或可見，
- 買方將就由此引致或招致的任何性質之責任、損失、開支、索償、費用、訴求、收費、損害、訴訟及法律程序向政府作出賠償並確保其免責。
- (n) 只要署長或政府代表要求，買方須自費按照署長或政府代表指定的期限、標準和方式執行所有必要的維修、修理、更改、重建、補救及任何其他工程，以補救及糾正公眾休憩用地或其任何部分於公眾休憩用地保修期內出現或可見的不良缺點、失修、沉降、不善、失靈、故障或任何其他未完成工程。買方除要遵從前文的規定外，並須自費按照署長或政府代表指定的期限、標準及方式修復和糾正在買方向政府交還公眾休憩用地或其任何部分當日已存在的任何不良缺點、失修、沉降、不善、失靈、故障或任何其他未完成工程。
- (o) 署長或政府代表將於公眾休憩用地保修期即將屆滿時達致派員檢驗公眾休憩用地或其任何部分，以查看是否發現任何不良缺點、失修、沉降、不善、失靈、故障或任何其他未完成工程。署長及政府代表保留權利於公眾休憩用地保修期結束後十四天內向買方發出保修列表，列明公眾休憩用地或其任何部分的任何不良缺點、失修、沉降、不善、失靈、故障或任何其他未完成工程，買方應自費依照署長或政府代表指定的期限、標準和方式達致執行所有必要工程，以作修葺和糾正。
- (p) 如買方不執行本特別條件(n)及(o)分條列明的任何工程，政府可自行執行此等工程，買方須在接獲通知時向政府支付政府由此招致而經署長核實(其決定將作終論並對買方有約束力)的所有費用及收費。
- (q) 遵照本文特別條件第(7)(c)條計算所有樓面總面積時，公眾休憩用地不會連計在內。
- (r) 就本特別條件而言，「買方」一詞的釋義並不包括其受讓人。
- (2) 關於上述設施的公契相關條款：
- 不適用。
- ## 2. 批地文件特別條件第(10)條所載的海濱廣場範圍
- (1) 關於上述設施的批地文件相關條款：
- 批地文件特別條件第(10)條訂明：
- 「(a) 買方應自費以署長全面滿意的方式，以良好工藝採用署長批准的物料、標準、水平、定線和設計，以及依照已遵從本特別條件(b)(i)分條規定審批的圖則，在本文所夾附圖則以黃色、黃色間棕色斜線顯示的範圍(以下分別簡稱「**黃色範圍**」、「**黃色間棕色斜線範圍**」並統稱「**海濱廣場範圍**」)鋪設、拓建、興建、建造、提供和園景美化一個海旁海濱廣場，並於2025年3月31日或之前或於署長批准的延長期限內建成並適宜佔用和運作。直至海濱廣場範圍按照本特別條件(f)(ii)分條交還政府為止，買方須自費以署長全面滿意的方式保養、維修、修理和管理海濱廣場範圍連同該處的所有物件。
- (b)(i) 買方應自費向署長提交或達致向署長提交海濱廣場範圍的圖則，以便署長書面審批。圖則應涵蓋海濱廣場範圍的水平、位置、定線及設計的詳情和資料，以及署長要求的其他詳情和資料。
- (b)(ii) 海濱廣場範圍圖則根據本特別條件(b)(i)分條批核後，買方如事前未獲署長書面批准又或經署長指定，概不得作出修改、更改、修訂、改動或取代。
- (b)(iii) 根據本特別條件(b)(i)分條批核的海濱廣場範圍圖則將視作已納入署長其後根據本特別條件(b)(ii)分條批准或指定的任何修改、更改、修訂、改動或取代內容。
- (b)(iv) 除非及直至圖則已遵照本特別條件(b)(i)分條獲得批核，否則不得在海濱廣場範圍或其任何部分之上或之內展開任何建築工程(土地勘測工程除外)。

- (c)(i) 買方不可更改、拆卸或損壞海濱廣場範圍內的海堤，或進行任何會對海堤或其任何一個或多個部分構成不良影響的工程。署長就何等工程會對海堤構成不良影響所作的決定將作終論，並對買方有約束力。
- (c)(ii) 海堤蓋頂線對開及後方10米範圍內的最大附加承重負荷不可超過每平方米10千牛頓。
- (c)(iii) 海堤蓋頂線15米範圍內不得進行任何形式的撞擊式打樁工程。
- (d) 倘買方不在本特別條件(a)分條指定的日期前或署長批准的其他延長期限內履行該條訂明的責任，政府可執行必要的工程，費用由買方支付。買方須在政府通知時支付有關的費用，付款金額由署長釐定，其決定將作終論，並對買方有約束力。
- (e) 如因買方履行本特別條件(a)分條所訂責任，或因政府行使本特別條件(d)分條訂明的權利等，導致及連帶引致買方或任何其他人士招致或蒙受任何損失、損害、滋擾或騷擾，政府概不承擔任何義務或責任，買方不可就任何此等損失、損害、滋擾或騷擾向政府提出索償。
- (f)(i) 茲為執行本特別條件(a)分條所訂的工程，買方將：
- (I) 於本協議訂立日獲授予黃色範圍的佔管權；及
- (II) 被視作已於署長發函指定的一個或多個日期獲授予黃色間棕色斜線範圍或其任何一個或多個部分的佔管權。惟上述日期不可遲逾2018年12月31日。
- (f)(ii) 買方應在接獲通知時將海濱廣場範圍交還政府，政府不會向買方支付任何款項或彌償，而於任何情況下海濱廣場範圍亦會被視為於署長發函說明買方已以其滿意的方式全面履行此等批地條件當日交還政府。
- (f)(iii) 買方將全面接納黃色範圍及黃色間棕色斜線範圍或其任何一個或多個部分的狀態和情況，以及在買方已分別被視作取得黃色範圍及黃色間棕色斜線範圍或其任何一個或多個部分佔管權當日現存的構築物和地基(如有)。買方不得就此向政府提出任何索償。
- (f)(iv) 倘因有本特別條件(f)(i)(II)分條之規定而導致延遲移交黃色間棕色斜線範圍或其任何一個或多個部分的佔管權，從而直接或間接造成或致使買方或任何人士招致或蒙受任何損害、損失、滋擾或騷擾，政府概不承擔任何義務或責任，買方不可就任何此等損害、損失、滋擾或騷擾向政府索取賠償或要求退回地價等。
- (g)(i) 買方交還海濱廣場範圍整體或其任何一個或多個部分佔管權之前，時刻均須：
- (I) 允許政府、署長、其人員、承辦商、代理及署長授權的任何其他人等，不論攜帶工具、設備、機器、機械或駕車與否，行使權利通行、進出、往返和行經該地段及海濱廣場範圍，以便檢查、檢驗及監督任何遵照本特別條件(a)分條執行的工程，以及執行、檢查、檢驗和監督任何遵照本特別條件(d)分條規定的工程及署長認為有必要在海濱廣場範圍實施的任何其他工程。
- (II) 允許政府及政府授權的相關公用事業公司行使權利，不論攜帶工具、設備、機器、機械或駕車與否，按彼等需要通行、進出、往返和行經該地段及海濱廣場範圍，以便於海濱廣場範圍或任何毗連土地之內、其上或其下執行工程，包括但不限於鋪設及其後維修所有水管、電線、管線、電纜管道和其他導體及附屬設備，以便提供擬供該地段或任何毗連或毗鄰土地或處所使用的電話、電力、燃氣(如有)及其他服務。買方應與政府和政府授權的相關公用事業公司充分合作，以處理所有關乎在海濱廣場範圍內執行任何上述工程的事項；及
- (III) 允許水務監督人員及彼等授權的其他人等行使權利，不論攜帶工具、設備、機器、機械或駕車與否，按水務監督人員及彼等授權人士需要通行、進出、往返和行經該地段及海濱廣場範圍，以執行任何關於運作、維修、修理、更換及更改海濱廣場範圍內任何其他水務裝置的工程；
- (g)(ii) 倘因政府、署長及其人員、承辦商及代理和任何其他人士或根據本特別條件(g)(i)分條正式獲授權的公用事業公司行使權利，導致或連帶引致買方或任何其他人士招致或蒙受任何損失、損害、滋擾或騷擾，政府、署長及其人員、承辦商及代理和任何其他人士等或根據本特別條件(g)(i)分條正式獲授權的公用事業公司概毋須就此承擔任何義務或責任，買方不得就任何此等損失、損害、滋擾或騷擾向政府、署長及其人員、承辦商、代理和任何其他獲署長授權人等索償。
- (h) 倘因買方進行、執行或履行本特別條件所訂的責任而導致或引起任何性質的責任、損失、損害、開支、索償、費用、訴求、收費、訴訟及法律程序，買方須向政府及署長作出賠償並確保彼等免責。
- (i) 署長可全權酌情指定代表(以下簡稱「指定代表」)，代表署長監察及一般地統籌設計、興建、建造、提供和建成海濱廣場範圍。
- (j) 買方、其傭工、代理、承辦商和工人均須在指定代表通知時提供所有與本特別條件訂明其應履行職責相關的圖則及工地記錄，並要提供所有必要協助和合作。
- (k) 倘因指定代表行使本特別條件訂明的職責招致或引起任何性質的責任、損失、費用、開支、索償、訴求、收費、損害、訴訟及法律程序，政府及署長概不承擔任何義務或責任。
- (l) 買方應盡早而最遲於海濱廣場範圍依照本特別條件(f)(ii)分條交還後三個曆月內，自費以署長全面滿意的方式，完全免費地向署長提供海濱廣場範圍的所有文件連同

詳細規格、工作圖則、目錄、所有配件、固定裝置及裝設的零件清單和竣工記錄圖。

- (m) 倘海濱廣場範圍或其任何部分有任何不良缺點、失修、沉降、不善、失靈、故障或任何其他未完成工程(不論關乎工藝、質料、設計等)，而於：

- (i) 買方遵照本特別條件(f)(ii)分條規定將海濱廣場範圍交還政府當日現存；及
- (ii) 買方遵照本特別條件(f)(ii)分條規定將海濱廣場範圍交還政府當日後365日內的期間(以下簡稱「海濱廣場範圍保修期」)出現或可見，

買方將就由此引致起或招致的任何性質之責任、損失、索償、費用、開支、訴求、收費、損害、訴訟及法律程序向政府作出賠償並確保其免責。

- (n) 只要署長或指定代表要求，買方須自費按照署長或指定代表指定的期限、標準和方式執行所有必要的維修、修理、更改、重建、補救及任何其他工程，以補救及糾正海濱廣場範圍或其任何部分於海濱廣場範圍保修期內出現或可見的不良缺點、失修、沉降、不善、失靈、故障或任何其他未完成工程。買方除要遵從前文的規定外，並須自費按照署長或指定代表指定的期限、標準及方式修復和糾正在買方向政府交還海濱廣場範圍或其任何部分當日已存在的任何不良缺點、失修、沉降、不善、失靈、故障或任何其他未完成工程。
- (o) 署長或指定代表將於海濱廣場範圍保修期即將屆滿時達致派員檢驗海濱廣場範圍或其任何部分，以查看是否發現任何不良缺點、失修、沉降、不善、失靈、故障或任何其他未完成工程。署長及指定代表保留權利於海濱廣場範圍保修期完結後十四天內向買方發出保修列表，列明海濱廣場範圍或其任何部分的任何不良缺點、失修、沉降、不善、失靈、故障或任何其他未完成工程，買方應自費依照署長或指定代表指定的期限、標準和方式達致執行所有必要工程，以作修葺和糾正。
- (p) 如買方不執行本特別條件(n)及(o)分條列明的任何工程，政府可自行執行此等工程，買方須在接獲通知時向政府支付政府由此招致而經署長核實(其決定將作終論並對買方有約束力)的所有費用及收費。
- (q) 就本特別條件而言，「買方」一詞的釋義並不包括其受讓人。

(2) 關於上述設施的公契相關條款：

不適用。

- B. 根據批地文件規定須由期數中的住宅物業的擁有人出資管理、營運或維持以供公眾使用的設施**

不適用。

- C. 根據批地文件規定須由期數中的住宅物業的擁有人出資管理、營運或維持以供公眾使用的任何休憩用地的大小**

不適用。

- D. 期數所位於的土地中為施行《建築物(規劃)規例》(第123章，附屬法例F)第22(1)條而撥供公眾用途的任何部份**

不適用。

附註：



- 除另行說明外，本節中「署長」一詞指「地政總署署長」。
- 本節中「買方」一詞指批地文件及批地文件的摘要的「買方」，如上下文意允許或規定，則包括其遺產執行人、遺產管理人及受讓人，如屬公司則包括其繼承人及受讓人。

"Plan Showing the Location of the Promenade Area and Drainage Reserve Areas"
 「海濱廣場範圍及渠務專用範圍位置圖」



LEGEND

圖例

-  Promenade Area
海濱廣場範圍
-  Promenade Area
海濱廣場範圍
- DR Drainage Reserve
渠務專用
-  Drainage Reserve Areas
渠務專用範圍

Scale:  100M (米)
 比例: 0M/米



Note:



This plan is extracted from the plan annexed to the Land Grant. This plan is for showing the location of the "Promenade Area" and "Drainage Reserve Areas" only. Other matters shown in the plan may not reflect their latest conditions.

備註:

本圖摘錄自批地文件的附錄圖則。本圖僅顯示「海濱廣場範圍」及「渠務專用範圍」的位置，圖中所示的其他事項未必能反映其最新狀況。

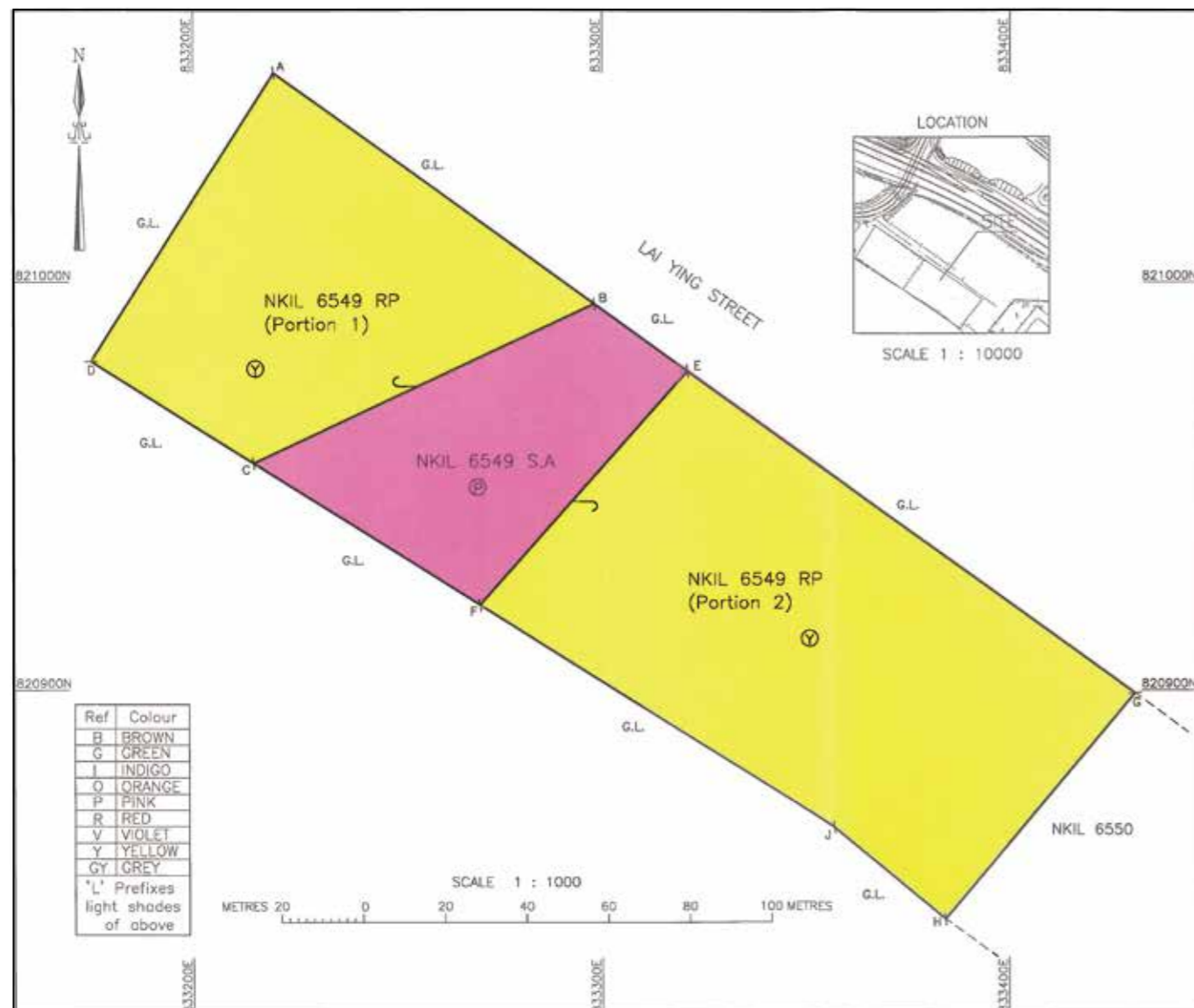
"Plan Showing the Location of the Public Open Space" 「公眾休憩用地位置圖」



Scale:  100M (米) 

比例：0M/米

LEGEND

圖例

-  Public Open Space
- 公眾休憩用地

Note:

This plan is extracted from the plan annexed to the Deed Poll dated 5th June 2020 and registered in the Land Registry by Memorial No.20060900670017. This plan is for showing the location of the "Public Open Space" only. Other matters shown in the plan may not reflect their latest conditions.

備註：

本圖摘錄自日期為2020年6月5日並在土地註冊處註冊摘要編號為20060900670017的分割契據的附錄圖則。
本圖僅顯示「公眾休憩用地」的位置。圖中所示的其他事項未必能反映其最新狀況。

1. The purchaser is hereby recommended to instruct a separate firm of solicitors (other than that acting for the owner) to act for the purchaser in relation to the transaction.
 2. If the purchaser instructs such separate firm of solicitors to act for the purchaser in relation to the transaction, that firm will be able to give independent advice to the purchaser.
 3. If the purchaser instructs the firm of solicitors acting for the owner to act for the purchaser as well, and a conflict of interest arises between the owner and the purchaser:
 - (a) That firm may not be able to protect the purchaser's interests; and
 - (b) The purchaser may have to instruct a separate firm of solicitors.
 4. In case of paragraph 3(b), the total solicitors' fees payable by the purchaser may be higher than the fees that would have been payable if the purchaser had instructed a separate firm of solicitors in the first place.
1. 謹此建議買方聘用一間獨立的律師事務所（代表擁有人行事者除外），以在此交易中代表買方行事。
 2. 如買方聘用上述的獨立的律師事務所，以在交易中代表買方行事，該律師事務所將會能夠向買方提供獨立意見。
 3. 如買方聘用代表擁有人行事的律師事務所同時代表買方行事，而擁有人與買方之間出現利益衝突：
 - (a) 該律師事務所可能不能夠保障買方的利益；及
 - (b) 買方可能要聘用一間獨立的律師事務所。
 4. 如屬上述3(b)的情況，買方須支付的律師費用總數，可能高於如買方自一開始即聘用一間獨立的律師事務所而須支付的費用。

Cross Section Plan A
橫截面圖 A

Phase 3 Tower 1(1A & 1B)
第3期 第1座(1A & 1B)

Key Plan
索引圖

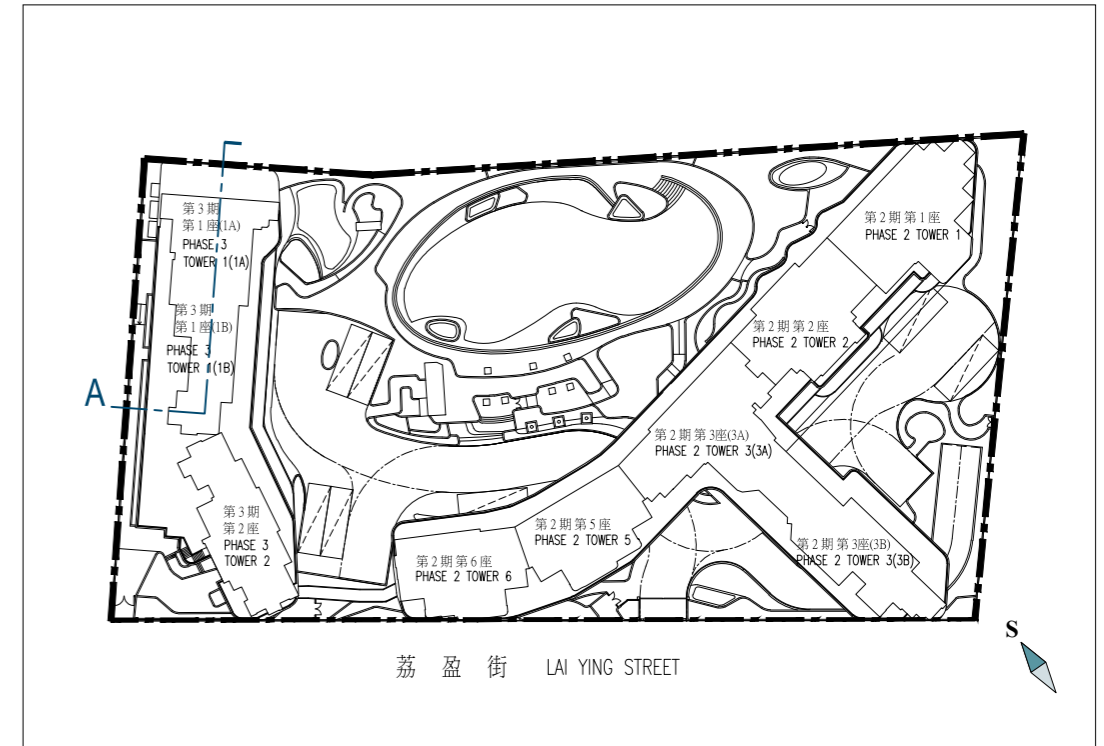
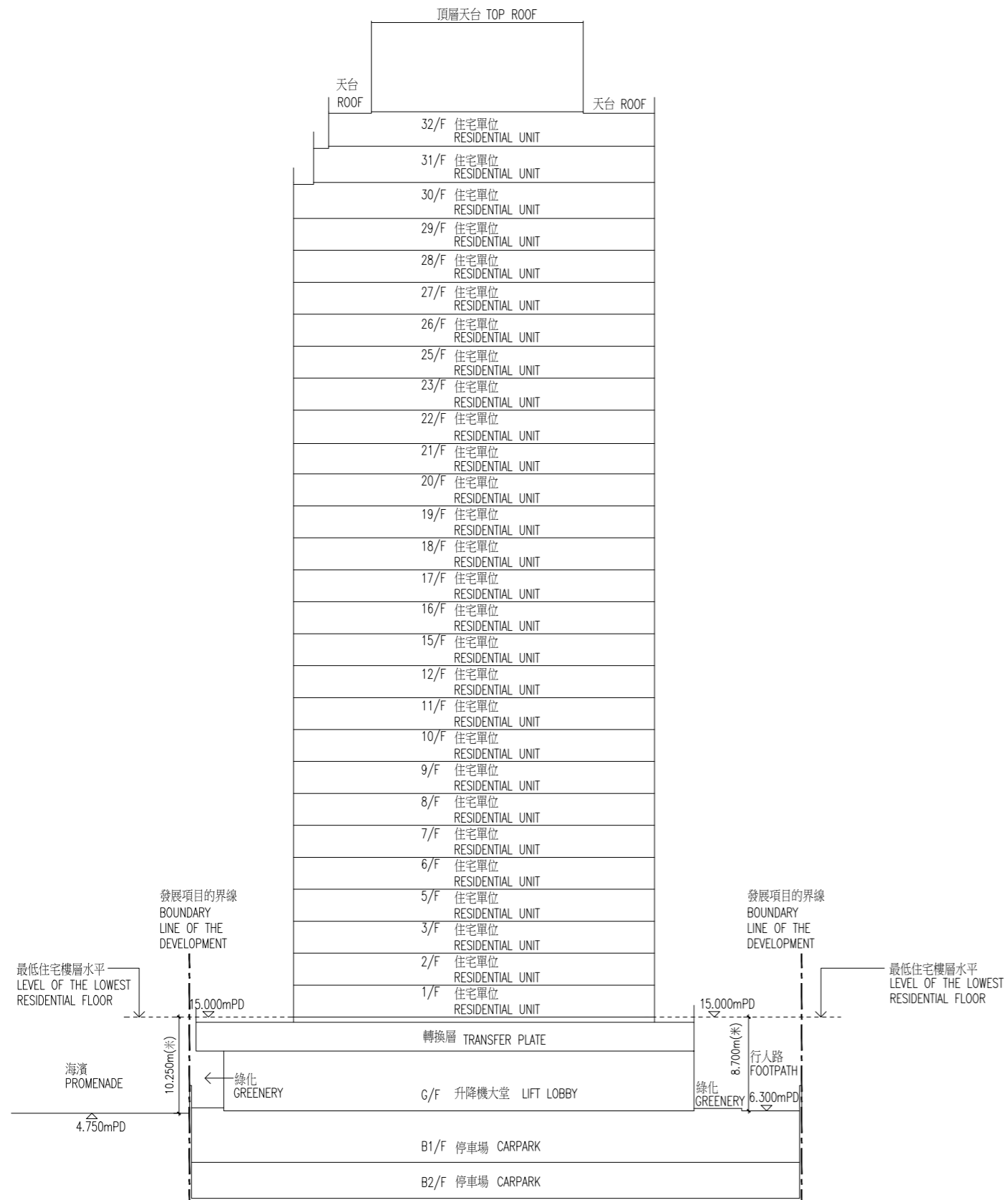

Boundary line of the Development

發展項目的界線

LEGEND 圖例

▽ Height (in metres) above Hong Kong Principal Datum (mPD).
香港主水平基準以上高度（以米計算）。

--- Dotted line denotes the level of the lowest residential floor.
虛線為最低住宅樓層水平。

The part of Footpath adjacent to the building is 6.300 metres above the Hong Kong Principal Datum.

毗鄰建築物的一段行人路為香港主水平基準以上6.300米。

The part of Promenade adjacent to the building is 4.750 metres above the Hong Kong Principal Datum.

毗鄰建築物的一段海濱為香港主水平基準以上4.750米。

Cross Section Plan B 橫截面圖 B

Phase 3 Tower 2 第3期 第2座

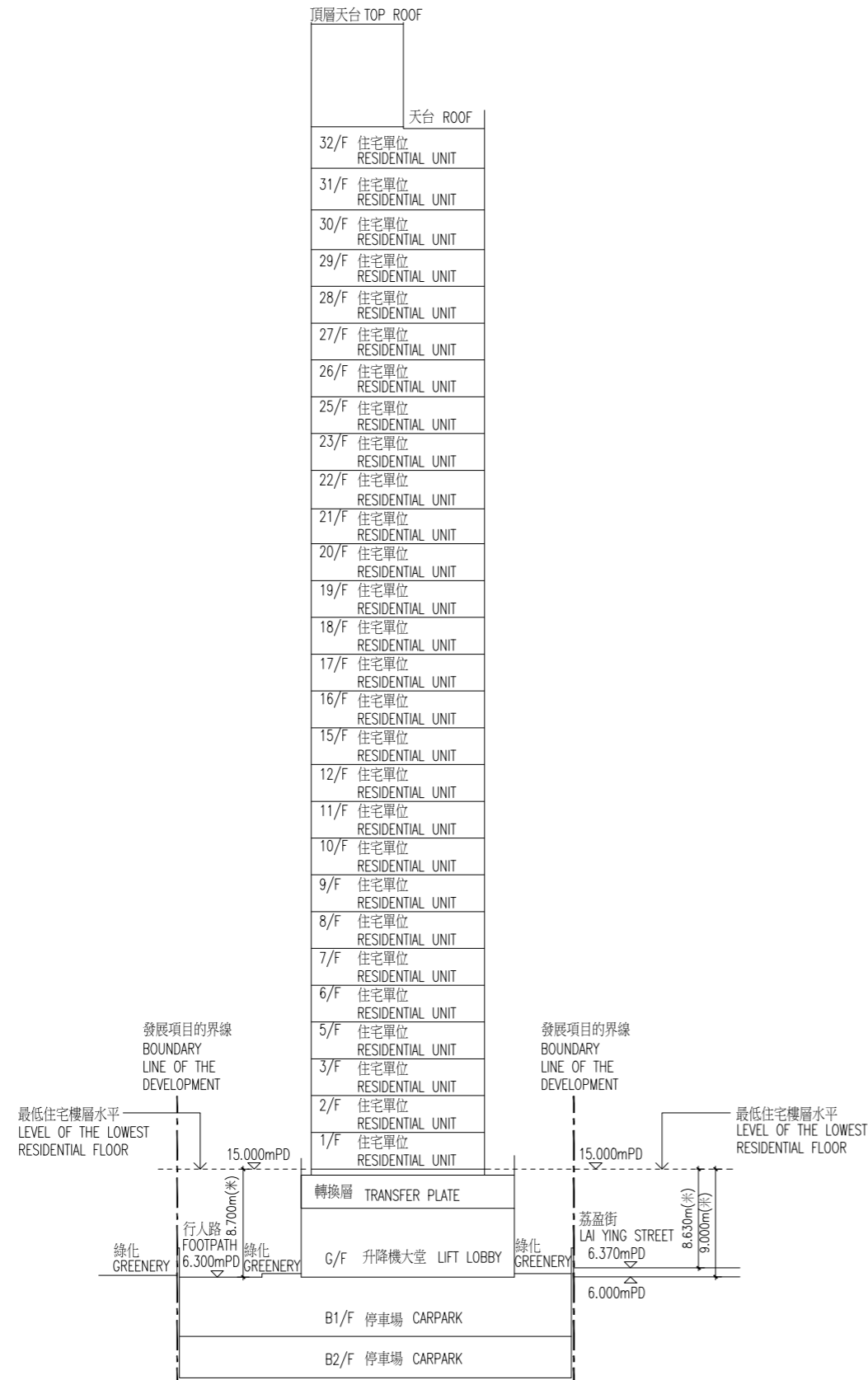

Key Plan 索引圖

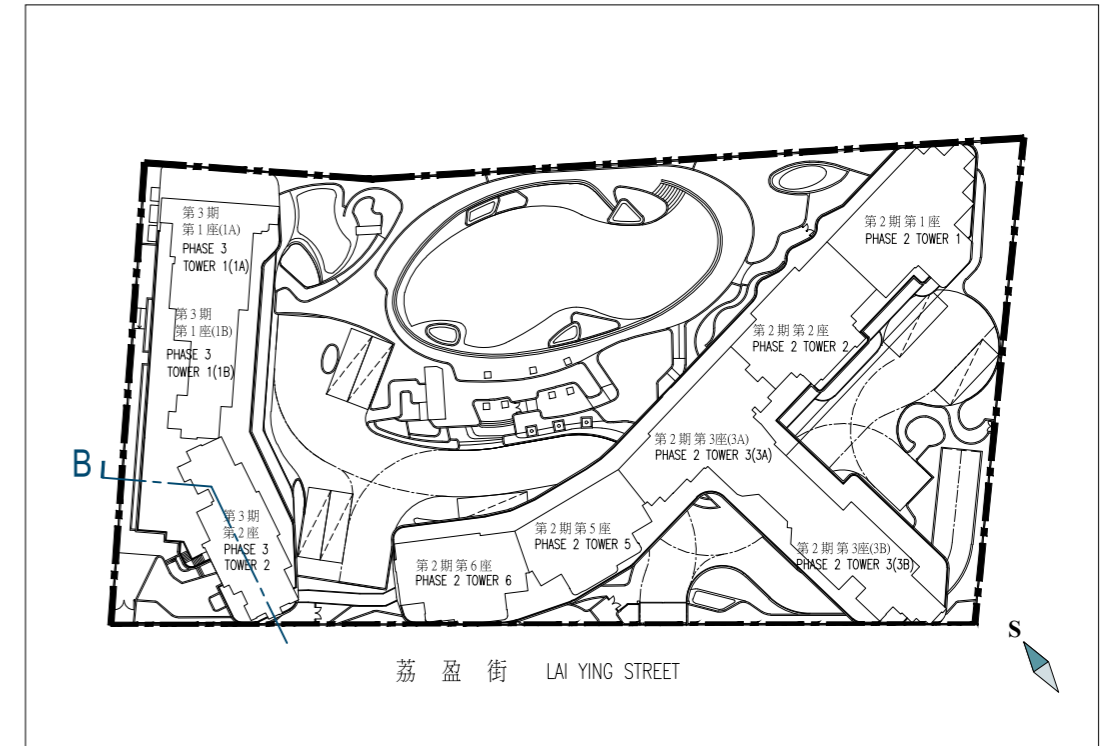

Boundary line of the Development

發展項目的界線

LEGEND 圖例

▽ Height (in metres) above Hong Kong Principal Datum (mPD).
香港主水平基準以上高度（以米計算）。

--- Dotted line denotes the level of the lowest residential floor.
虛線為最低住宅樓層水平。

The part of Footpath adjacent to the building is 6.300 metres above the Hong Kong Principal Datum.

毗鄰建築物的一段行人路為香港主水平基準以上6.300米。

The part of Lai Ying Street adjacent to the building is 6.000 metres to 6.370 metres above the Hong Kong Principal Datum.

毗鄰建築物的一段荔盈街為香港主水平基準以上6.000米至6.370米。

Elevation 1
立面圖 1

Phase 3 Tower 1(1A)
第3期 第1座(1A)

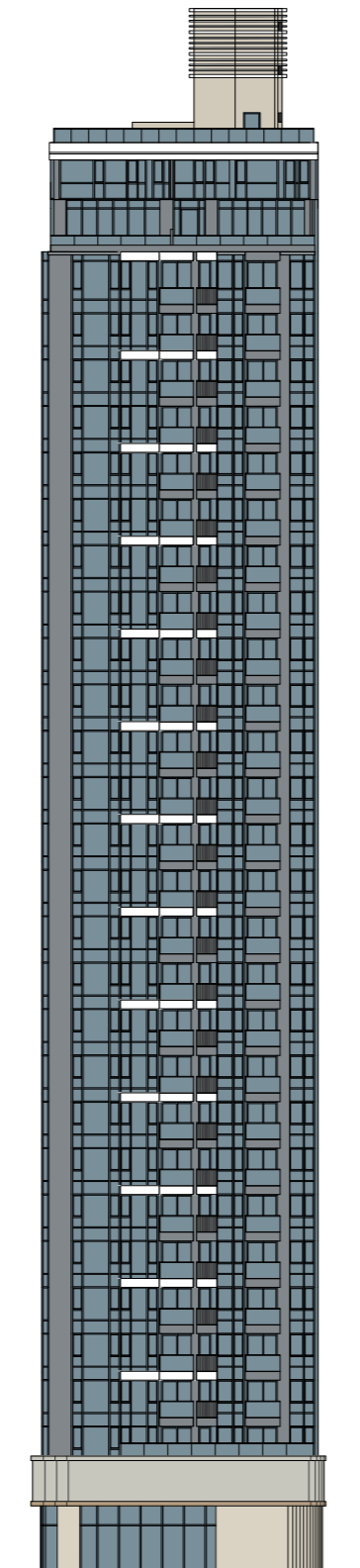

Key Plan
索引圖

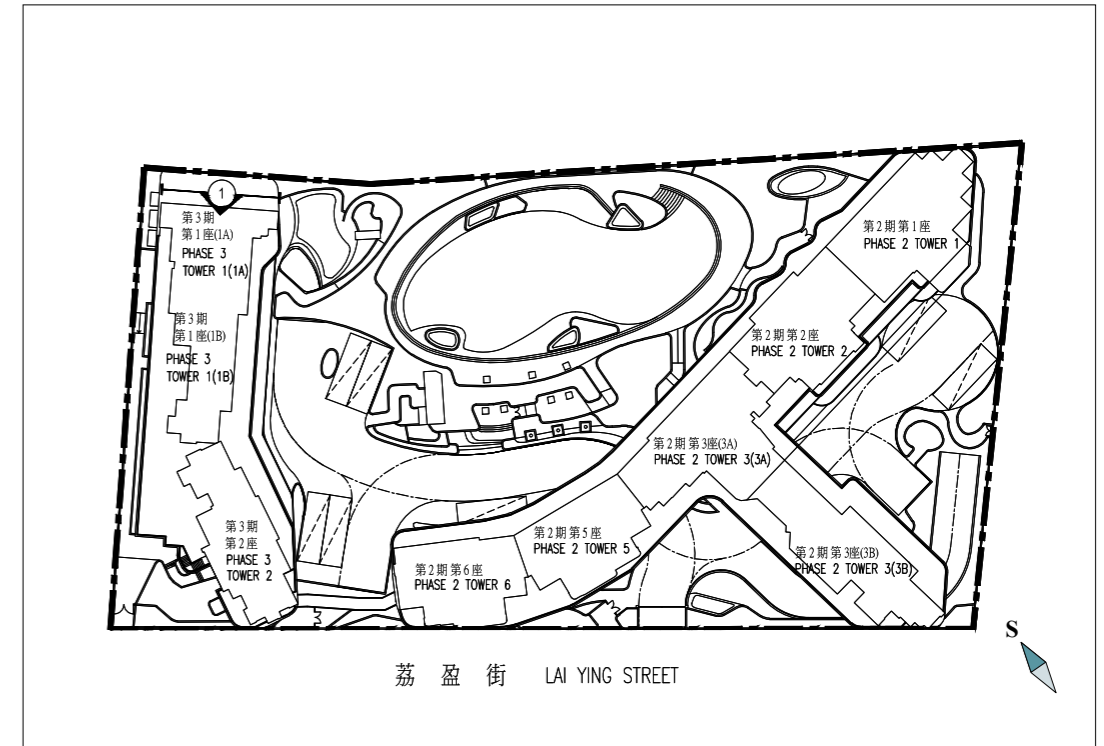

Boundary line of the Development

發展項目的界線

Authorized Person for the Phase certified that the elevations shown on these plans:

1. are prepared on the basis of the approved building plans for the Phase as of 25 November 2020; and
2. are in general accordance with the outward appearance of the Phase.

期數的認可人士證明本圖所顯示的立面：

1. 以2020年11月25日的情況為準的期數的經批准的建築圖則為基礎擬備；及
2. 大致上與期數的外觀一致。

Elevation 2
立面圖 2

Phase 3 Tower 1(1B)
第3期 第1座(1B)

Phase 3 Tower 1(1A)
第3期 第1座(1A)

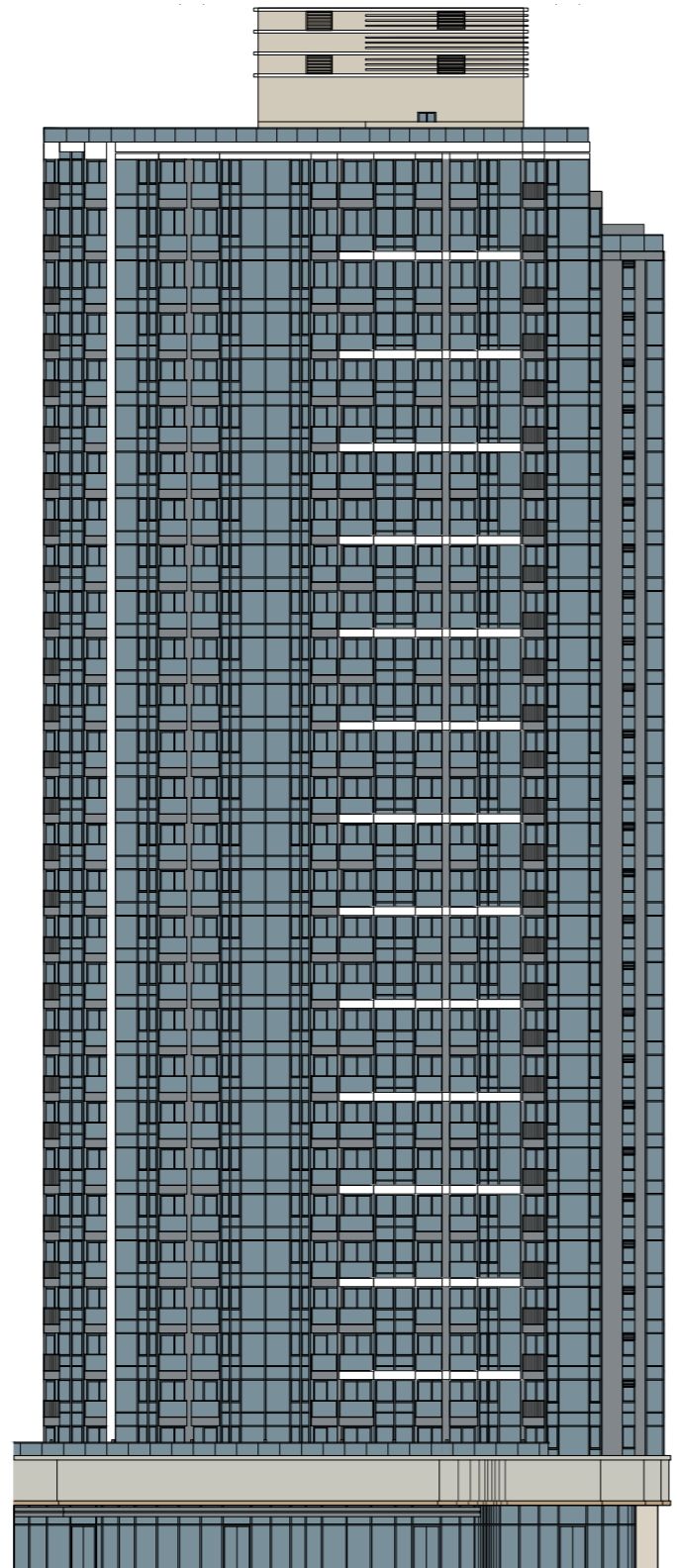

Key Plan
索引圖

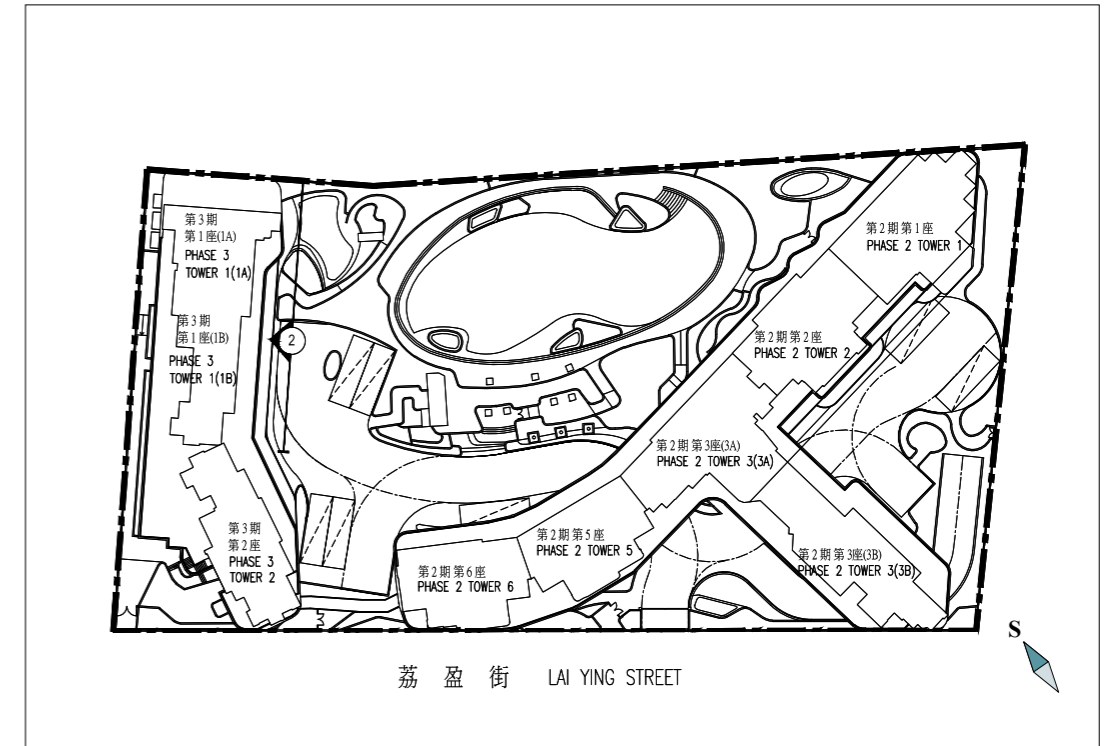

Boundary line of the Development

發展項目的界線

Authorized Person for the Phase certified that the elevations shown on these plans:

1. are prepared on the basis of the approved building plans for the Phase as of 25 November 2020; and
2. are in general accordance with the outward appearance of the Phase.

期數的認可人士證明本圖所顯示的立面：

1. 以2020年11月25日的情況為準的期數的經批准的建築圖則為基礎擬備；及
2. 大致上與期數的外觀一致。

Elevation 3
立面圖 3

Phase 3 Tower 1(1A)
第3期 第1座(1A)

Phase 3 Tower 1(1B)
第3期 第1座(1B)

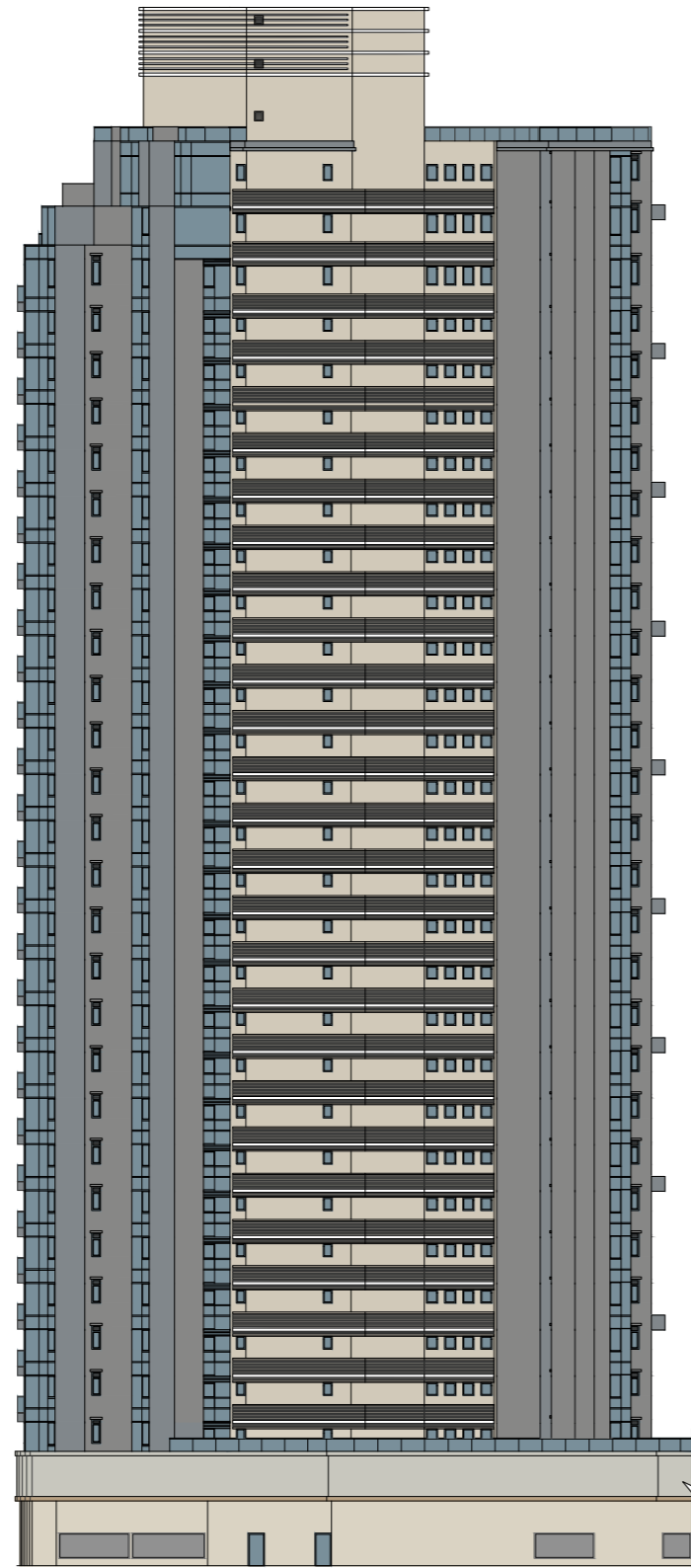

Key Plan
索引圖

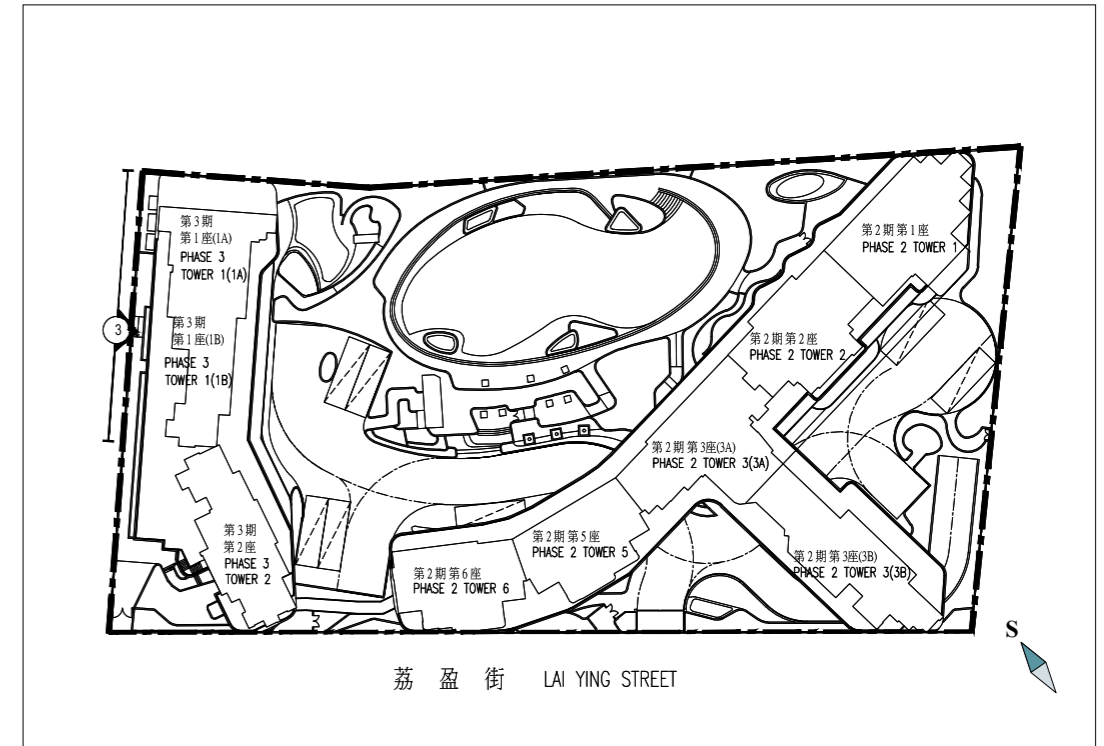

Boundary line of the Development

發展項目的界線

Authorized Person for the Phase certified that the elevations shown on these plans:

1. are prepared on the basis of the approved building plans for the Phase as of 25 November 2020; and
2. are in general accordance with the outward appearance of the Phase.

期數的認可人士證明本圖所顯示的立面：

1. 以2020年11月25日的情況為準的期數的經批准的建築圖則為基礎擬備；及
2. 大致上與期數的外觀一致。

Elevation 4
立面圖 4

Phase 3 Tower 2
第3期 第2座



Key Plan
索引圖

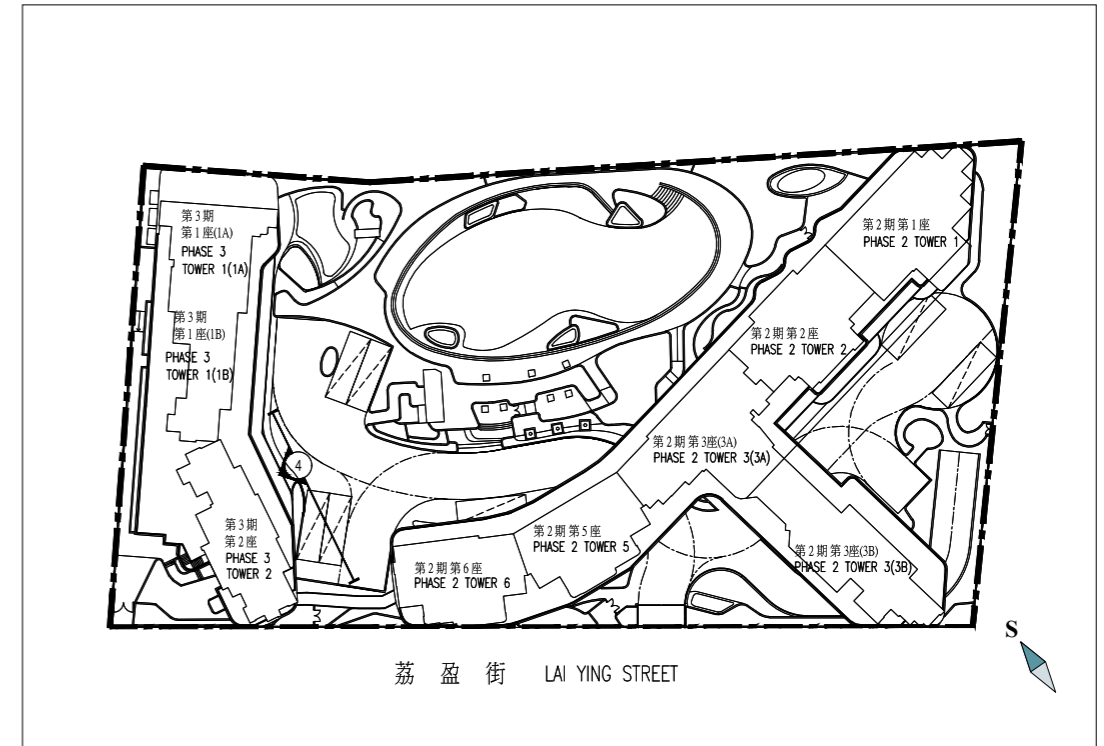

Boundary line of the Development

發展項目的界線

- Authorized Person for the Phase certified that the elevations shown on these plans:
1. are prepared on the basis of the approved building plans for the Phase as of 25 November 2020; and
 2. are in general accordance with the outward appearance of the Phase.

期數的認可人士證明本圖所顯示的立面：

1. 以2020年11月25日的情況為準的期數的經批准的建築圖則為基礎擬備；及
2. 大致上與期數的外觀一致。

Elevation 5
立面圖 5



Phase 3 Tower 2
第3期 第2座

Key Plan
索引圖

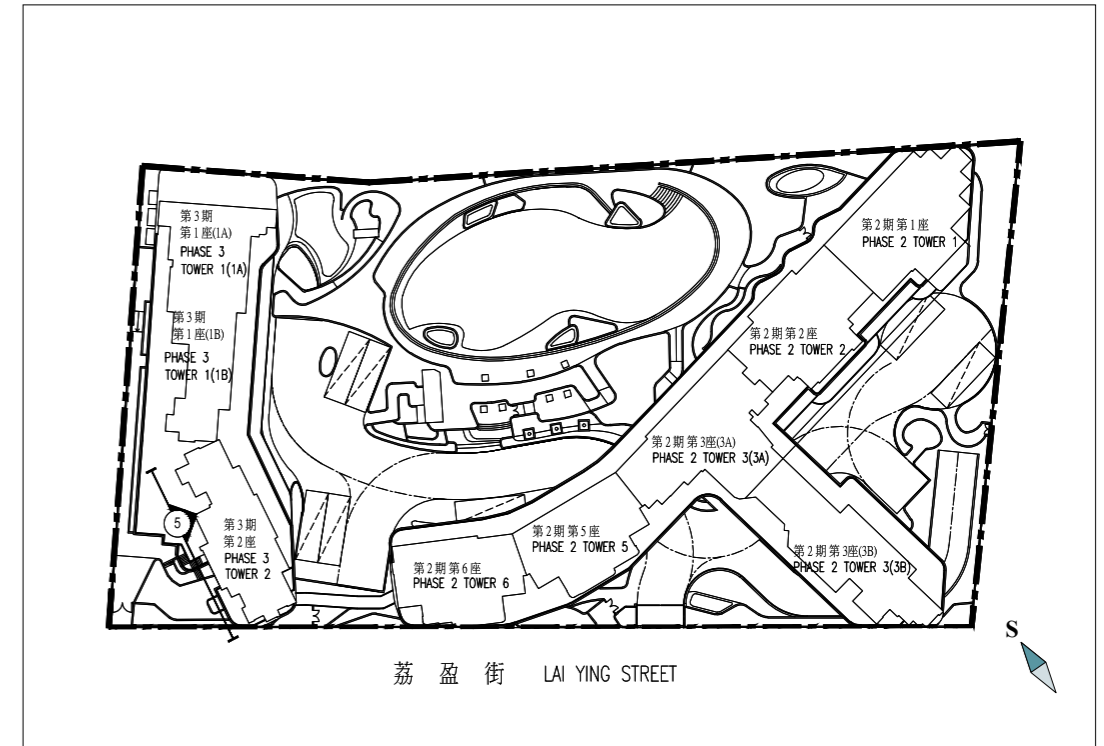

Boundary line of the Development

發展項目的界線

- Authorized Person for the Phase certified that the elevations shown on these plans:
1. are prepared on the basis of the approved building plans for the Phase as of 25 November 2020; and
 2. are in general accordance with the outward appearance of the Phase.

期數的認可人士證明本圖所顯示的立面：

1. 以2020年11月25日的情況為準的期數的經批准的建築圖則為基礎擬備；及
2. 大致上與期數的外觀一致。

Elevation 6
立面圖 6

Phase 3 Tower 2
第3期 第2座



Key Plan
索引圖

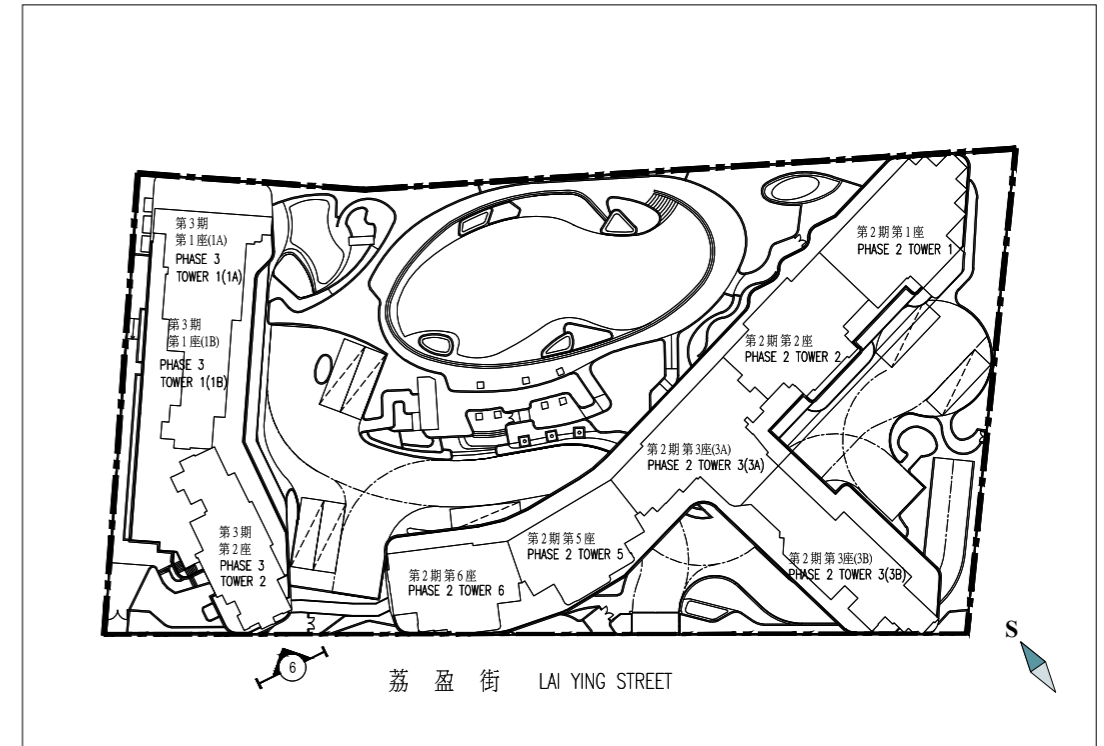

Boundary line of the Development

發展項目的界線

- Authorized Person for the Phase certified that the elevations shown on these plans:
1. are prepared on the basis of the approved building plans for the Phase as of 25 November 2020; and
 2. are in general accordance with the outward appearance of the Phase.

期數的認可人士證明本圖所顯示的立面：

1. 以2020年11月25日的情況為準的期數的經批准的建築圖則為基礎擬備；及
2. 大致上與期數的外觀一致。

	Covered Area 有蓋範圍		Uncovered Area 無蓋範圍		Total 總數	
	Area (sq.m.) 面積 (平方米)	Area (sq.ft.) 面積 (平方呎)	Area (sq.m.) 面積 (平方米)	Area (sq.ft.) 面積 (平方呎)	Area (sq.m.) 面積 (平方米)	Area (sq.ft.) 面積 (平方呎)
Residents' clubhouse (including any recreational facilities for residents' use) 住客會所 (包括供住客使用的任何康樂設施)	N/A 不適用	N/A 不適用	N/A 不適用	N/A 不適用	N/A 不適用	N/A 不適用
Communal garden or play area for residents' use on the roof, or on any floor between the roof and the lowest residential floor, of a building in the Phase (whether known as a communal sky garden or otherwise) 位於期數中的建築物的天台或在天台和最低一層住宅樓層之間的任何一層的、供住客使用的公用花園或遊樂地方 (不論是稱為公用空中花園或有其他名稱)	N/A 不適用	N/A 不適用	N/A 不適用	N/A 不適用	N/A 不適用	N/A 不適用
Communal garden or play area for residents' use below the lowest residential floor of a building in the Phase (whether known as a covered and landscaped play area or otherwise) 位於期數中的建築物的最低一層住宅樓層以下的、供住客使用的公用花園或遊樂地方 (不論是稱為有蓋及園景的遊樂場或有其他名稱)	N/A 不適用	N/A 不適用	N/A 不適用	N/A 不適用	N/A 不適用	N/A 不適用

Remark:

The area as specified above in square feet are converted from the area in square metre at a rate of 1 square metre = 10.764 square feet and rounded to the nearest whole square foot, which may be slightly different from the area presented in square metres.

附註：

上述以平方呎表述之面積由以平方米表述之面積以1平方米=10.764平方呎換算並四捨五入至整數平方呎之方法計算得出，與以平方米表述之面積可能有些微差異。

- Copies of the outline zoning plan relating to the Development are available at www.ozp.tpb.gov.hk.
- (a) A copy of the latest draft of every deed of mutual covenant in respect of the specified residential properties as at the date on which the specified residential properties are offered to be sold is available for inspection at the place at which the specified residential properties are offered to be sold.
- (b) The inspection is free of charge.

- 備有關於發展項目的分區計劃大綱圖的文本供閱覽的互聯網網站的網址為 www.ozp.tpb.gov.hk。
- (a) 指明住宅物業的每一公契在將指明住宅物業提供出售的日期的最新擬稿的文本存放在指明住宅物業的售樓處，以供閱覽。
- (b) 無須為閱覽付費。

1. Exterior Finishes

Item	Descriptions		
a. External wall	Type of finishes	Façade of residential towers finished with tiles, curtain wall, glass cladding, stone cladding, metal cladding, louver and grille Transfer plate finished with stone cladding Podium finished with glass wall, glass cladding, stone cladding, metal cladding, louvers and grille	
b. Window	Material of frame	Fluorocarbon coated aluminum frame	
	Material of glass	Clear glass for living room, dining room, bedroom, kitchen, store and utility room in all units; master bathroom of Unit A of 1/F-3/F, 5/F-12/F, 15/F-23/F, 25/F-30/F of Phase 3 Tower 1(1A) and master bathroom of Unit A & B of 31/F-32/F of Phase 3 Tower 1(1A) Obscure glass for bathroom and rest room in all units, except for master bathroom of Unit A of 1/F-3/F, 5/F-12/F, 15/F-23/F, 25/F-30/F of Phase 3 Tower 1(1A) and master bathroom of Unit A & B of 31/F-32/F of Phase 3 Tower 1(1A)	
c. Bay window	Material of bay window	No bay window	
	Finishes of window sill	No bay window sill	
d. Planter	Type of finishes	No planter	
e. Verandah or Balcony	(i) Type of finishes	Balcony	Glass balustrade with aluminium posts and top rail
		Balcony floor	Tiles
		Balcony wall	Aluminium cladding and tiles
		Balcony ceiling	Aluminium panel
		Verandah	No verandah
		(ii) Whether it is covered	Balcony
	Verandah	No verandah	
	f. Drying facilities for clothing	Type	No drying facilities
Material		No drying facilities	

1. 外部裝修物料

細項	描述		
a. 外牆	裝修物料的類型	住宅大樓外牆鋪砌瓷磚、幕牆、玻璃蓋板、石蓋板、金屬蓋板、百葉及裝飾架 轉換層鋪砌石蓋板 平台鋪砌玻璃牆、玻璃蓋板、石蓋板、金屬蓋板、百葉及裝飾架	
b. 窗	框的用料	氟化碳塗鋁框	
	玻璃的用料	清玻璃於所有單位之客廳、飯廳、睡房、廚房、儲物房及多功能房；第3期第1座(1A) 1樓至3樓、5樓至12樓、15樓至23樓、25樓至30樓A單位之主人浴室及第3期第1座(1A) 31樓至32樓A及B單位之主人浴室 磨砂玻璃於所有單位之浴室及洗手間，不包括第3期第1座(1A) 1樓至3樓、5樓至12樓、15樓至23樓、25樓至30樓A單位之主人浴室及第3期第1座(1A) 31樓至32樓A及B單位之主人浴室	
c. 窗台	窗台的用料	沒有窗台	
	窗台板的裝修物料	沒有窗台板	
d. 花槽	裝修物料的類型	沒有花槽	
e. 陽台或露台	(i) 裝修物料的類型	露台	玻璃欄杆配以鋁質企柱及頂欄
		露台地台	瓷磚
		露台外牆	鋁質蓋板及瓷磚
		露台天花	鋁質板
		陽台	沒有陽台
	(ii) 是否有蓋	露台	有
		陽台	沒有陽台
f. 乾衣設施	類型	沒有乾衣設施	
	用料	沒有乾衣設施	

2. Interior Finishes

Item	Descriptions	Type of wall finishes		
		Type of wall finishes	Type of floor finishes	Type of ceiling finishes
a. Lobby	Residential Lift Lobby at B2/F, B1/F	Natural stone on the exposed surface	Natural stone on the exposed surface	Gypsum board false ceiling with emulsion paint on the exposed surface
	Residential Entrance Lift Lobby at G/F	Natural stone, wallcovering, mirror, metal and plastic laminate on the exposed surface	Natural stone on the exposed surface	Gypsum board false ceiling with emulsion paint and mirror on the exposed surface
	Residential Typical Floor private Lift Lobby in Phase 3 Tower 1(1A) (except for 31/F in Phase 3 Tower 1(1A))	Natural stone, glass, metal and timber on the exposed surface	Natural stone and tile on the exposed surface	Gypsum board false ceiling with emulsion paint and metal on the exposed surface
	Residential Typical Floor Lift Lobby in Phase 3 Tower 1(1B), Phase 3 Tower 2	Natural stone, glass, metal and timber on the exposed surface	Natural stone and tile on the exposed surface	Gypsum board false ceiling with emulsion paint and metal on the exposed surface
	Private Lift Lobby at 31/F in Phase 3 Tower 1(1A)	Natural stone, metal and timber on the exposed surface	Natural stone and tile on the exposed surface	Gypsum board false ceiling with emulsion paint and metal on the exposed surface

2. 室內裝修物料

細項	描述	Type of wall finishes		
		牆壁的裝修物料 的類型	地板的裝修物料 的類型	天花板的裝修物料 的類型
a. 大堂	地庫2層、地庫1層住宅升降機大堂	外露位置鋪砌天然石材	外露位置鋪砌天然石材	外露位置裝設石膏板假天花髹乳膠漆
	地下住宅入口升降機大堂	外露位置鋪砌天然石材、牆布、鏡、金屬及膠板	外露位置鋪砌天然石材	外露位置裝設石膏板假天花髹乳膠漆及鋪砌鏡
	第3期第1座(1A)住宅標準層私人升降機大堂 (第3期第1座(1A) 31樓除外)	外露位置鋪砌天然石材、玻璃、金屬及木	外露位置鋪砌天然石材和瓷磚	外露位置裝設石膏板假天花髹乳膠漆及鋪砌金屬
	第3期第1座(1B)、第3期第2座住宅標準層升降機大堂	外露位置鋪砌天然石材、玻璃、金屬及木	外露位置鋪砌天然石材和瓷磚	外露位置裝設石膏板假天花髹乳膠漆及鋪砌金屬
	第3期第1座(1A) 31樓之私人升降機大堂	外露位置鋪砌天然石材、金屬及木	外露位置鋪砌天然石材和瓷磚	外露位置裝設石膏板假天花髹乳膠漆及鋪砌金屬

2. Interior Finishes

Item	Descriptions	Type of wall finishes	Type of ceiling finishes
b. Internal wall and ceiling	All living room and dining room (except specified below)	Emulsion paint on the exposed surface	Emulsion paint on gypsum board bulkhead and the exposed surface
	Living room and dining room of the following units: Phase 3 Tower 1(1B): Units B, C & D on 1/F-3/F, 5/F-12/F, 15/F-23/F & 25/F-32/F Phase 3 Tower 1(1B): Unit G on 1/F-3/F, 5/F-12/F, 15/F-23/F & 25/F-30/F Phase 3 Tower 2: Units B, C & D on 1/F-3/F, 5/F-12/F, 15/F-23/F & 25/F-32/F	Timber and emulsion paint on the exposed surface	Emulsion paint on gypsum board bulkhead and the exposed surface
	All bedrooms	Emulsion paint on the exposed surface	Emulsion paint on gypsum board bulkhead and the exposed surface
		Material of floor	Material of skirting
c. Internal floor	All living room and dining room	Timber and reconstituted stone border adjoining balcony, utility platform and open kitchen on the exposed surface	Timber
	All bedrooms	Timber and reconstituted stone border adjoining utility platform on the exposed surface	Timber

2. 室內裝修物料

細項	描述	牆壁的裝修物料的類型	天花板的裝修物料的類型
b. 內牆及天花板	所有客廳及飯廳 (以下指定除外)	外露位置髹乳膠漆	石膏板假樑及外露位置髹乳膠漆
	以下單位之客廳及飯廳： 第3期第1座(1B)：1樓至3樓、5樓至12樓、15樓至23樓及25樓至32樓之B、C及D單位 第3期第1座(1B)：1樓至3樓、5樓至12樓、15樓至23樓及25樓至30樓之G單位 第3期第2座：1樓至3樓、5樓至12樓、15樓至23樓及25樓至32樓之B、C及D單位	外露位置鋪砌木及髹乳膠漆	石膏板假樑及外露位置髹乳膠漆
	所有睡房	外露位置髹乳膠漆	石膏板假樑及外露位置髹乳膠漆
		地板的用料	牆腳線的用料
c. 內部地板	所有客廳及飯廳	外露位置鋪砌木及人造石邊緣於連接露台、工作平台處及開放式廚房	木
	所有睡房	外露位置鋪砌木及人造石邊緣於連接工作平台處	木

2. Interior Finishes

Item	Descriptions				
		Wall	Floor	Ceiling	
d. Bathroom	(i) Type of finishes	All bathrooms (except specified below)	Tile, metal and glass on exposed surface; tile and natural stone for shower cubicle	Tile on exposed surface; natural stone for shower cubicle	Gypsum board false ceiling with emulsion paint and metal false ceiling on exposed surface
		All bathrooms of the following units: Phase 3 Tower 1(1A): Unit A & B on 31/F to 32/F	Natural stone, glass and metal on the exposed surface	Natural stone on the exposed surface	Gypsum board false ceiling with emulsion paint and metal false ceiling on the exposed surface
		Rest room	Tile on exposed surface	Tile on exposed surface	Metal false ceiling on the exposed surface
	(ii) Whether the wall finishes run up to the ceiling	Wall finishes run up to false ceiling			
e. Kitchen	(i) Type of finishes	Tile on exposed surface	For all kitchens (except open kitchens): Tile on exposed surface	For all kitchens (except open kitchens): Gypsum board false ceiling with emulsion paint and metal false ceiling on exposed surface	Solid surfacing
			For open kitchens: Reconstituted stone border on exposed surface	For open kitchens: Gypsum board false ceiling with emulsion paint on exposed surface	
	(ii) Whether the wall finishes run up to the ceiling	Wall finishes run up to false ceiling			

2. 室內裝修物料

細項	描述				
		牆壁	地板	天花板	
d. 浴室	(i) 裝修物料的类型	所有浴室 (以下指定除外)	外露位置鋪砌瓷磚、金屬及玻璃；淋浴間鋪砌瓷磚及天然石材	外露位置鋪砌瓷磚；淋浴間鋪砌天然石材	石膏板假天花髹乳膠漆及金屬假天花於外露位置
		以下單位之所有浴室： 第3期第1座(1A)：31樓至32樓之A及B單位	外露位置鋪砌天然石材、玻璃及金屬	外露位置鋪砌天然石材	石膏板假天花髹乳膠漆及金屬假天花於外露位置
		洗手間	外露位置鋪砌瓷磚	外露位置鋪砌瓷磚	金屬假天花於外露位置
	(ii) 牆壁的裝修物料是否鋪至天花板	牆壁的裝修物料鋪至假天花底			
e. 廚房	(i) 裝修物料的类型	外露位置鋪砌瓷磚	所有廚房(開放式廚房除外)： 外露位置鋪砌瓷磚	所有廚房(開放式廚房除外)： 石膏板假天花髹乳膠漆及金屬假天花於外露位置	實體面材
			開放式廚房： 外露位置鋪砌人造石邊緣	開放式廚房： 石膏板假天花髹乳膠漆於外露位置	
	(ii) 牆壁的裝修物料是否鋪至天花板	牆壁的裝修物料鋪至假天花底			

3. Interior Fittings

Item	Descriptions	Material		
		Material	Finishes	Accessories
a. Doors	Main entrance door	Solid core timber door	Timber and metal	Door viewer, door closer, lockset with handle
	Balcony door	Tinted glass door with metal frame	Glass and fluorocarbon coated metal frame	Lockset with handle
	Utility platform door	Tinted glass door with metal frame	Glass and fluorocarbon coated metal frame	Lockset with handle
	Flat roof door	Glass door with metal frame	Glass and fluorocarbon coated metal frame	Lockset with handle
	Bedroom and Store door	Hollow core timber door	Timber	Lockset with handle
	Utility room door	Hollow core timber door	Timber	Lockset with handle
	Bathroom door	All bathrooms and master bathrooms (except bathroom, master bathroom of the units specified below): Hollow core timber door with timber louver Bathroom of the following units: Phase 3 Tower 1(1A): Units B on 1/F-3/F, 5/F-12/F, 15/F-23/F & 25/F-30/F Phase 3 Tower 1(1B): Units A on 1/F-3/F, 5/F-12/F, 15/F-23/F & 25/F-32/F Phase 3 Tower 2: Units A & E on 1/F-3/F, 5/F-12/F, 15/F-23/F & 25/F-32/F Hollow core timber door Master bathroom of the following units: Phase 3 Tower 1(1A): Units A on 1/F-3/F, 5/F-12/F, 15/F-23/F & 25/F-30/F Phase 3 Tower 1(1A): Unit A & B on 31/F-32/F Hollow core timber door	Timber	Lockset with handle

3. 室內裝置

細項	描述	裝修物料		
		用料	裝修物料	配件
a. 門	單位入口大門	實心木門	木及金屬	防盜眼、氣鼓、門鎖連拉手
	露台門	有色玻璃門配金屬框	玻璃及氟碳塗層金屬門框	門鎖連拉手
	工作平台門	有色玻璃門配金屬框	玻璃及氟碳塗層金屬門框	門鎖連拉手
	平台門	玻璃門配金屬框	玻璃及氟碳塗層金屬門框	門鎖連拉手
	睡房及儲物房門	空心木門	木	門鎖連拉手
	多功能房門	空心木門	木	門鎖連拉手
	浴室門	所有浴室及主人浴室(以下指定單位之浴室及主人浴室除外): 空心木門連木百葉 以下單位之浴室: 第3期第1座(1A): 1樓至3樓、5樓至12樓、15樓至23樓及25樓至30樓之B單位 第3期第1座(1B): 1樓至3樓、5樓至12樓、15樓至23樓及25樓至32樓之A單位 第3期第2座: 1樓至3樓、5樓至12樓、15樓至23樓及25樓至32樓之A及E單位 空心木門 以下單位之主人浴室: 第3期第1座(1A): 1樓至3樓、5樓至12樓、15樓至23樓及25樓至30樓之A單位 第3期第1座(1A): 31樓至32樓之A及B單位 空心木門	木	門鎖連拉手

3. Interior Fittings

Item	Descriptions	Material		
		Material	Finishes	Accessories
a. Doors	Kitchen door (except open kitchen)	Fire-rated solid core timber door with fire-rated glass vision panel	Timber	Lockset with handle and door closer
	Rest room door	Glass door with metal frame and metal louver	Obscure glass and metal with powder coating	Lockset
	Lavatory door	Hollow core timber door with timber louver	Timber	Lockset with handle
	Private Lift Lobby door	Fire-rated solid core timber door	Timber	Handle and door closer
	Staircase door	Fire-rated solid core timber door with fire-rated glass vision panel	Timber	Lockset with handle and door closer

3. 室內裝置

細項	描述	Material		
		用料	裝修物料	配件
a. 門	廚房門 (開放式廚房除外)	防火實心木門配防火玻璃視窗	木	門鎖連拉手及氣鼓
	洗手間門	玻璃門配金屬框及金屬百葉	磨砂玻璃及金屬連粉末塗層	門鎖
	衛生間門	空心木門連木百葉	木	門鎖連拉手
	私人升降機大堂門	防火實心木門	木	拉手及氣鼓
	樓梯門	防火實心木門配防火玻璃視窗	木	門鎖連拉手及氣鼓

3. Interior Fittings

Item	Descriptions		
		Type	Material
b. Bathroom	(i) Fittings and equipment	Basin cabinet countertop	Natural stone
		Basin cabinet	Wooden cabinet with plastic laminate and metal
		Mirror cabinet	Wooden cabinet with mirror panel, plastic laminate and metal
		Basin mixer	Metal
		Basin	Ceramic
		Water closet	Ceramic
		Towel bar	Metal
		Hook	Metal
		Paper holder	Metal
		Shower cubicle	Glass with metal frame
		(ii) Water supply system	For type and material of water supply system, please refer to "Water Supply" below
	(iii) Bathing facilities (including shower or bath tub, if applicable)	Shower cubicle	Glass with metal
		Shower set of all units	Metal
		Shower panel of the following units: Phase 3 Tower 1(1A): Unit A & B on 31/F to 32/F	Metal and plastic
		Bath tub	Enamelled pressed steel
	(iv) Size of bath tub (if applicable)	All bath tubs	1500mm(L) x 700mm(W) x 390mm(D)

3. 室內裝置

細項	描述		
		類型	用料
b. 浴室	(i) 裝置及設備	洗手盆櫃枱面	天然石材
		洗手盆櫃	木製櫃配膠板及金屬
		鏡櫃	木製櫃配鏡、膠板及金屬
		洗手盆水龍頭	金屬
		洗手盆	瓷
		坐廁	瓷
		毛巾架	金屬
		鈎	金屬
		廁紙架	金屬
		淋浴間	玻璃配金屬框
		(ii) 供水系統	有關供水系統的類型及用料，請參閱下文「供水」的部份
	(iii) 沐浴設施 (包括花灑或浴缸(如適用))	淋浴間	玻璃及金屬
		所有單位之花灑套裝	金屬
		以下單位之淋浴柱： 第3期第1座(1A)：31樓至32樓之A及B單位	金屬及塑膠
	浴缸	搪瓷鋼板	
(iv) 浴缸大小 (如適用)	所有浴缸	1500毫米(長) x 700毫米(闊) x 390毫米(深)	

3. Interior Fittings

Item	Descriptions		
		Material	
c. Kitchen	(i) Sink unit	Metal	
	(ii) Water supply system	For material of water supply system, please refer to "Water Supply" below	
		Material	Finishes
	(iii) Kitchen cabinet	Wood	Plastic laminate and gloss lacquer door panel surface
		Type	
(iv) All other fittings and equipment	For all kitchen (except open kitchen): Hot and cold water mixer. For all open kitchen: Hot and cold water mixer, sprinkler head(s) (fitted in open kitchen) and smoke detector with a sounder base (fitted in living room and dining room near open kitchen)		
		Type	Material
d. Bedroom	Fittings (including built-in wardrobe)	Not provided	Not provided
e. Telephone	Location and number of connection points	Please refer to the "Schedule of Mechanical & Electrical Provisions of Residential Units"	
f. Aerials	Location and number of connection points	Please refer to the "Schedule of Mechanical & Electrical Provisions of Residential Units"	

3. 室內裝置

細項	描述	用料	
c. 廚房	(i) 洗滌盆	金屬	
	(ii) 供水系統	有關供水系統的用料，請參閱以下「供水」的部份	
		用料	裝修物料
	(iii) 廚櫃	木	膠板及焗漆門板
		類型	
(iv) 所有其他裝置及設備	所有廚房 (開放式廚房除外)：冷熱水龍頭 所有開放式廚房：冷熱水龍頭、消防花灑頭(安裝在開放式廚房內)及設有聲響警報基座的煙霧探測器(安裝在開放式廚房附近的客廳及飯廳內)		
		類型	用料
d. 睡房	裝置 (包括嵌入式衣櫃)	不提供	不提供
e. 電話	接駁點的位置及數目	請參閱「住宅單位機電裝置數量說明表」	
f. 天線	接駁點的位置及數目	請參閱「住宅單位機電裝置數量說明表」	

3. Interior Fittings

Item	Descriptions	
g. Electrical installations	(i) Electrical fittings (including safety devices)	Switch, faceplate for socket and electricity supply board with miniature circuit breakers
	(ii) Whether conduits are concealed or exposed	Conduits are partly concealed and partly exposed Other than those parts of the conduits concealed within concrete, the rest of the conduits are exposed. The exposed conduits may be covered or hidden by false ceilings, bulkheads, cabinets, claddings, non-concrete partition walls, designated pipe ducts or other materials.
	(iii) Location and number of power points and air-conditioner points	Please refer to the "Schedule of Mechanical & Electrical Provisions of Residential Units"
h. Gas supply	Type	Town gas
	System	Town gas connection point is provided. Town gas supply pipes are connected to gas cooker hob (except unit with open kitchen) and to gas water heater which supplies hot water
	Location	For the location of gas water heater, please refer to the "Appliances Schedule"
i. Washing machine connection point	Location	Water supply and drainage connection point are located at kitchens and open kitchens
	Design	Water supply point of a design of 15mm diameter and drainage point of a design of 40mm in diameter
j. Water supply	(i) Material of water pipes	Copper pipes are used for cold and hot water supply UPVC pipes are used for flushing water supply
	(ii) Whether water pipes are concealed or exposed	Water pipes are partly concealed and partly exposed Other than those parts of the water pipes concealed, the rest of the water pipes are exposed. The exposed water pipes may be covered or hidden by false ceilings, bulkheads, cabinets, claddings, non-concrete partition walls, designated pipe ducts or other materials
	(iii) Whether hot water is available	Hot water is available for kitchen, bathroom, rest room and lavatory

3. 室內裝置

細項	描述	
g. 電力裝置	(i) 供電附件 (包括安全裝置)	開關掣、插座之面板及電力配電箱並裝置微型斷路器
	(ii) 導管是隱藏或外露	導管是部分隱藏及部分外露 除部分隱藏於混凝土內之導管外，其他部分的導管均為外露。外露的導管可能被假天花、假樑、貯存櫃、面板、非混凝土間隔牆、指定之管道槽位或其他物料遮蓋或暗藏。
	(iii) 電插座及空調機接駁點的位置及數目	請參閱「住宅單位機電裝置數量說明表」
h. 氣體供應	類型	煤氣
	系統	提供煤氣接駁點 煤氣管道均接駁至煤氣煮食爐（開放式廚房單位除外）及煤氣熱水爐供應
	位置	煤氣熱水爐位置請參閱「設備說明表」
i. 洗衣機接駁點	位置	廚房及開放式廚房設有來去水位
	設計	設計直徑為15毫米的來水接駁喉位及設計直徑為40毫米的去水接駁喉位
j. 供水	(i) 水管的用料	冷熱水喉採用銅喉管 沖廁水喉採用膠喉管
	(ii) 水管是隱藏或外露	水管是部分隱藏及部分外露 除部分隱藏的水管外，其他部分的水管均為外露。外露的水管可能被假天花、假樑、貯存櫃、面板、非混凝土間隔牆、指定之管道槽位或其他物料遮蓋或暗藏
	(iii) 有否熱水供應	廚房、浴室、洗手間及衛生間有熱水供應

4. Miscellaneous

Item	Descriptions			
a. Lifts	(i) Brand name and model number	Brand Name	Hitachi	
		Model Number	MCA-900-CO180, HCA-900-CO/2S180 and MCA-925-CO180	
	(ii) Number and floors served by them	Tower	Number of lift	Floors Served
		Phase 3 Tower 1(1A)	1	B2/F, B1/F, G/F, 1/F-3/F, 5/F-12/F, 15/F-23/F, 25/F-31/F
		Phase 3 Tower 1(1B)	2	One lift serving B2/F, B1/F, G/F, 1/F-3/F, 5/F-12/F, 15/F-23/F, 25/F-32/F One lift serving B2/F, B1/F, G/F, 1/F-3/F, 5/F-12/F, 15/F-23/F, 25/F-32/F & Roof
Phase 3 Tower 2	2	One lift serving B2/F, B1/F, G/F, 2/F-3/F, 5/F-12/F, 15/F-23/F, 25/F-32/F One lift serving B2/F, B1/F, G/F, 2/F-3/F, 5/F-12/F, 15/F-23/F, 25/F-32/F & Roof		
b. Letter box	Material	Metal		
c. Refuse collection	(i) Means of refuse collection	Collected by cleaners from refuse storage and material recovery room		
	(ii) Location of refuse room	Refuse storage and material recovery room is provided in the common area of each residential floor. Refuse storage and material recovery chamber is provided on B1/F.		

In relation to items 4(a) and 6 in the Phase specified in the above table, the Vendor undertakes that if lifts or appliances of the specified brand name or model number are not installed in the Phase, lifts or appliances of comparable quality will be installed.

4. 雜項

細項	描述			
a. 升降機	(i) 品牌名稱及產品型號	品牌名稱	日立	
		產品型號	MCA-900-CO180、HCA-900-CO/2S180及MCA-925-CO180	
	(ii) 升降機的數目及到達的樓層	座數	升降機數目	到達之樓層
		第3期第1座(1A)	1	地庫2層、地庫1層、地下、1樓至3樓、5樓至12樓、15樓至23樓、25樓至31樓
		第3期第1座(1B)	2	一部升降機到達地庫2層、地庫1層、地下、1樓至3樓、5樓至12樓、15樓至23樓、25樓至32樓 一部升降機到達地庫2層、地庫1層、地下、1樓至3樓、5樓至12樓、15樓至23樓、25樓至32樓及天台
第3期第2座	2	一部升降機到達地庫2層、地庫1層、地下、2樓至3樓、5樓至12樓、15樓至23樓、25樓至32樓 一部升降機到達地庫2層、地庫1層、地下、2樓至3樓、5樓至12樓、15樓至23樓、25樓至32樓及天台		
b. 信箱	物料	金屬		
c. 垃圾收集	(i) 垃圾收集的方法	由清潔工人於垃圾及物料回收室收集		
	(ii) 垃圾房的位置	各住宅層之公用地方均設有垃圾及物料回收室；另中央垃圾及物料收集房設於地庫1層。		

有關於期數在上述列表所指明之第4(a)及第6項，賣方承諾如期數中沒有安裝指明的品牌名稱或產品型號的升降機或設備，便會安裝品質相若的升降機或設備。

4. Miscellaneous

Item	Descriptions	Descriptions		
		Water meter	Electricity meter	Gas meter
d. Water meter, electricity meter and gas meter	(i) Location	Inside common water meter cabinet on residential floor	Inside common electrical meter cabinet / room on residential floor	Inside Refuse Storage and Material Recovery Room on residential floor
	(ii) Whether they are separate or communal meters for residential properties	Separate meter	Separate meter	Separate meter

5. Security Facilities

Item	Descriptions
Security system and equipment (including details of built-in provisions and their locations)	<p>CCTV cameras are provided at entrances of the Development, residential entrance lobby of each residential tower, landscaped area, clubhouse, carpark, basement lift lobbies and lift cars and connected to the Management Office.</p> <p>Smart card readers for access control are provided at entrances of the Development, residential entrance lobby of each residential tower, carpark lift lobbies and clubhouse entrance.</p> <p>Each residential unit is equipped a video door-phone which link with a visitor intercom panel at residential entrance lobby of each residential tower.</p>

6. Appliances

Item	Descriptions
Brand name and model number	For brand names and model numbers of appliances provision, please refer to the "Appliances Schedule"

In relation to items 4(a) and 6 in the Phase specified in the above table, the Vendor undertakes that if lifts or appliances of the specified brand name or model number are not installed in the Phase, lifts or appliances of comparable quality will be installed.

4. 雜項

細項	描述	Descriptions		
		水錶	電錶	氣體錶
d. 水錶、電錶及氣體錶	(i) 位置	住宅樓層之公共水錶櫃內	住宅樓層之公共電錶櫃/房內	住宅樓層之垃圾及物料回收室內
	(ii) 就住宅單位而言是獨立抑或公用的錶	獨立錶	獨立錶	獨立錶

5. 保安設施

細項	描述
保安系統及設備 (包括嵌入式的裝備的細節及其位置)	<p>發展項目之入口、每座住宅入口大堂、園景區、會所、停車場、地庫升降機大堂及升降機內均裝設閉路電視接駁到管理處。</p> <p>發展項目之入口、每座住宅入口大堂、停車場升降機大堂及會所入口均裝有智能卡讀卡器以智能卡識別通行。</p> <p>每個住宅單位均裝設視像對講機接駁到每座住宅入口大堂的訪客對講機。</p>

6. 設備

細項	描述
品牌名稱及產品型號	有關設備的品牌名稱及產品型號，請參考「設備說明表」。

有關於期數在上述列表所指明之第4(a)及第6項，賣方承諾如期數中沒有安裝指明的品牌名稱或產品型號的升降機或設備，便會安裝品質相若的升降機或設備。

Appliances Schedule 設備說明表

Location 位置	Appliance 設備	Brand 品牌	Tower 座數	Phase 3 Tower 1(1A) 第3期第1座(1A)					
			Floor 樓層	1/F 1樓		2/F - 3/F, 5/F - 12/F, 15/F - 23/F, 25/F - 30/F 2樓至3樓、5樓至12樓、15樓至23樓、25樓至30樓		31/F - 32/F 31樓至32樓	
			Unit 單位 Model No. 型號	A	B	A	B	A	B
Living Room, Dining Room, Master Ensuite, Ensuite 1, Bedroom, Bedroom 1, Bedroom 2, Bedroom 3, Store, Utility Room, Staircase and Kitchen 客廳、飯廳、 主人套房、套房 1、 睡房、睡房 1、 睡房 2、睡房 3、 儲物房、多功能房、 樓梯及廚房	Variable Refrigerant Volume (VRV) Type Air-Conditioner (Indoor Unit) 變頻多聯式空調機 (室內機)	Daikin 大金	FXAQ25AVM	V	V	V	V	V	V
			FXAQ32AVM	V	V	V	V	V	V
			FXAQ50AVM	V	V	V	V	V	V
			FXDP25QPVC	-	-	-	-	V	V
	Variable Refrigerant Volume (VRV) Type Air-Conditioner (Outdoor Unit) 變頻多聯式空調機 (室外機)	Daikin 大金	RJZQ4AAV	V	V	V	V	V	V
			RJZQ5AAV	-	V	-	V	V	V

The Vendor undertakes that if lifts or appliances of the specified brand name or model number are not installed in the Phase, lifts or appliances of comparable quality will be installed.

Notes :

- 4/F, 13/F, 14/F and 24/F are omitted.
- "V" denotes "Provided".
- "*" denotes "For serving Rest Room".
- "**" denotes "For serving Lavatory".
- "-" denotes "Not provided".

賣方承諾如期數中沒有安裝指明的品牌名稱或產品型號的升降機或設備，便會安裝品質相若的升降機或設備。

附註：

- 不設4樓、13樓、14樓及24樓。
- 「V」代表「提供」。
- 「*」代表「供洗手間之用」。
- 「**」代表「供衛生間之用」。
- 「-」代表「不提供」。

Appliances Schedule 設備說明表

Location 位置	Appliance 設備	Brand 品牌	Tower 座數	Phase 3 Tower 1(1A) 第3期第1座(1A)					
			Floor 樓層	1/F 1樓		2/F - 3/F, 5/F - 12/F, 15/F - 23/F, 25/F - 30/F 2樓至3樓、5樓至12樓、15樓至23樓、25樓至30樓		31/F - 32/F 31樓至32樓	
			Unit 單位 Model No. 型號	A	B	A	B	A	B
Kitchen 廚房	Cooker Hood 抽油煙機	Gaggenau	AF210192	V	V	V	V	V	V
	Gas Hob (1-Burner) 單頭氣體煮食爐	Gaggenau	VG231320HK	V	V	V	V	V	V
	Gas Hob (2-Burners) 雙頭氣體煮食爐		VG232320HK	V	V	V	V	V	V
	Induction Hob (2 Range) 雙頭電磁煮食爐	Gaggenau	VI232120	-	-	-	-	V	V
	Microwave Oven 微波爐	Gaggenau	BMP224110	-	-	-	-	V	V
	Combi-microwave Oven 微波焗爐	Gaggenau	BMP251110	V	-	V	-	-	-
			BMP250110	-	V	-	V	-	-
	Steam Oven 蒸爐	Gaggenau	BSP221111	-	V	-	V	-	-
			BSP220111	V	-	V	-	V	-
	Oven 焗爐	Gaggenau	BOP211112	-	-	-	-	V	-
			BOP210112	-	-	-	-	-	V
	Double Doors Refrigerator 雙門雪櫃	Gaggenau	RB280304	V	V	V	V	-	-
			Sub-Zero	ICBB1-42S	-	-	-	-	V
	Washer Dryer 洗衣乾衣機	Gaggenau	WD200140	V	V	V	V	-	-
	Washing Machine 洗衣機	Gaggenau	WM260164	-	-	-	-	V	V
Dryer 乾衣機	Gaggenau	WT260110	-	-	-	-	V	V	
Wine Storage 酒櫃	Sub-Zero	ICBUW-24	-	-	-	-	V	V	
Coffee Machine 咖啡機	Gaggenau	CMP250112	-	-	-	-	V	V	

The Vendor undertakes that if lifts or appliances of the specified brand name or model number are not installed in the Phase, lifts or appliances of comparable quality will be installed.

Notes :

- 4/F, 13/F, 14/F and 24/F are omitted.
- "V" denotes "Provided".
- "*" denotes "For serving Rest Room".
- "**" denotes "For serving Lavatory".
- "-" denotes "Not provided".

賣方承諾如期數中沒有安裝指明的品牌名稱或產品型號的升降機或設備，便會安裝品質相若的升降機或設備。

附註：

- 不設4樓、13樓、14樓及24樓。
- 「V」代表「提供」。
- 「*」代表「供洗手間之用」。
- 「**」代表「供衛生間之用」。
- 「-」代表「不提供」。

Appliances Schedule 設備說明表

Location 位置	Appliance 設備	Brand 品牌	Tower 座數	Phase 3 Tower 1(1A) 第3期第1座(1A)					
			Floor 樓層	1/F 1樓		2/F - 3/F, 5/F - 12/F, 15/F - 23/F, 25/F - 30/F 2樓至3樓、5樓至12樓、15樓至23樓、25樓至30樓		31/F - 32/F 31樓至32樓	
			Unit 單位 Model No. 型號	A	B	A	B	A	B
Kitchen 廚房	Dishwasher 洗碗碟機	Gaggenau	DF480100	-	-	-	-	V	V
	Warming Drawer 暖碟機	Gaggenau	WSP221110	-	-	-	-	V	V
	Ventilation Fan 抽氣扇	Gelec	DPT15-34H	V	V	V	V	V	V
				V*	V*	V*	V*	V*	V*
				-	-	-	-	V**	-
Gas Water Heater 煤氣熱水爐	TGC	TNJW221TFQL	V	V	V	V	V	-	
Master Bathroom 主人浴室	Ventilation Fan 抽氣扇	Gelec	DPT15-34H	V	V	V	V	V	V
	Thermo Ventilator 浴室寶	Panasonic	FV-40BE3H2	V	V	V	V	V	V
	Gas Water Heater 煤氣熱水爐	TGC	TNJW221TFQL	-	-	-	-	-	V
Bathroom 浴室	Ventilation Fan 抽氣扇	Gelec	DPT15-34H	V	V	V	V	V	V
	Thermo Ventilator 浴室寶	Panasonic	FV-40BE3H2	V	V	V	V	V	V
Bathroom 1 浴室 1	Ventilation Fan 抽氣扇	Gelec	DPT15-34H	-	-	-	-	V	-
	Thermo Ventilator 浴室寶	Panasonic	FV-40BE3H2	-	-	-	-	V	-

The Vendor undertakes that if lifts or appliances of the specified brand name or model number are not installed in the Phase, lifts or appliances of comparable quality will be installed.

Notes :

- 4/F, 13/F, 14/F and 24/F are omitted.
- "V" denotes "Provided".
- "*" denotes "For serving Rest Room".
- "**" denotes "For serving Lavatory".
- "-" denotes "Not provided".

賣方承諾如期數中沒有安裝指明的品牌名稱或產品型號的升降機或設備，便會安裝品質相若的升降機或設備。

附註：

- 不設4樓、13樓、14樓及24樓。
- 「V」代表「提供」。
- 「*」代表「供洗手間之用」。
- 「**」代表「供衛生間之用」。
- 「-」代表「不提供」。

Appliances Schedule 設備說明表

Location 位置	Appliance 設備	Brand 品牌	Tower 座數	Phase 3 Tower 1(1B) 第3期第1座(1B)																				
			Floor 樓層	1/F 1樓							2/F - 3/F, 5/F - 12/F, 15/F - 23/F, 25/F-30/F 2樓至3樓、5樓至12樓、15樓至23樓、25樓至30樓							31/F - 32/F 31樓至32樓						
			Unit 單位 Model No. 型號	A	B	C	D	E	F	G	A	B	C	D	E	F	G	A	B	C	D	E	F	
Living Room, Dining Room, Master Ensuite, Ensuite 1, Master Bedroom, Bedroom, Bedroom 1, Bedroom 2, Store, Utility Room and Kitchen 客廳、飯廳、 主人套房、套房 1、 主人睡房、 睡房、睡房 1、 睡房 2、儲物房、 多功能房及廚房	Single Split Type Air-Conditioner (Indoor Unit) 分體式空調機 (室內機)	Daikin 大金	FTXS60FVMA8	V	-	-	-	V	V	-	V	-	-	-	V	V	-	V	-	-	-	V	V	
	Multi-Split Type Air-Conditioner (Indoor Unit) 多聯分體式空調機 (室內機)	Daikin 大金	FTXS25EVMA	V	V	V	V	-	-	V	V	V	V	V	-	-	V	V	V	V	V	-	-	
			FTXS35EVMA	V	-	-	-	-	-	-	V	-	-	-	-	-	-	V	-	-	-	-	-	-
			FTXS50FVMA	-	V	V	V	-	-	V	-	V	V	V	-	-	V	-	V	V	V	-	-	-
	Single Split Type Air-Conditioner (Outdoor Unit) 分體式空調機 (室外機)	Daikin 大金	RXS60FVMA	V	-	-	-	V	V	-	V	-	-	-	V	V	-	V	-	-	-	V	V	
Multi-Split Type Air-Conditioner (Outdoor Unit) 多聯分體式空調機 (室外機)	Daikin 大金	3MXS80AA	V	V	V	V	-	-	V	V	V	V	V	-	-	V	V	V	V	V	-	-		

The Vendor undertakes that if lifts or appliances of the specified brand name or model number are not installed in the Phase, lifts or appliances of comparable quality will be installed.

Notes :

- 4/F, 13/F, 14/F and 24/F are omitted.
- "V" denotes "Provided".
- "*" denotes "For serving Rest Room".
- "**" denotes "For serving Lavatory".
- "-" denotes "Not provided".

賣方承諾如期數中沒有安裝指明的品牌名稱或產品型號的升降機或設備，便會安裝品質相若的升降機或設備。

附註：

- 不設4樓、13樓、14樓及24樓。
- 「V」代表「提供」。
- 「*」代表「供洗手間之用」。
- 「**」代表「供衛生間之用」。
- 「-」代表「不提供」。

Appliances Schedule 設備說明表

Location 位置	Appliance 設備	Brand 品牌	Tower 座數	Phase 3 Tower 1(1B) 第3期第1座(1B)																		
			Floor 樓層	1/F 1樓							2/F - 3/F, 5/F - 12/F, 15/F - 23/F, 25/F-30/F 2樓至3樓、5樓至12樓、15樓至23樓、25樓至30樓							31/F - 32/F 31樓至32樓				
			Unit 單位 Model No. 型號	A	B	C	D	E	F	G	A	B	C	D	E	F	G	A	B	C	D	E
Kitchen and Open Kitchen 廚房及 開放式廚房	Cooker Hood 抽油煙機	Gaggenau	AF210162	V	V	V	V	V	V	V	V	V	V	V	V	V	V	V	V	V	V	V
	Induction Hob (4 Range) 四頭電磁煮食爐	Gaggenau	CI262115	V	-	-	-	-	-	-	V	-	-	-	-	-	-	V	-	-	-	-
	Induction Hob (2 Range) 雙頭電磁煮食爐	Gaggenau	VI232120	-	V	V	V	V	V	V	-	V	V	V	V	V	V	-	V	V	V	V
	Combi-steam Oven 蒸焗爐	Gaggenau	BSP251111	-	-	V	-	V	-	-	-	-	V	-	V	-	-	-	-	V	V	-
			BSP250111	V	V	-	V	-	V	V	V	V	V	-	V	-	V	V	V	V	-	V
	Double Doors Refrigerator 雙門雪櫃	Siemens	KI86NAF31K	V	-	-	-	-	-	-	V	-	-	-	-	-	-	V	-	-	-	-
	Single Door Refrigerator 單門雪櫃		KI42LAFF0K	-	V	V	V	V	V	V	-	V	V	V	V	V	V	-	V	V	V	V
	Washer Dryer 洗衣乾衣機	Siemens	WK14D321HK	V	V	V	V	V	V	V	V	V	V	V	V	V	V	V	V	V	V	V
	Ventilation Fan 抽氣扇	Gelec	DPT15-34H	V	-	-	-	-	-	-	V	-	-	-	-	-	-	V	-	-	-	-
Gas Water Heater 煤氣熱水爐	TGC	TNJW161TFQL	V	-	-	-	-	-	-	V	-	-	-	-	-	-	V	-	-	-	-	
Bathroom 浴室	Ventilation Fan 抽氣扇	Gelec	DPT15-34H	V	V	V	V	V	V	V	V	V	V	V	V	V	V	V	V	V	V	
	Thermo Ventilator 浴室寶	Panasonic	FV-40BE3H2	V	V	V	V	V	V	V	V	V	V	V	V	V	V	V	V	V	V	
	Electric Water Heater 電熱水爐	Stiebel Eltron 斯寶亞創	DHB 24 STi	-	V	V	V	V	V	V	-	V	V	V	V	V	-	V	V	V	V	

The Vendor undertakes that if lifts or appliances of the specified brand name or model number are not installed in the Phase, lifts or appliances of comparable quality will be installed.

Notes :

- 4/F, 13/F, 14/F and 24/F are omitted.
- "V" denotes "Provided".
- "*" denotes "For serving Rest Room".
- "**" denotes "For serving Lavatory".
- "-" denotes "Not provided".

賣方承諾如期數中沒有安裝指明的品牌名稱或產品型號的升降機或設備，便會安裝品質相若的升降機或設備。

附註：

- 不設4樓、13樓、14樓及24樓。
- 「V」代表「提供」。
- 「*」代表「供洗手間之用」。
- 「**」代表「供衛生間之用」。
- 「-」代表「不提供」。

Appliances Schedule 設備說明表

Location 位置	Appliance 設備	Brand 品牌	Tower 座數	Phase 3 Tower 2 第3期第2座									
			Floor 樓層	1/F 1樓					2/F - 3/F, 5/F - 12/F, 15/F - 23/F, 25/F - 32/F 2樓至3樓、5樓至12樓、15樓至23樓、25樓至32樓				
			Unit 單位 Model No. 型號	A	B	C	D	E	A	B	C	D	E
Living Room, Dining Room, Master Ensuite, Master Bedroom, Bedroom, Bedroom 1, Bedroom 2, Bedroom 3, Store and Kitchen 客廳、飯廳、 主人套房、主人睡房、 睡房、睡房 1、 睡房 2、睡房 3、 儲物房及廚房	Single Split Type Air-Conditioner (Indoor Unit) 分體式空調機 (室內機)	Daikin 大金	FTXS50FVMA8	V	-	-	-	-	V	-	-	-	-
			FTXS60FVMA8	V	-	V	-	V	V	-	V	-	V
	Multi-Split Type Air-Conditioner (Indoor Unit) 多聯分體式空調機 (室內機)	Daikin 大金	FTXS25EVMA	V	V	V	V	V	V	V	V	V	V
			FTXS35EVMA	-	-	V	-	V	-	-	V	-	V
			FTXS50FVMA	-	V	-	V	-	-	V	-	V	-
	Single Split Type Air-Conditioner (Outdoor Unit) 分體式空調機 (室外機)	Daikin 大金	RXS50FVMA	V	-	-	-	-	V	-	-	-	-
			RXS60FVMA	V	-	V	-	V	V	-	V	-	V
	Multi-Split Type Air-Conditioner (Outdoor Unit) 多聯分體式空調機(室外機)	Daikin 大金	3MXS80AA	V	V	V	V	V	V	V	V	V	V

The Vendor undertakes that if lifts or appliances of the specified brand name or model number are not installed in the Phase, lifts or appliances of comparable quality will be installed.

Notes :

- 4/F, 13/F, 14/F and 24/F are omitted.
- "V" denotes "Provided".
- "*" denotes "For serving Rest Room".
- "**" denotes "For serving Lavatory".
- "-" denotes "Not provided".

賣方承諾如期數中沒有安裝指明的品牌名稱或產品型號的升降機或設備，便會安裝品質相若的升降機或設備。

附註：

- 不設4樓、13樓、14樓及24樓。
- 「V」代表「提供」。
- 「*」代表「供洗手間之用」。
- 「**」代表「供衛生間之用」。
- 「-」代表「不提供」。

Appliances Schedule 設備說明表

Location 位置	Appliance 設備	Brand 品牌	Tower 座數	Phase 3 Tower 2 第3期第2座										
			Floor 樓層	1/F 1樓					2/F - 3/F, 5/F - 12/F, 15/F - 23/F, 25/F - 32/F 2樓至3樓、5樓至12樓、15樓至23樓、25樓至32樓					
			Unit 單位 Model No. 型號	A	B	C	D	E	A	B	C	D	E	
Kitchen and Open Kitchen 廚房及 開放式廚房	Cooker Hood 抽油煙機	Gaggenau	AF210162	V	V	V	V	V	V	V	V	V	V	V
	Induction Hob (4 Range) 四頭電磁煮食爐	Gaggenau	CI262115	V	-	V	-	V	V	V	-	V	-	V
	Induction Hob (2 Range) 雙頭電磁煮食爐	Gaggenau	VI232120	-	V	-	V	-	-	V	-	V	-	-
	Combi-steam Oven 蒸焗爐	Gaggenau	BSP251111	V	-	-	V	V	V	V	-	-	V	V
			BSP250111	-	V	V	-	-	-	V	V	-	-	-
	Double Doors Refrigerator 雙門雪櫃	Siemens	KI86NAF31K	V	-	V	-	V	V	V	-	V	-	V
			KI42LAF0K	-	V	-	V	-	-	V	-	-	V	-
	Washer Dryer 洗衣乾衣機	Siemens	WK14D321HK	V	V	V	V	V	V	V	V	V	V	V
	Ventilation Fan 抽氣扇	Gelec	DPT15-34H	V	-	-	-	V	V	V	-	-	-	V
Gas Water Heater 煤氣熱水爐	TGC	TNJW161TFQL	V	-	-	-	V	V	V	-	-	-	V	
Bathroom 浴室	Ventilation Fan 抽氣扇	Gelec	DPT15-34H	V	V	V	V	V	V	V	V	V	V	V
	Thermo Ventilator 浴室寶	Panasonic	FV-40BE3H2	V	V	V	V	V	V	V	V	V	V	V
	Electric Water Heater 電熱水爐	Stiebel Eltron 斯寶亞創	DHB 24 STi	-	V	V	V	-	-	V	V	V	V	-

The Vendor undertakes that if lifts or appliances of the specified brand name or model number are not installed in the Phase, lifts or appliances of comparable quality will be installed.

Notes :

- 4/F, 13/F, 14/F and 24/F are omitted.
- "V" denotes "Provided".
- "*" denotes "For serving Rest Room".
- "**" denotes "For serving Lavatory".
- "-" denotes "Not provided".

賣方承諾如期數中沒有安裝指明的品牌名稱或產品型號的升降機或設備，便會安裝品質相若的升降機或設備。

附註：

- 不設4樓、13樓、14樓及24樓。
- 「V」代表「提供」。
- 「*」代表「供洗手間之用」。
- 「**」代表「供衛生間之用」。
- 「-」代表「不提供」。

Schedule of Mechanical & Electrical Provisions of Residential Units 住宅單位機電裝置數量說明表

Location 位置	Appliance 設備	Phase 3 Tower 1(1A) 第3期第1座(1A)					
		1/F 1樓		2/F - 3/F, 5/F - 12/F, 15/F - 23/F, 25/F - 30/F 2樓至3樓、5樓至12樓、15樓至23樓、25樓至30樓		31/F - 32/F 31樓至32樓	
		A	B	A	B	A	B
Private Lift Lobby 私人升降機大堂	Door Chime Push Button 門鈴按鈕	1	1	1	1	1	1
	Switch for Air-Conditioner (Indoor Unit) 空調機(室內機)開關掣	1	1	1	1	1	1
	Lighting Point 燈位	4	4	4	4	4	4
Living Room and Dining Room 客廳及飯廳	Switch for Air-Conditioner (Indoor Unit) 空調機(室內機)開關掣	1	1	1	1	3	3
	13A Twin Socket Outlet 13A雙位電插座	2	2	2	2	2	2
	13A Twin Socket Outlet (with USB Port) 雙位電插座(附有USB接口)	2	2	2	2	2	2
	TV & FM Outlet 電視及電台插座	2	2	2	2	2	2
	Telephone Outlet 電話插座	2	2	2	2	2	2
	Switch for Ventilation Fan for Bathroom 浴室抽氣扇開關掣	1	1	1	1	-	-
	Switch for Ventilation Fan for Kitchen 廚房抽氣扇開關掣	1	1	1	1	1	1
	Switch for Ventilation Fan for Lavatory 衛生間抽氣扇開關掣	-	-	-	-	1	1
	Switch for Thermo Ventilator 浴室寶開關掣	1	1	1	1	-	-
	Switch for Gas Water Heater 煤氣熱水爐開關掣	1	1	1	1	2	2
	Video Door Phone 視像對講機	1	1	1	1	1	1
	Lighting Switch 燈掣	12	11	10	10	8	7
	Lighting Point 燈位	6	3	6	3	3	4

The Vendor undertakes that if lifts or appliances of the specified brand name or model number are not installed in the Phase, lift or appliances of comparable quality will be installed.

Notes :

- 4/F, 13/F, 14/F and 24/F are omitted.
- "1, 2," denotes the quantity of such provision(s) provided in the residential unit.
- The quantity of the lighting switch shown in the schedule denotes the quantity of switch button(s).
- "-" denotes "Not Provided".

賣方承諾如期數中沒有安裝指明的品牌名稱或產品型號的升降機或設備，便會安裝品質相約的升降機或設備。

附註：

- 不設4樓、13樓、14樓及24樓。
- 「1, 2,"表示提供於該住宅單位內的裝置數量。
- 說明表所顯示的燈掣數量是表示燈掣按鈕的數量。
- 「-」代表「不提供」。

Schedule of Mechanical & Electrical Provisions of Residential Units 住宅單位機電裝置數量說明表

Location 位置	Appliance 設備	Phase 3 Tower 1(1A) 第3期第1座(1A)					
		1/F 1樓		2/F - 3/F, 5/F - 12/F, 15/F - 23/F, 25/F - 30/F 2樓至3樓、5樓至12樓、15樓至23樓、25樓至30樓		31/F - 32/F 31樓至32樓	
		A	B	A	B	A	B
Master Ensuite 主人套房	Switch for Air-Conditioner (Indoor Unit) 空調機(室內機)開關掣	1	1	1	1	2	2
	13A Twin Socket Outlet 13A雙位電插座	1	1	1	1	1	1
	13A Twin Socket Outlet (with USB Port) 13A雙位電插座(附有USB接口)	1	1	1	1	1	1
	TV & FM Outlet 電視及電台插座	1	1	1	1	1	1
	Telephone Outlet 電話插座	1	1	1	1	1	1
	Switch for Ventilation Fan 抽氣扇開關掣	1	1	1	1	1	1
	Switch for Thermo Ventilator 浴室寶開關掣	1	1	1	1	1	1
	Lighting Switch 燈掣	3	6	3	5	3	3
	Lighting Point 燈位	1	2	1	2	1	1
Ensuite 1 套房 1	Switch for Air-Conditioner (Indoor Unit) 空調機(室內機)開關掣	-	-	-	-	1	-
	13A Twin Socket Outlet 13A雙位電插座	-	-	-	-	2	-
	TV & FM Outlet 電視及電台插座	-	-	-	-	1	-
	Telephone Outlet 電話插座	-	-	-	-	1	-
	Switch for Ventilation Fan 抽氣扇開關掣	-	-	-	-	1	-
	Switch for Thermo Ventilator 浴室寶開關掣	-	-	-	-	1	-
	Lighting Switch 燈掣	-	-	-	-	3	-
	Lighting Point 燈位	-	-	-	-	1	-
Bedroom 1 睡房 1	Switch for Air-Conditioner (Indoor Unit) 空調機(室內機)開關掣	1	1	1	1	1	1
	13A Twin Socket Outlet 13A雙位電插座	2	2	2	2	2	2
	TV & FM Outlet 電視及電台插座	1	1	1	1	1	1
	Telephone Outlet 電話插座	1	1	1	1	1	1
	Lighting Switch 燈掣	1	1	1	1	1	1
	Lighting Point 燈位	1	1	1	1	1	1

The Vendor undertakes that if lifts or appliances of the specified brand name or model number are not installed in the Phase, lift or appliances of comparable quality will be installed.

Notes :

- 4/F, 13/F, 14/F and 24/F are omitted.
- "1, 2," denotes the quantity of such provision(s) provided in the residential unit.
- The quantity of the lighting switch shown in the schedule denotes the quantity of switch button(s).
- "-" denotes "Not Provided".

賣方承諾如期數中沒有安裝指明的品牌名稱或產品型號的升降機或設備，便會安裝品質相約的升降機或設備。

附註：

- 不設4樓、13樓、14樓及24樓。
- 「1, 2,"表示提供於該住宅單位內的裝置數量。
- 說明表所顯示的燈掣數量是表示燈掣按鈕的數量。
- 「-」代表「不提供」。

Schedule of Mechanical & Electrical Provisions of Residential Units 住宅單位機電裝置數量說明表

Location 位置	Appliance 設備	Phase 3 Tower 1(1A) 第3期第1座(1A)					
		1/F 1樓		2/F - 3/F, 5/F - 12/F, 15/F - 23/F, 25/F - 30/F 2樓至3樓、5樓至12樓、15樓至23樓、25樓至30樓		31/F - 32/F 31樓至32樓	
		A	B	A	B	A	B
Bedroom 2 睡房 2	Switch for Air-Conditioner (Indoor Unit) 空調機(室內機)開關掣	1	1	1	1	1	1
	13A Twin Socket Outlet 13A雙位電插座	2	2	2	2	2	2
	TV & FM Outlet 電視及電台插座	1	1	1	1	1	1
	Telephone Outlet 電話插座	1	1	1	1	1	1
	Lighting Switch 燈掣	1	2	1	1	1	1
	Lighting Point 燈位	1	1	1	1	1	1
Bedroom 3 睡房 3	Switch for Air-Conditioner (Indoor Unit) 空調機(室內機)開關掣	-	-	-	-	-	1
	13A Twin Socket Outlet 13A雙位電插座	-	-	-	-	-	2
	TV & FM Outlet 電視及電台插座	-	-	-	-	-	1
	Telephone Outlet 電話插座	-	-	-	-	-	1
	Lighting Switch 燈掣	-	-	-	-	-	1
	Lighting Point 燈位	-	-	-	-	-	1
Master Bathroom 主人浴室	13A Single Socket Outlet 13A單位電插座	2	2	2	2	2	2
	Connection Point for Cabinet Light 櫃燈接線位	1	1	1	1	1	1
	Connection Point for Ventilation Fan 抽氣扇接線位	1	1	1	1	1	1
	Connection Point for Thermo Ventilator 浴室寶接線位	1	1	1	1	1	1
	Gas Water Heater Remote Control 煤氣熱水爐溫度控制	1	1	1	1	1	1
	Lighting Point 燈位	5	5	5	5	6	6
Bathroom 浴室	13A Single Socket Outlet 13A單位電插座	2	2	2	2	2	2
	Connection Point for Cabinet Light 櫃燈接線位	1	1	1	1	1	1
	Connection Point for Ventilation Fan 抽氣扇接線位	1	1	1	1	1	1
	Connection Point for Thermo Ventilator 浴室寶接線位	1	1	1	1	1	1
	Gas Water Heater Remote Control 煤氣熱水爐溫度控制	1	1	1	1	1	1
	Lighting Point 燈位	5	5	5	5	5	5

The Vendor undertakes that if lifts or appliances of the specified brand name or model number are not installed in the Phase, lift or appliances of comparable quality will be installed.

Notes :

- 4/F, 13/F, 14/F and 24/F are omitted.
- "1, 2," denotes the quantity of such provision(s) provided in the residential unit.
- The quantity of the lighting switch shown in the schedule denotes the quantity of switch button(s).
- "-" denotes "Not Provided".

賣方承諾如期數中沒有安裝指明的品牌名稱或產品型號的升降機或設備，便會安裝品質相約的升降機或設備。

附註：

- 不設4樓、13樓、14樓及24樓。
- 「1, 2,"表示提供於該住宅單位內的裝置數量。
- 說明表所顯示的燈掣數量是表示燈掣按鈕的數量。
- 「-」代表「不提供」。

Schedule of Mechanical & Electrical Provisions of Residential Units 住宅單位機電裝置數量說明表

Location 位置	Appliance 設備	Phase 3 Tower 1(1A) 第3期第1座(1A)					
		1/F 1樓		2/F - 3/F, 5/F - 12/F, 15/F - 23/F, 25/F - 30/F 2樓至3樓、5樓至12樓、15樓至23樓、25樓至30樓		31/F - 32/F 31樓至32樓	
		A	B	A	B	A	B
Bathroom 1 浴室 1	13A Single Socket Outlet 13A單位電插座	-	-	-	-	2	-
	Connection Point for Cabinet Light 櫃燈接線位	-	-	-	-	1	-
	Connection Point for Ventilation Fan 抽氣扇接線位	-	-	-	-	1	-
	Connection Point for Thermo Ventilator 浴室寶接線位	-	-	-	-	1	-
	Gas Water Heater Remote Control 煤氣熱水爐溫度控制	-	-	-	-	1	-
	Lighting Point 燈位	-	-	-	-	5	-
Lavatory 衛生間	Lighting Point 燈位	-	-	-	-	1	-
Corridor 走廊	Switch for Air-Conditioner (Indoor Unit) 空調機(室內機)開關掣	-	-	-	-	1	1
	Connection Point for Ventilation Fan 抽氣扇接線位	-	-	-	-	1	1
	Connection Point for Thermo Ventilator 浴室寶接線位	-	-	-	-	1	1
	Lighting Switch 燈掣	-	-	-	-	5	5
	Lighting Point 燈位	-	-	-	-	3	4
Kitchen and Open Kitchen 廚房及 開放式廚房	Switch for Air-Conditioner (Indoor Unit) 空調機(室內機)開關掣	-	-	-	-	1	1
	Switch for Telecom Equipment 電訊設備開關掣	1	1	1	1	1	1
	Socket Outlet for Telecom Equipment 電訊設備電插座	2	2	2	2	2	2
	Socket Outlet for Cooker Hood 抽油煙機電插座	1	1	1	1	1	1
	Socket Outlet for Refrigerator 雪櫃電插座	1	1	1	1	1	1
	Socket Outlet for Microwave Oven 微波爐電插座	-	-	-	-	1	1
	Socket Outlet for Wine Storage 酒櫃電插座	-	-	-	-	1	1
	Socket Outlet for Coffee Machine 咖啡機電插座	-	-	-	-	1	1
	Socket Outlet for Dishwasher 洗碗碟機電插座	-	-	-	-	1	1
Socket Outlet for Warming Drawer 暖碟機電插座	-	-	-	-	1	1	

The Vendor undertakes that if lifts or appliances of the specified brand name or model number are not installed in the Phase, lift or appliances of comparable quality will be installed.

Notes :

- 4/F, 13/F, 14/F and 24/F are omitted.
- "1, 2," denotes the quantity of such provision(s) provided in the residential unit.
- The quantity of the lighting switch shown in the schedule denotes the quantity of switch button(s).
- "-" denotes "Not Provided".

賣方承諾如期數中沒有安裝指明的品牌名稱或產品型號的升降機或設備，便會安裝品質相約的升降機或設備。

附註：

- 不設4樓、13樓、14樓及24樓。
- 「1, 2,"表示提供於該住宅單位內的裝置數量。
- 說明表所顯示的燈掣數量是表示燈掣按鈕的數量。
- 「-」代表「不提供」。

Schedule of Mechanical & Electrical Provisions of Residential Units 住宅單位機電裝置數量說明表

Location 位置	Appliance 設備	Phase 3 Tower 1(1A) 第3期第1座(1A)					
		1/F 1樓		2/F - 3/F, 5/F - 12/F, 15/F - 23/F, 25/F - 30/F 2樓至3樓、5樓至12樓、15樓至23樓、25樓至30樓		31/F - 32/F 31樓至32樓	
		A	B	A	B	A	B
Kitchen and Open Kitchen 廚房及 開放式廚房	Socket Outlet for Steam Oven 蒸爐電插座	1	1	1	1	1	1
	Socket Outlet for Gas Hob 氣體煮食爐電插座	2	2	2	2	2	2
	Socket Outlet for Washer Dryer 洗衣乾衣機電插座	1	1	1	1	-	-
	Socket Outlet for Washing Machine 洗衣機電插座	-	-	-	-	1	1
	Socket Outlet for Dryer 乾衣機電插座	-	-	-	-	1	1
	13A Twin Socket Outlet 13A雙位電插座	2	2	2	2	2	2
	Connection Point for Cabinet Light 櫃燈接線位	1	1	1	1	1	1
	Connection Point for Ventilation Fan 抽氣扇接線位	2	2	2	2	3	2
	Connection Point for Combi-Microwave Oven 微波焗爐接線位	1	1	1	1	-	-
	Connection Point for Oven 焗爐接線位	-	-	-	-	1	1
	Connection Point for Induction Hob 電磁煮食爐接線位	-	-	-	-	1	1
	Switch for Combi-Microwave Oven 微波焗爐開關掣	1	1	1	1	-	-
	Switch for Oven 焗爐開關掣	-	-	-	-	1	1
	Switch for Induction Hob 電磁煮食爐開關掣	-	-	-	-	1	1
	Connection Point for Gas Water Heater 煤氣熱水爐接線位	1	1	1	1	2	2
	Door Chime 門鈴	1	1	1	1	1	1
	Lighting Switch 燈掣	1	-	1	-	1	-
Lighting Point 燈位	4	4	4	4	4	4	
Store 儲物房	Switch for Air-Conditioner (Indoor Unit) 空調機(室內機)開關掣	-	-	-	-	1	1
	13A Single Socket Outlet 13A單位電插座	-	-	-	-	1	1
	Telephone Outlet 電話插座	-	-	-	-	1	1
	Lighting Switch 燈掣	-	-	-	-	1	1
	Lighting Point 燈位	-	-	-	-	1	1

The Vendor undertakes that if lifts or appliances of the specified brand name or model number are not installed in the Phase, lift or appliances of comparable quality will be installed.

Notes :

- 4/F, 13/F, 14/F and 24/F are omitted.
- "1, 2," denotes the quantity of such provision(s) provided in the residential unit.
- The quantity of the lighting switch shown in the schedule denotes the quantity of switch button(s).
- "-" denotes "Not Provided".

賣方承諾如期數中沒有安裝指明的品牌名稱或產品型號的升降機或設備，便會安裝品質相約的升降機或設備。

附註：

- 不設4樓、13樓、14樓及24樓。
- 「1, 2,"表示提供於該住宅單位內的裝置數量。
- 說明表所顯示的燈掣數量是表示燈掣按鈕的數量。
- 「-」代表「不提供」。

Schedule of Mechanical & Electrical Provisions of Residential Units 住宅單位機電裝置數量說明表

Location 位置	Appliance 設備	Phase 3 Tower 1(1A) 第3期第1座(1A)					
		1/F 1樓		2/F - 3/F, 5/F - 12/F, 15/F - 23/F, 25/F - 30/F 2樓至3樓、5樓至12樓、15樓至23樓、25樓至30樓		31/F - 32/F 31樓至32樓	
		A	B	A	B	A	B
Utility Room 多功能房	Switch for Air-Conditioner (Indoor Unit) 空調機(室內機)開關掣	1	1	1	1	1	1
	13A Single Socket Outlet 13A單位電插座	1	1	1	1	1	1
	Switch for Ventilation Fan 抽氣扇開關掣	1	1	1	1	1	1
	Lighting Switch 燈掣	2	3	2	2	2	2
	Lighting Point 燈位	1	1	1	1	1	1
	Miniature Circuit Breakers Board 總電掣箱	1	1	1	1	1	1
Rest Room 洗手間	Lighting Point 燈位	1	1	1	1	1	1
Internal Staircase 內置樓梯	Lighting Point 燈位	-	-	-	-	9	6
Balcony 露台	Lighting Point 燈位	-	-	1	1	-	-
Utility Platform 工作平台	Lighting Point 燈位	-	-	1	1	-	-
Flat Roof 平台	13A Watertight Socket Outlet 13A防水電插座	-	4	-	-	2	2
	Lighting Point 燈位	4	12	-	-	5	6
Roof 天台	13A Watertight Socket Outlet 13A防水電插座	-	-	-	-	3	3
	Wall Light 牆燈	-	-	-	-	10	12

The Vendor undertakes that if lifts or appliances of the specified brand name or model number are not installed in the Phase, lift or appliances of comparable quality will be installed.

Notes :

- 4/F, 13/F, 14/F and 24/F are omitted.
- "1, 2," denotes the quantity of such provision(s) provided in the residential unit.
- The quantity of the lighting switch shown in the schedule denotes the quantity of switch button(s).
- "-" denotes "Not Provided".

賣方承諾如期數中沒有安裝指明的品牌名稱或產品型號的升降機或設備，便會安裝品質相約的升降機或設備。

附註：

- 不設4樓、13樓、14樓及24樓。
- 「1, 2,"表示提供於該住宅單位內的裝置數量。
- 說明表所顯示的燈掣數量是表示燈掣按鈕的數量。
- 「-」代表「不提供」。

Schedule of Mechanical & Electrical Provisions of Residential Units 住宅單位機電裝置數量說明表

Location 位置	Appliance 設備	Phase 3 Tower 1(1B) 第3期第1座(1B)																			
		1/F 1樓						2/F - 3/F, 5/F - 12/F, 15/F - 23/F, 25/F - 30/F 2樓至3樓、5樓至12樓、15樓至23樓、25樓至30樓						31/F - 32/F 31樓至32樓							
		A	B	C	D	E	F	G	A	B	C	D	E	F	G	A	B	C	D	E	F
Main Entrance 大門入口	Door Chime Push Button 門鈴按鈕	1	1	1	1	1	1	1	1	1	1	1	1	1	1	1	1	1	1	1	1
Living Room and Dining Room 客廳及飯廳	Switch for Air-Conditioner (Indoor Unit) 空調機(室內機)開關掣	1	1	1	1	1	1	1	1	1	1	1	1	1	1	1	1	1	1	1	1
	13A Twin Socket Outlet 13A雙位電插座	2	1	1	1	1	1	1	2	1	1	1	1	1	1	2	1	1	1	1	1
	13A Twin Socket Outlet (with USB Port) 雙位電插座(附有USB接口)	2	2	2	2	2	2	2	2	2	2	2	2	2	2	2	2	2	2	2	2
	TV & FM Outlet 電視及電台插座	2	2	2	2	2	2	2	2	2	2	2	2	2	2	2	2	2	2	2	2
	Telephone Outlet 電話插座	2	2	2	2	2	2	2	2	2	2	2	2	2	2	2	2	2	2	2	2
	Connection Point for Cabinet Light 櫃燈接線位	-	1	1	1	1	1	1	-	1	1	1	1	1	1	-	1	1	1	1	1
	Switch for Ventilation Fan for Bathroom 浴室抽氣扇開關掣	1	1	1	1	1	1	-	1	1	1	1	1	1	-	1	1	1	1	1	1
	Switch for Ventilation Fan for Kitchen 廚房抽氣扇開關掣	1	-	-	-	-	-	-	1	-	-	-	-	-	-	1	-	-	-	-	-
	Switch for Thermo Ventilator 浴室寶開關掣	1	1	1	1	1	1	-	1	1	1	1	1	1	-	1	1	1	1	1	1
	Switch for Gas Water Heater 煤氣熱水爐開關掣	1	-	-	-	-	-	-	1	-	-	-	-	-	-	1	-	-	-	-	-
	Switch for Electric Water Heater 電熱水爐開關掣	-	1	1	1	1	1	-	-	1	1	1	1	1	-	-	1	1	1	1	1
	Video Door Phone 視像對講機	1	1	1	1	1	1	1	1	1	1	1	1	1	1	1	1	1	1	1	1
	Door Chime 門鈴	-	1	1	1	1	1	1	-	1	1	1	1	1	1	-	1	1	1	1	1
	Lighting Switch 燈掣	12	11	11	11	11	11	9	11	10	10	10	10	10	8	11	10	10	10	10	10
Lighting Point 燈位	5	3	3	3	3	3	3	5	3	3	3	3	3	3	5	3	3	3	3	3	

The Vendor undertakes that if lifts or appliances of the specified brand name or model number are not installed in the Phase, lift or appliances of comparable quality will be installed.

Notes :

- 4/F, 13/F, 14/F and 24/F are omitted.
- "1, 2," denotes the quantity of such provision(s) provided in the residential unit.
- The quantity of the lighting switch shown in the schedule denotes the quantity of switch button(s).
- "-" denotes "Not Provided".

賣方承諾如期數中沒有安裝指明的品牌名稱或產品型號的升降機或設備，便會安裝品質相約的升降機或設備。

附註：

- 不設4樓、13樓、14樓及24樓。
- 「1, 2,"表示提供於該住宅單位內的裝置數量。
- 說明表所顯示的燈掣數量是表示燈掣按鈕的數量。
- 「-」代表「不提供」。

Schedule of Mechanical & Electrical Provisions of Residential Units 住宅單位機電裝置數量說明表

Location 位置	Appliance 設備	Phase 3 Tower 1(1B) 第3期第1座(1B)																				
		1/F 1樓							2/F - 3/F, 5/F - 12/F, 15/F - 23/F, 25/F - 30/F 2樓至3樓、5樓至12樓、15樓至23樓、25樓至30樓							31/F - 32/F 31樓至32樓						
		A	B	C	D	E	F	G	A	B	C	D	E	F	G	A	B	C	D	E	F	
Master Ensuite and Master Bedroom 主人套房及 主人睡房	Switch for Air-Conditioner (Indoor Unit) 空調機(室內機)開關掣	1	1	1	1	-	-	1	1	1	1	1	-	-	1	1	1	1	1	-	-	
	13A Twin Socket Outlet 13A雙位電插座	1	1	1	1	-	-	1	1	1	1	1	-	-	1	1	1	1	1	1	-	-
	13A Twin Socket Outlet (with USB Port) 13A雙位電插座(附有USB接口)	1	1	1	1	-	-	1	1	1	1	1	-	-	1	1	1	1	1	1	-	-
	TV & FM Outlet 電視及電台插座	1	1	1	1	-	-	1	1	1	1	1	-	-	1	1	1	1	1	1	-	-
	Telephone Outlet 電話插座	1	1	1	1	-	-	1	1	1	1	1	-	-	1	1	1	1	1	1	-	-
	Switch for Ventilation Fan 抽氣扇開關掣	-	-	-	-	-	-	1	-	-	-	-	-	-	1	-	-	-	-	-	-	-
	Switch for Thermo Ventilator 浴室寶開關掣	-	-	-	-	-	-	1	-	-	-	-	-	-	1	-	-	-	-	-	-	-
	Switch for Electric Water Heater 電熱水爐開關掣	-	-	-	-	-	-	1	-	-	-	-	-	-	1	-	-	-	-	-	-	-
	Lighting Switch 燈掣	3	1	1	1	-	-	3	2	1	1	1	-	-	3	2	1	1	1	1	-	-
Lighting Point 燈位	1	1	1	1	-	-	1	1	1	1	1	-	-	1	1	1	1	1	1	-	-	
Bedroom 1 睡房 1	Switch for Air-Conditioner (Indoor Unit) 空調機(室內機)開關掣	1	-	-	-	-	-	-	1	-	-	-	-	-	-	1	-	-	-	-	-	-
	13A Twin Socket Outlet 13A雙位電插座	2	-	-	-	-	-	-	2	-	-	-	-	-	-	2	-	-	-	-	-	-
	TV & FM Outlet 電視及電台插座	1	-	-	-	-	-	-	1	-	-	-	-	-	-	1	-	-	-	-	-	-
	Telephone Outlet 電話插座	1	-	-	-	-	-	-	1	-	-	-	-	-	-	1	-	-	-	-	-	-
	Lighting Switch 燈掣	2	-	-	-	-	-	-	1	-	-	-	-	-	-	1	-	-	-	-	-	-
	Lighting Point 燈位	1	-	-	-	-	-	-	1	-	-	-	-	-	-	1	-	-	-	-	-	-

The Vendor undertakes that if lifts or appliances of the specified brand name or model number are not installed in the Phase, lift or appliances of comparable quality will be installed.

Notes :

- 4/F, 13/F, 14/F and 24/F are omitted.
- "1, 2," denotes the quantity of such provision(s) provided in the residential unit.
- The quantity of the lighting switch shown in the schedule denotes the quantity of switch button(s).
- "-" denotes "Not Provided".

賣方承諾如期數中沒有安裝指明的品牌名稱或產品型號的升降機或設備，便會安裝品質相約的升降機或設備。

附註：

- 不設4樓、13樓、14樓及24樓。
- 「1, 2,"表示提供於該住宅單位內的裝置數量。
- 說明表所顯示的燈掣數量是表示燈掣按鈕的數量。
- 「-」代表「不提供」。

Schedule of Mechanical & Electrical Provisions of Residential Units 住宅單位機電裝置數量說明表

Location 位置	Appliance 設備	Phase 3 Tower 1(1B) 第3期第1座(1B)																			
		1/F 1樓						2/F - 3/F, 5/F - 12/F, 15/F - 23/F, 25/F - 30/F 2樓至3樓、5樓至12樓、15樓至23樓、25樓至30樓						31/F - 32/F 31樓至32樓							
		A	B	C	D	E	F	G	A	B	C	D	E	F	G	A	B	C	D	E	F
Bathroom 浴室	13A Single Socket Outlet 13A單位電插座	2	2	2	2	2	2	2	2	2	2	2	2	2	2	2	2	2	2	2	2
	Socket Outlet for Telecom Equipment 電訊設備電插座	-	2	2	2	2	2	2	-	2	2	2	2	2	2	-	2	2	2	2	2
	Connection Point for Cabinet Light 櫃燈接線位	1	1	1	1	1	1	1	1	1	1	1	1	1	1	1	1	1	1	1	1
	Connection Point for Ventilation Fan 抽氣扇接線位	1	1	1	1	1	1	1	1	1	1	1	1	1	1	1	1	1	1	1	1
	Connection Point for Thermo Ventilator 浴室寶接線位	1	1	1	1	1	1	1	1	1	1	1	1	1	1	1	1	1	1	1	1
	Connection Point for Electric Water Heater 電熱水爐接線位	-	1	1	1	1	1	1	-	1	1	1	1	1	1	-	1	1	1	1	1
	Electric Water Heater Remote Control 電熱水爐溫度控制	-	1	1	1	1	1	1	-	1	1	1	1	1	1	-	1	1	1	1	1
	Gas Water Heater Remote Control 煤氣熱水爐溫度控制	1	-	-	-	-	-	-	1	-	-	-	-	-	-	1	-	-	-	-	-
	Lighting Point 燈位	5	5	5	5	5	5	5	5	5	5	5	5	5	5	5	5	5	5	5	5
Kitchen and Open Kitchen 廚房及 開放式廚房	Switch for Telecom Equipment 電訊設備開關掣	1	1	1	1	1	1	1	1	1	1	1	1	1	1	1	1	1	1	1	1
	Socket Outlet for Telecom Equipment 電訊設備電插座	2	-	-	-	-	-	-	2	-	-	-	-	-	-	2	-	-	-	-	-
	Socket Outlet for Cooker Hood 抽油煙機電插座	1	1	1	1	1	1	1	1	1	1	1	1	1	1	1	1	1	1	1	1
	Socket Outlet for Refrigerator 雪櫃電插座	1	1	1	1	1	1	1	1	1	1	1	1	1	1	1	1	1	1	1	1
	Socket Outlet for Washer Dryer 洗衣乾衣機電插座	1	1	1	1	1	1	1	1	1	1	1	1	1	1	1	1	1	1	1	1
	Connection Point for Cabinet Light 櫃燈接線位	1	-	-	-	-	-	-	1	-	-	-	-	-	-	1	-	-	-	-	-
	Connection Point for Ventilation Fan 抽氣扇接線位	1	-	-	-	-	-	-	1	-	-	-	-	-	-	1	-	-	-	-	-
	Connection Point for Combi-Steam Oven 蒸焗爐接線位	1	1	1	1	1	1	1	1	1	1	1	1	1	1	1	1	1	1	1	1
	Connection Point for Induction Hob 電磁煮食爐接線位	1	1	1	1	1	1	1	1	1	1	1	1	1	1	1	1	1	1	1	1
	Switch for Combi-Steam Oven 蒸焗爐開關掣	1	1	1	1	1	1	1	1	1	1	1	1	1	1	1	1	1	1	1	1
	Switch for Induction Hob 電磁煮食爐開關掣	1	1	1	1	1	1	1	1	1	1	1	1	1	1	1	1	1	1	1	1
	Connection Point for Gas Water Heater 煤氣熱水爐接線位	1	-	-	-	-	-	-	1	-	-	-	-	-	-	1	-	-	-	-	-

The Vendor undertakes that if lifts or appliances of the specified brand name or model number are not installed in the Phase, lift or appliances of comparable quality will be installed.

Notes :

- 4/F, 13/F, 14/F and 24/F are omitted.
- "1, 2," denotes the quantity of such provision(s) provided in the residential unit.
- The quantity of the lighting switch shown in the schedule denotes the quantity of switch button(s).
- "-" denotes "Not Provided".

賣方承諾如期數中沒有安裝指明的品牌名稱或產品型號的升降機或設備，便會安裝品質相約的升降機或設備。

附註：

- 不設4樓、13樓、14樓及24樓。
- 「1, 2,"表示提供於該住宅單位內的裝置數量。
- 說明表所顯示的燈掣數量是表示燈掣按鈕的數量。
- 「-」代表「不提供」。

Schedule of Mechanical & Electrical Provisions of Residential Units 住宅單位機電裝置數量說明表

Location 位置	Appliance 設備	Phase 3 Tower 1(1B) 第3期第1座(1B)																			
		1/F 1樓						2/F - 3/F, 5/F - 12/F, 15/F - 23/F, 25/F - 30/F 2樓至3樓、5樓至12樓、15樓至23樓、25樓至30樓						31/F - 32/F 31樓至32樓							
		A	B	C	D	E	F	G	A	B	C	D	E	F	G	A	B	C	D	E	F
Kitchen and Open Kitchen 廚房及 開放式廚房	Door Chime 門鈴	1	-	-	-	-	-	-	1	-	-	-	-	-	-	1	-	-	-	-	-
	Lighting Point 燈位	3	2	2	2	2	2	2	3	2	2	2	2	2	2	3	2	2	2	2	2
	Miniature Circuit Breakers Board 總電掣箱	1	1	1	1	1	1	1	1	1	1	1	1	1	1	1	1	1	1	1	1
Balcony 露台	Lighting Point 燈位	-	-	-	-	-	-	-	1	1	1	1	1	1	1	1	1	1	1	1	1
Utility Platform 工作平台	Lighting Point 燈位	-	-	-	-	-	-	-	1	-	-	-	-	-	-	1	-	-	-	-	-
Flat Roof 平台	13A Watertight Socket Outlet 13A防水電插座	5	2	2	2	1	1	1	-	-	-	-	-	-	-	-	-	-	-	-	-
	Lighting Point 燈位	11	5	5	5	4	4	5	-	-	-	-	-	-	-	-	-	-	-	-	-

The Vendor undertakes that if lifts or appliances of the specified brand name or model number are not installed in the Phase, lift or appliances of comparable quality will be installed.

Notes :

- 4/F, 13/F, 14/F and 24/F are omitted.
- "1, 2," denotes the quantity of such provision(s) provided in the residential unit.
- The quantity of the lighting switch shown in the schedule denotes the quantity of switch button(s).
- "-" denotes "Not Provided".

賣方承諾如期數中沒有安裝指明的品牌名稱或產品型號的升降機或設備，便會安裝品質相約的升降機或設備。

附註：

- 不設4樓、13樓、14樓及24樓。
- 「1, 2,"表示提供於該住宅單位內的裝置數量。
- 說明表所顯示的燈掣數量是表示燈掣按鈕的數量。
- 「-」代表「不提供」。

Schedule of Mechanical & Electrical Provisions of Residential Units 住宅單位機電裝置數量說明表

Location 位置	Appliance 設備	Phase 3 Tower 2 第3期第2座									
		1/F 1樓					2/F - 3/F, 5/F - 12/F, 15/F - 23/F, 25/F - 32/F 2樓至3樓、5樓至12樓、15樓至23樓、25樓至32樓				
		A	B	C	D	E	A	B	C	D	E
Main Entrance 大門入口	Door Chime Push Button 門鈴按鈕	1	1	1	1	1	1	1	1	1	1
Living Room and Dining Room 客廳及飯廳	Switch for Air-Conditioner (Indoor Unit) 空調機(室內機)開關掣	1	1	1	1	1	1	1	1	1	1
	13A Twin Socket Outlet 13A雙位電插座	2	1	2	1	2	2	1	2	1	2
	13A Twin Socket Outlet (with USB Port) 雙位電插座(附有USB接口)	2	2	2	2	2	2	2	2	2	2
	TV & FM Outlet 電視及電台插座	2	2	2	2	2	2	2	2	2	2
	Telephone Outlet 電話插座	2	2	2	2	2	2	2	2	2	2
	Connection Point for Cabinet Light 櫃燈接線位	-	1	1	1	-	-	1	1	1	-
	Switch for Ventilation Fan for Bathroom 浴室抽氣扇開關掣	1	1	1	1	1	1	1	1	1	1
	Switch for Ventilation Fan for Kitchen 廚房抽氣扇開關掣	1	-	-	-	1	1	-	-	-	1
	Switch for Thermo Ventilator 浴室寶開關掣	1	1	1	1	1	1	1	1	1	1
	Switch for Gas Water Heater 煤氣熱水爐開關掣	1	-	-	-	1	1	-	-	-	1
	Switch for Electric Water Heater 電熱水爐開關掣	-	1	1	1	-	-	1	1	1	-
	Video Door Phone 視像對講機	1	1	1	1	1	1	1	1	1	1
	Door Chime 門鈴	-	1	1	1	-	-	1	1	1	-
	Lighting Switch 燈掣	12	11	12	11	12	11	10	11	10	11
Lighting Point 燈位	5	3	5	3	5	5	3	5	3	5	
Master Bedroom 主人睡房	Switch for Air-Conditioner (Indoor Unit) 空調機(室內機)開關掣	1	1	1	1	1	1	1	1	1	1
	13A Twin Socket Outlet 13A雙位電插座	1	1	1	1	1	1	1	1	1	1
	13A Twin Socket Outlet (with USB Port) 13A雙位電插座(附有USB接口)	1	1	1	1	1	1	1	1	1	1
	TV & FM Outlet 電視及電台插座	1	1	1	1	1	1	1	1	1	1
	Telephone Outlet 電話插座	1	1	1	1	1	1	1	1	1	1
	Lighting Switch 燈掣	2	1	3	1	3	2	1	2	1	2
	Lighting Point 燈位	1	1	1	1	1	1	1	1	1	1

The Vendor undertakes that if lifts or appliances of the specified brand name or model number are not installed in the Phase, lift or appliances of comparable quality will be installed.

Notes :

- 4/F, 13/F, 14/F and 24/F are omitted.
- "1, 2," denotes the quantity of such provision(s) provided in the residential unit.
- The quantity of the lighting switch shown in the schedule denotes the quantity of switch button(s).
- "-" denotes "Not Provided".

賣方承諾如期數中沒有安裝指明的品牌名稱或產品型號的升降機或設備，便會安裝品質相約的升降機或設備。

附註：

- 不設4樓、13樓、14樓及24樓。
- 「1, 2,"表示提供於該住宅單位內的裝置數量。
- 說明表所顯示的燈掣數量是表示燈掣按鈕的數量。
- 「-」代表「不提供」。

Schedule of Mechanical & Electrical Provisions of Residential Units 住宅單位機電裝置數量說明表

Location 位置	Appliance 設備	Phase 3 Tower 2 第3期第2座									
		1/F 1樓					2/F - 3/F, 5/F - 12/F, 15/F - 23/F, 25/F - 32/F 2樓至3樓、5樓至12樓、15樓至23樓、25樓至32樓				
		A	B	C	D	E	A	B	C	D	E
Bedroom 1 睡房 1	Switch for Air-Conditioner (Indoor Unit) 空調機(室內機)開關掣	1	-	1	-	1	1	-	1	-	1
	13A Twin Socket Outlet 13A雙位電插座	2	-	2	-	2	2	-	2	-	2
	TV & FM Outlet 電視及電台插座	1	-	1	-	1	1	-	1	-	1
	Telephone Outlet 電話插座	1	-	1	-	1	1	-	1	-	1
	Lighting Switch 燈掣	2	-	1	-	2	1	-	1	-	1
	Lighting Point 燈位	1	-	1	-	1	1	-	1	-	1
Bathroom 浴室	13A Single Socket Outlet 13A單位電插座	2	2	2	2	2	2	2	2	2	2
	Socket Outlet for Telecom Equipment 電訊設備電插座	-	2	2	2	-	-	2	2	2	-
	Connection Point for Cabinet Light 櫃燈接線位	1	1	1	1	1	1	1	1	1	1
	Connection Point for Ventilation Fan 抽氣扇接線位	1	1	1	1	1	1	1	1	1	1
	Connection Point for Thermo Ventilator 浴室寶接線位	1	1	1	1	1	1	1	1	1	1
	Connection Point for Electric Water Heater 電熱水爐接線位	-	1	1	1	-	-	1	1	1	-
	Electric Water Heater Remote Control 電熱水爐溫度控制	-	1	1	1	-	-	1	1	1	-
	Gas Water Heater Remote Control 煤氣熱水爐溫度控制	1	-	-	-	1	1	-	-	-	1
	Lighting Point 燈位	5	5	5	5	5	5	5	5	5	5
Kitchen and Open Kitchen 廚房及 開放式廚房	Switch for Telecom Equipment 電訊設備開關掣	1	1	1	1	1	1	1	1	1	1
	Socket Outlet for Telecom Equipment 電訊設備電插座	2	-	-	-	2	2	-	-	-	2
	Socket Outlet for Cooker Hood 抽油煙機電插座	1	1	1	1	1	1	1	1	1	1
	Socket Outlet for Refrigerator 雪櫃電插座	1	1	1	1	1	1	1	1	1	1
	Socket Outlet for Washer Dryer 洗衣乾衣機電插座	1	1	1	1	1	1	1	1	1	1
	13A Twin Socket Outlet 13A雙位電插座	2	1	2	1	2	2	1	2	1	2

The Vendor undertakes that if lifts or appliances of the specified brand name or model number are not installed in the Phase, lift or appliances of comparable quality will be installed.

Notes :

- 4/F, 13/F, 14/F and 24/F are omitted.
- "1, 2," denotes the quantity of such provision(s) provided in the residential unit.
- The quantity of the lighting switch shown in the schedule denotes the quantity of switch button(s).
- "-" denotes "Not Provided".

賣方承諾如期數中沒有安裝指明的品牌名稱或產品型號的升降機或設備，便會安裝品質相約的升降機或設備。

附註：

- 不設4樓、13樓、14樓及24樓。
- 「1, 2,"表示提供於該住宅單位內的裝置數量。
- 說明表所顯示的燈掣數量是表示燈掣按鈕的數量。
- 「-」代表「不提供」。

Schedule of Mechanical & Electrical Provisions of Residential Units 住宅單位機電裝置數量說明表

Location 位置	Appliance 設備	Phase 3 Tower 2 第3期第2座									
		1/F 1樓					2/F - 3/F, 5/F - 12/F, 15/F - 23/F, 25/F - 32/F 2樓至3樓、5樓至12樓、15樓至23樓、25樓至32樓				
		A	B	C	D	E	A	B	C	D	E
Kitchen and Open Kitchen 廚房及 開放式廚房	Connection Point for Cabinet Light 櫃燈接線位	1	-	-	-	1	1	-	-	-	1
	Connection Point for Ventilation Fan 抽氣扇接線位	1	-	-	-	1	1	-	-	-	1
	Connection Point for Combi-Steam Oven 蒸焗爐接線位	1	1	1	1	1	1	1	1	1	1
	Connection Point for Induction Hob 電磁煮食爐接線位	1	1	1	1	1	1	1	1	1	1
	Switch for Combi-Steam Oven 蒸焗爐開關掣	1	1	1	1	1	1	1	1	1	1
	Switch for Induction Hob 電磁煮食爐開關掣	1	1	1	1	1	1	1	1	1	1
	Connection Point for Gas Water Heater 煤氣熱水爐接線位	1	-	-	-	1	1	-	-	-	1
	Door Chime 門鈴	1	-	-	-	1	1	-	-	-	1
	Lighting Point 燈位	3	2	2	2	3	3	2	2	2	3
Miniature Circuit Breakers Board 總電掣箱	1	1	1	1	1	1	1	1	1	1	
Store 儲物房	Switch for Air-Conditioner (Indoor Unit) 空調機(室內機)開關掣	1	-	-	-	-	1	-	-	-	-
	13A Single Socket Outlet 13A單位電插座	1	-	-	-	-	1	-	-	-	-
	Telephone Outlet 電話插座	1	-	-	-	-	1	-	-	-	-
	Lighting Switch 燈掣	2	-	-	-	-	1	-	-	-	-
	Lighting Point 燈位	1	-	-	-	-	1	-	-	-	-
Balcony 露台	Lighting Point 燈位	-	-	-	-	-	1	1	1	1	1
Utility Platform 工作平台	Lighting Point 燈位	-	-	-	-	-	1	-	1	-	1
Flat Roof 平台	13A Watertight Socket Outlet 13A防水電插座	1	1	2	2	4	-	-	-	-	-
	Lighting Point 燈位	7	4	6	5	13	-	-	-	-	-

The Vendor undertakes that if lifts or appliances of the specified brand name or model number are not installed in the Phase, lift or appliances of comparable quality will be installed.

Notes :

- 4/F, 13/F, 14/F and 24/F are omitted.
- "1, 2," denotes the quantity of such provision(s) provided in the residential unit.
- The quantity of the lighting switch shown in the schedule denotes the quantity of switch button(s).
- "-" denotes "Not Provided".

賣方承諾如期數中沒有安裝指明的品牌名稱或產品型號的升降機或設備，便會安裝品質相約的升降機或設備。

附註：

- 不設4樓、13樓、14樓及24樓。
- 「1, 2,"表示提供於該住宅單位內的裝置數量。
- 說明表所顯示的燈掣數量是表示燈掣按鈕的數量。
- 「-」代表「不提供」。

24 SERVICE AGREEMENTS 服務協議

Potable and flushing water is supplied by Water Supplies Department.
Electricity is supplied by CLP Power Hong Kong Limited.
Towngas is supplied by The Hong Kong and China Gas Company Limited.

食水及沖廁水由水務署供應。
電力由中華電力有限公司供應。
煤氣由香港中華煤氣有限公司供應。

25 GOVERNMENT RENT 地稅

The Vendor is liable for the Government rent payable for the specified residential properties from the date of the Land Grant up to and including the date of the assignments of the specified residential properties.

賣方有法律責任繳付有關指明住宅物業由批地文件之日期起計直至該等指明住宅物業之轉讓契日期(包括該日)之地稅。

26 MISCELLANEOUS PAYMENTS BY PURCHASER 買方的雜項付款

On the delivery of the vacant possession of the specified residential property to the purchaser, the purchaser is liable to reimburse the Vendor for the deposits for water, electricity and gas.

On that delivery, the purchaser is not liable to pay to the Vendor a debris removal fee.

Note:

On that delivery, the purchaser is liable to pay a debris removal fee to the manager (not the Vendor) of the Phase under the Principal Deed of Mutual Covenant and Management Agreement, and where the Vendor has paid the debris removal fee, the purchaser shall reimburse the Vendor for the same.

在向買方交付指明住宅物業在空置情況下的管有權時，買方須負責向賣方補還水、電力及氣體的按金。

在交付時，買方不須向賣方支付清理廢料的費用。

附註：

在交付時，買方須根據主公共契約及管理協議向期數的管理人(而非賣方)支付清理廢料的費用，而如賣方已支付清理廢料的費用，買方須向賣方補還清理廢料的費用。

27 DEFECT LIABILITY WARRANTY PERIOD 欠妥之處的保養責任期

The Vendor shall, at its own cost and as soon as reasonably practicable after receipt of a written notice served by the purchaser within 6 months after the date of completion of the sale and purchase of any specified residential property, remedy any defects in such property, or its fittings, finishes or appliances incorporated into such property as set out in the agreement for sale and purchase concerned, caused otherwise than by the act or neglect of the purchaser.

凡任何指明住宅物業或於相關買賣合約列出之裝設於該物業內的裝置、裝修物料或設備有欠妥之處，而該欠妥之處並非由買方行為或疏忽造成，則賣方在接獲買方在買賣成交日期後的6個月內送達的書面通知後，須於合理地切實可行的範圍內，盡快自費作出補救。

28 MAINTENANCE OF SLOPES 斜坡維修

Not Applicable

不適用

29 MODIFICATION 修訂

No application to the Government for a modification of the Land Grant for this Phase is underway.

本期數現時並沒有向政府提出申請修訂批地文件。

1. Gondola

Gondola systems of the residential towers in the Phase may operate and park in the airspace above the flat roof or roof, or outside the curtain walls or windows, which form part of a residential property.

2. Noise Mitigation Measures

The following noise mitigation measures will be provided in the Phase:-

Tower	Unit	Floor	Noise mitigation measures
Phase 3 Tower 1(1A)	B	1/F-30/F	1m fin at Bedroom 1
	B	1/F-30/F	Fixed Glazing / Maintenance Window at Bedroom 1
	B	1/F	Self-closing door at Bedroom 2
	B	1/F-30/F	1.4m fin adjoining Bedroom 2
	B	1/F	Fixed Glazing at Bedroom 2
	B	2/F-30/F	Maintenance Window at Bedroom 2
	B	31/F	1.2m high solid wall at flat roof adjoining Living Room and Dining Room
	B	31/F	1.4m fin adjoining Living Room and Dining Room
	B	31/F	Fixed Glazing / Maintenance Window at Living Room and Dining Room
	B	32/F	1.4m fin adjoining Master Ensuite
	B	32/F	1m fin adjoining Master Ensuite
	B	32/F	Fixed Glazing / Maintenance Window at Master Ensuite
	Phase 3 Tower 1(1B)	A	1/F
A		1/F-32/F	1.1m fin adjoining Bedroom 1
A		1/F-32/F	Fixed Glazing / Maintenance Window at Bedroom 1

Remark:

- 4/F, 13/F, 14/F and 24/F are omitted.

1. 吊船

期數住宅大樓之吊船系統可能會在構成住宅物業一部分之平台或天台上空，或幕牆或窗戶外操作或停泊。

2. 噪音緩解措施

期數將提供下列噪音緩解措施：-

座	單位	樓層	噪音緩解措施
第3期 第1座(1A)	B	1樓至30樓	1米隔聲簷於睡房1
	B	1樓至30樓	固定玻璃 / 維修窗於睡房1
	B	1樓	自動關閉門裝置於睡房2
	B	1樓至30樓	1.4米隔聲簷毗連睡房2
	B	1樓	固定玻璃於睡房2
	B	2樓至30樓	維修窗於睡房2
	B	31樓	1.2米高實牆於毗連客廳及飯廳之平台
	B	31樓	1.4米隔聲簷毗連客廳及飯廳
	B	31樓	固定玻璃 / 維修窗於客廳及飯廳
	B	32樓	1.4米隔聲簷毗連主人套房
	B	32樓	1米隔聲簷毗連主人套房
	B	32樓	固定玻璃 / 維修窗於主人套房
	第3期 第1座(1B)	A	1樓
A		1樓至32樓	1.1米隔聲簷毗連睡房1
A		1樓至32樓	固定玻璃 / 維修窗於睡房1

附註：

- 不設4樓、13樓、14樓及24樓。

2. Noise Mitigation Measures

The following noise mitigation measures will be provided in the Phase:-

Tower	Unit	Floor	Noise mitigation measures
Phase 3 Tower 2	A	1/F	Self-closing door at Bedroom 1
	A	1/F-32/F	1m fin adjoining Bedroom 1
	A	1/F-32/F	Fixed Glazing / Maintenance Window at Bedroom 1
	A	1/F	Fixed Glazing at Master Bedroom
	A	2/F-32/F	Maintenance Window at Master Bedroom
	A	1/F-32/F	Self-closing door at Master Bedroom
	A	1/F	Self-closing door at Store
	A	1/F-32/F	Fixed Glazing at Store
	E	1/F	Self-closing door at Bedroom 1
	E	1/F-32/F	1.4m fin adjoining Bedroom 1
	E	1/F	Fixed Glazing at Bedroom 1
	E	2/F-32/F	Maintenance Window at Bedroom 1

Remark:

- 4/F, 13/F, 14/F and 24/F are omitted.

2. 噪音緩解措施

期數將提供下列噪音緩解措施：-

座	單位	樓層	噪音緩解措施
第3期 第2座	A	1樓	自動關閉門裝置於睡房1
	A	1樓至32樓	1米隔聲鰭毗連睡房1
	A	1樓至32樓	固定玻璃 / 維修窗於睡房1
	A	1樓	固定玻璃於主人睡房
	A	2樓至32樓	維修窗於主人睡房
	A	1樓至32樓	自動關閉門裝置於主人睡房
	A	1樓	自動關閉門裝置於儲物房
	A	1樓至32樓	固定玻璃於儲物房
	E	1樓	自動關閉門裝置於睡房1
	E	1樓至32樓	1.4米隔聲鰭毗連睡房1
	E	1樓	固定玻璃於睡房1
	E	2樓至32樓	維修窗於睡房1

附註：

- 不設4樓、13樓、14樓及24樓。

3. Change in the Number of Parking Spaces and Residential Properties in Different Phases

The number of parking spaces and residential properties in the different phases of the Development may change from time to time and may be different from that shown on the general building plans approved as of the date of printing of this sales brochure.

4. Clubhouse & Podium Area Air-Conditioning Outdoor Units

Air-conditioner (Outdoor Units) for Clubhouse and podium areas are installed at the following areas :-

1. Common Flat Roof at 1/F of Phase 3 Tower 2
2. Landscape area on Ground Floor adjacent to Phase 3 Tower 2

These air-conditioners may generate heat and/or sound.

5. Common Parts Inside and/or Abutting the Flat Roof or Roof of the Residential Properties in the Phase

There are areas which are common parts inside or abutting the flat roof and/or roof of some of the residential properties in the Phase. For locations of the said common parts, please refer to the "Floor Plans of Residential Properties in the Phase" Section in this Sales Brochure. Pursuant to the DMC of the Development, the Manager of the Development has the power to enter with or without workmen, equipment or materials at all reasonable times on reasonable notice (except in an emergency) any part of the Development to exercise or carry out any of its powers or duties under the DMC, including without limitation to carry out necessary repairs to the Development or abate any hazard or nuisance which does or may affect the common parts or other owners.

3. 改變不同期數的停車位及住宅物業數目

發展項目不同期數的停車位及住宅物業數目可能不時改變並與本售樓說明書印製日期當時獲批的建築圖則中顯示者不同。

4. 會所及平台層之空調室外機

會所及平台層之空調機(室外機)將裝設於以下位置：

1. 第3期第2座1樓的公用平台
2. 鄰近第3期第2座地下的綠化範圍

該等空調機可能發出熱力及/或聲音。

5. 期數中住宅物業之平台及/或天台內存有或毗連的公用部分

於期數中部分住宅物業之平台及/或天台內存有或毗連屬公用部分之範圍。有關上述公用部分的位置，請參閱本售樓說明書之「期數的住宅物業的樓面平面圖」。根據發展項目公契，發展項目管理人有權經合理預先通知(緊急情況除外)帶同或不帶同工人、設備或材料在任何合理時間內進入發展項目任何部分，以行使或執行其按公契下有的任何權利或義務，包括但不限於對發展項目進行必要的維修或減少對公用部份或其他業主的妨礙或干擾。

6. Inspection and Desilting Works at the Drainage Reserve Areas

Special Condition No.(35)(b) of the Land Grant provides that the Government shall have the right of unrestricted ingress, egress and regress at all times to, from and through the Development for the purposes of laying, inspecting, repairing and maintaining drains, sewers, channels, drainage facilities and all other services running across, through or under the Drainage Reserve Areas (as defined in the “Summary of Land Grant” Section of this Sales Brochure) which the Director of Lands may require or authorize.

Please refer to “Plan Showing the Location of the Promenade Area and Drainage Reserve Areas” in “Information of Public Facilities and Public Open Spaces” Section of this Sales Brochure showing the location of the Drainage Reserve Areas. There are manholes or box culverts within the Drainage Reserve Areas for the purposes of carrying out periodic inspections and desilting works by the Drainage Services Department. During the inspections and desilting works, equipment such as cranes trucks, mechanical plants, pumps etc. may be stationed within the Drainage Reserve Areas which may obstruct the views of the residential properties in the Phase. Such inspections and desilting works may generate sound noise and odour.

6. 渠務專用範圍內之檢查及清淤工作

批地文件特別條件第(35)(b)條訂明政府有權在任何時間不受限制地通行、進出、往返和行經發展項目，以便鋪設、檢查、修理及維修橫貫、穿越渠務專用範圍（其定義見本售樓說明書之「批地文件的摘要」）或位於其下的排水渠、污水渠、渠道、排水設施及地政總署署長指定或批准的所有其他服務設施。

有關渠務專用範圍的位置，請參閱本售樓說明書之「公共設施及公眾休憩用地的資料」內之「海濱廣場範圍及渠務專用範圍位置圖」。渠務專用範圍內有沙井或箱形暗渠，以便渠務署進行週期性的檢查及清淤工作。檢查及清淤工作的進行期間，可能會有貨車式起重機、機械設備、水泵等設備停留在渠務專用範圍內，可能阻礙期數中的住宅物業的景觀。該些檢查及清淤工作可能發出聲音及氣味。

The address of the website designated by the Vendor for the Phase for the purposes of Part 2 of the Residential Properties (First-hand Sales) Ordinance:

www.grandvictoria3.hk

賣方為施行《一手住宅物業銷售條例》第2部而就期數指定的互聯網網站的網址：

www.grandvictoria3.hk

Breakdown of GFA Concessions Obtained for All Features

獲寬免總樓面面積的設施分項

Latest information on breakdown of GFA concessions as shown on the general building plans submitted to and approved by the Building Authority (BA) prior to the printing of the sales brochure is tabulated below. Information marked (#) may be based on information provided by the Authorized Person if the sales brochure is printed prior to submission of the final amendment plans to the BA. The breakdown of GFA concessions may be subject to further changes until final amendment plans are submitted to and approved by the BA prior to the issuance of the occupation permit for the Phase.

於印製售樓說明書前呈交予並已獲建築事務監督批准的一般建築圖則上有關總樓面面積寬免的分項的最新資料，請見下表。如印製售樓說明書時尚未呈交最終修訂圖則予建築事務監督，則有(#)號的資料可以由認可人士提供的資料作為基礎。直至最終修訂圖則於發出期數佔用許可證前呈交予並獲建築事務監督批准前，以下分項資料仍可能有所修改。

Disregarded GFA under Building (Planning) Regulations 23(3)(b) 根據《建築物(規劃)規例》第23(3)(b)條不計算的總樓面面積		Area (m ²) 面積(平方米)
1(#)	Carpark and loading/ unloading area excluding public transport terminus 停車場及上落客貨地方(公共交通總站除外)	-
2	Plant rooms and similar services 機房及相類設施	
2.1(#)	Mandatory feature or essential plant room, area of which is limited by respective Practice Notes for Authorized Persons, Registered Structural Engineers and Registered Geotechnical Engineers (PNAP) or regulation such as lift machine room, telecommunications and broadcasting (TBE) room, refuse storage and material recovery chamber, etc. 所佔面積受相關《認可人士、註冊結構工程師及註冊岩土工程師作業備考》或規例限制的強制性設施或必要機房，例如升降機機房、電訊及廣播設備室、垃圾及物料回收房等	334.565
2.2(#)	Mandatory feature or essential plant room, area of which is NOT limited by any PNAP or regulation such as room occupied solely by fire services installations (FSI) and equipment, meter room, transformer room, potable and flushing water tank, etc. 所佔面積不受任何《認可人士、註冊結構工程師及註冊岩土工程師作業備考》或規例限制的強制性設施或必要機房，例如僅供消防裝置及設備佔用的房間、電錶房、電力變壓房、食水及鹹水缸等	592.859
2.3(#)	Non-mandatory or non-essential plant room such as air-conditioning plant room, air handling unit (AHU) room, etc. 非強制性或非必要機房，例如空調機房、風櫃房等	-

Green Features under Joint Practice Notes 1 and 2 根據聯合作業備考第1及第2號提供的環保設施		
3(#)	Balcony 露台	435.613
4	Wider common corridor and lift lobby 加闊的公用走廊及升降機大堂	42.700
5	Communal sky garden 公用空中花園	-
6	Acoustic fin 隔聲鰭	-
7	Wing wall, wind catcher and funnel 翼牆、捕風器及風斗	-
8(#)	Non-structural prefabricated external wall 非結構預製外牆	186.053
9(#)	Utility platform 工作平台	127.500
10	Noise barrier 隔音屏障	-
Amenity Features 適意設施		
11(#)	Counter, office, store, guard room and lavatory for watchman and management staff, Owners' Corporation Office 供保安人員和管理處員工使用的櫃檯、辦公室、儲物房、警衛室和廁所、業主立案法團辦公室	-
12(#)	Residential Recreational facilities including void, plant room, swimming pool filtration plant room, covered walkway etc serving solely the recreational facilities 住宅康樂設施，包括僅供康樂設施使用的中空、機房、游泳池的濾水器機房、有蓋人行道等	-
13(#)	Covered landscaped and play area 有上蓋的園景區及遊樂場	-
14(#)	Horizontal screens/covered walkways, trellis 橫向屏障/有蓋人行道、花棚	-
15	Larger lift shaft 擴大升降機井道	297.953
16	Chimney shaft 煙囪管道	-
17	Other non-mandatory or non-essential plant room, such as boiler room, satellite master antenna television (SMATV) room 其他非強制性或非必要機房，例如鍋爐房、衛星電視共用天線房	-

18(#)	Pipe duct, air duct for mandatory feature or essential plant room 強制性設施或必要機房所需的管槽、氣槽	123.152
19(#)	Pipe duct, air duct for non-mandatory or non-essential plant room 非強制性設施或非必要機房所需的管槽、氣槽	-
20	Plant room, pipe duct, air duct for environmentally friendly system and feature 環保系統及設施所需的機房、管槽及氣槽	-
21	Void in duplex domestic flat and house 複式住宅單位及洋房的中空	-
22	Projections such as air-conditioning box and platform with a projection of more than 750 mm from the external wall 伸出物，如空調機箱及伸出外牆超過750毫米的平台	-
Other Exempted Items 其他項目		
23(#)	Refuge floor including refuge floor cum sky garden 庇護層，包括庇護層兼空中花園	-
24	Other projections 其他伸出物	-
25(#)	Public transport terminus 公共交通總站	-
26	Party structure and common staircase 共用構築物及樓梯	-
27(#)	Horizontal area of staircase, lift shaft and vertical duct solely serving floor accepted as not being accountable for GFA 僅供獲接納不計入總樓面面積的樓層使用的樓梯、升降機槽及垂直管道的水平面積	233.374
28	Public passage 公眾通道	-
29	Covered set back area 因建築物後移導致的覆蓋面積	-
Bonus GFA 額外總樓面面積		
30	Bonus GFA 額外總樓面面積	-

Note:

The above table is based on the requirements as stipulated in the Practice Note for Authorized Persons, Registered Structural Engineers and Registered Geotechnical Engineers ADM-2 issued by the Buildings Department. The Buildings Department may revise such requirements from time to time as appropriate.

附註：

上述表格是根據屋宇署所發出的《認可人士、註冊結構工程師及註冊岩土工程師作業備考》ADM-2規定的要求而制訂的。屋宇署會按實際需要不時更改有關要求。

Environmental Assessment of the Building
建築物的環境評估Estimated Energy Performance or Consumption for the Common Parts of the Phase
期數的公用部分的預計能量表現或消耗

Latest information on the estimated energy performance or consumption for the common parts of the Phase as submitted to the Building Authority prior to the printing of the sales brochure:
於印製售樓說明書前呈交予建築事務監督期數的公用部份的預計能量表現或消耗的最近期資料：

Part I 第I部分					
Provision of Central Air Conditioning 提供中央空調		Yes 是			
Provision of Energy Efficient Features 提供具能源效益的設施		Yes 是			
Energy Efficient Features proposed 擬安裝的具能源效益的設施：-		1. High Efficient Air Conditioning Units 高效能空調機 2. High Efficient Lighting System 高效能照明系統			
Part II: The predicted annual energy use of the proposed building / part of building ^(Note 1) 第II部分：擬興建樓宇/部分樓宇預計每年能源消耗量 ^(註1) ：-					
Location 位置	Internal Floor Area Served (m ²) 使用有關裝置的內部樓面面積 (平方米)	Annual Energy Use of Baseline Building ^(Note 2) 基線樓宇 ^(註2) 每年能源消耗量		Annual Energy Use of Proposed Building 擬興建樓宇每年能源消耗量	
		Electricity kWh / m ² / annum 電力 千瓦小時/平方米/年	Town Gas / LPG unit / m ² / annum 煤氣/石油氣 用量單位/平方米/年	Electricity kWh / m ² / annum 電力 千瓦小時/平方米/年	Town Gas / LPG unit / m ² / annum 煤氣/石油氣 用量單位/平方米/年
Tower (Area served by central building services installation ^(Note 3)) 塔樓 (有使用中央屋宇裝備裝置 ^(註3) 的部分)	3385	89	-	87	-

Part III: The following installation(s) are designed in accordance with the relevant Codes of Practices published by the Electrical & Mechanical Services Department (EMSD) 第III部分：以下裝置乃按機電工程署公布的相關實務守則設計：-			
Type of Installations 裝置類型	YES 是	NO 否	N/A 不適用
Lighting Installations 照明裝置	✓		
Air Conditioning Installations 空調裝置	✓		
Electrical Installations 電力裝置	✓		
Lift & Escalator Installations 升降機及自動梯的裝置	✓		
Performance-based Approach 以總能源為本的方法			✓

Notes:

- In general, the lower the estimated “Annual Energy Use” of the building, the more efficient of the building in terms of energy use. For example, if the estimated “annual energy use of proposed building” is less than the estimated “annual energy use of baseline building”, it means the predicted use of energy is more efficient in the proposed building than in the baseline building. The larger the reduction, the greater the efficiency.

The predicted annual energy use in terms of electricity consumption (kWh/m²/annum) and town gas/LPG consumption (unit/m²/annum), of the Phase by the internal floor area served, where:

- “total annual energy use” has the same meaning of “annual energy use” under Section 4 and Appendix 8 of the BEAM Plus for New Buildings (current version); and
 - “internal floor area”, in relation a building, a space or a unit means the floor area of all enclosed space measured to the internal faces of enclosing external and/or party walls.
- “Baseline Building” has the same meaning as “Baseline Building Model (zero-credit benchmark)” under Section 4 and Appendix 8 of the BEAM Plus for New Building.
 - “Central Building Services Installation” has the same meaning as that in the Code of Practice for Energy Efficiency of Building Services Installations in Buildings.

註腳：

- 一般而言，一棟樓宇的預計“每年能源消耗量”愈低，其節約能源的效益愈高。如一棟樓宇預計的“每年能源消耗量”低於該樓宇的“基線樓宇每年能源消耗量”，則代表預計該樓宇的能源應用較其基線樓宇有效，削減幅度愈大則代表有關樓宇能源節約的效益愈高。

預計每年能源消耗量[以耗電量(千瓦小時/平方米/年)及煤氣/石油氣消耗量(用量單位/平方米/年)計算，指將期數的每年能源消耗總量除以使用有關裝置的內部樓面面積所得出的商，其中：-

- “每年能源消耗量”與新建樓宇BEAM Plus標準(現行版本)第4節及附錄8中的「年能源消耗」具有相同涵義；及
 - 樓宇、空間或單位的“內部樓面面積”，指外牆及/或共用牆的內壁之內表面起量度出來的樓面面積。
- “基準樓宇”與新建樓宇BEAM Plus標準(現行版本)第4節及附錄8中的“基準建築物模式(零分標準)”具有相同涵義。
 - “中央屋宇裝備裝置”與樓宇的屋宇裝備裝置能源效益實務守則中的涵義相同。

1. The purchaser is required to agree with the Vendor in the Agreement for Sale and Purchase to the effect that other than entering into a mortgage or charge, the purchaser will not nominate any person to take up the Assignment of the Residential Unit specified in the Agreement for Sale and Purchase, sub-sell that Residential Unit or transfer the benefit of the Agreement for Sale and Purchase of that Residential Unit in any manner whatsoever or enter into any agreement so to do before completion of the sale and purchase and execution of the Assignment.
 2. If the Vendor, at the request of the purchaser under an Agreement for Sale and Purchase, agrees (at its own discretion) to cancel the Agreement for Sale and Purchase or the obligations of the purchaser under the Agreement for Sale and Purchase, the Vendor is entitled to retain the sum of five percent (5%) of the total purchase price of the Residential Unit specified in the Agreement for Sale and Purchase and the purchaser will in addition pay or reimburse (as the case may be) to the Vendor all legal costs, charges and disbursements (including any stamp duty) in connection with the cancellation of the Agreement for Sale and Purchase.
 3. The Vendor will pay or has paid (as the case may be) all outstanding Government rent in respect of the land on which the Development is in the course of being erected, from the date of the Land Grant up to and including the date of the respective Assignments to the purchasers.
 4. The purchaser who has signed an Agreement for Sale and Purchase has the right of access to and will, upon his request, be provided with a hard copy of an updated record of information as to the total construction costs and the total professional fees to complete the Phase as well as the total construction costs and the total professional fees expended and paid as at the end of the calendar month preceding the month at which the request is made subject to payment of a nominal fee of not more than HK\$100 per request.
 5. For information relating to the Promenade Area (as referred to in Special Condition No. (10) of the Land Grant), please refer to the sections “Summary of Land Grant” and “Information on Public Facilities and Public Open Spaces”.
 6. For information relating to the Right of Way Area (as referred to in Special Condition No. (21) of the Land Grant), please refer to the section “Summary of Land Grant”.
1. 買方須於正式買賣合約（「買賣合約」）下與賣方約定，除訂立按揭或押記外，在買賣完成及簽署轉讓契前，買方不得提名任何人士接受買賣合約指明之住宅單位之轉讓、轉售該住宅單位或以任何形式轉移該住宅單位之買賣合約之權益，或訂立任何有關上述提名、轉售或轉移權益之協議。
 2. 若賣方應買賣合約下買方要求同意(同意與否賣方有酌情權決定)取消買賣合約或買賣合約下買方之責任，賣方有權保留等同買賣合約指明之住宅單位總售價5%之金額，另買方須向賣方繳付或補還(視屬何情況而定)所有與取消買賣合約有關之法律費用、收費及開銷(包括任何印花稅)。
 3. 賣方將會或已經(視屬何情況而定)支付所有關於發展項目在其上興建之土地於批地文件日期起計至相關買家轉讓契日期(包括該兩日)期間之未付地稅。
 4. 已簽署買賣合約之買方有權查閱，亦可要求取得有關完成興建期數所需的總建築費及總專業服務費與及截至提出該要求之前一個月月底為止已花費及支付的總建築費及總專業服務費之最新資料副本一份，惟買方須就每項上述獲得副本之要求繳付不超過港幣一百元之象徵式費用。
 5. 就批地文件特別條件第(10)條提及的海濱廣場範圍的事宜，請參閱「批地文件的摘要」一節及「公共設施及公眾休憩用地的資料」一節。
 6. 就批地文件特別條件第(21)條提及的通道權範圍的事宜，請參閱「批地文件的摘要」一節。

34 DATE OF PRINTING OF SALES BROCHURE 售樓說明書印製日期

Date of printing of Sales Brochure: 13 March 2021

售樓說明書印製日期：2021年3月13日

35 POSSIBLE FUTURE CHANGES 日後可能出現的改變

There may be future changes to the Phase and the surrounding areas.

期數及其周邊地區日後可能出現改變。

EXAMINATION RECORD
檢視記錄

Examination / Revision Date 檢視/修改日期	Page Number 頁次	Revision Made 所作修改
30 March 2021 2021年3月30日	33, 35	Floor Plans of Residential Properties in the Phase are updated 更新期數的住宅物業的樓面平面圖
1 April 2021 2021年4月1日	22, 24, 26, 28, 30, 32, 34, 36, 38, 40, 42	Floor Plans of Residential Properties in the Phase are updated 更新期數的住宅物業的樓面平面圖
	94, 95	Cross-Section Plan of Building in the Phase are updated 更新期數中的建築物的橫截面圖
	96-101	Elevation Plan are updated 更新立面圖
	104, 108	Fitting, Finishes and Appliances are updated 更新裝置、裝修物料及設備

